

CL200 Passage & Privacy

The CL200 range is durable sliding door hardware suitable for residential, commercial, and hospitality applications.

Privacy handles incorporate a patented magnetic latching system*, ensuring a smooth locking action. The symmetrical design makes handling easy - simply ensure the side handles are the desired orientation when fitting.

Two face plate widths are available. Handles can be adjusted to suit doors from 33 - 40mm or 40 - 46mm thick.

*Patent pending

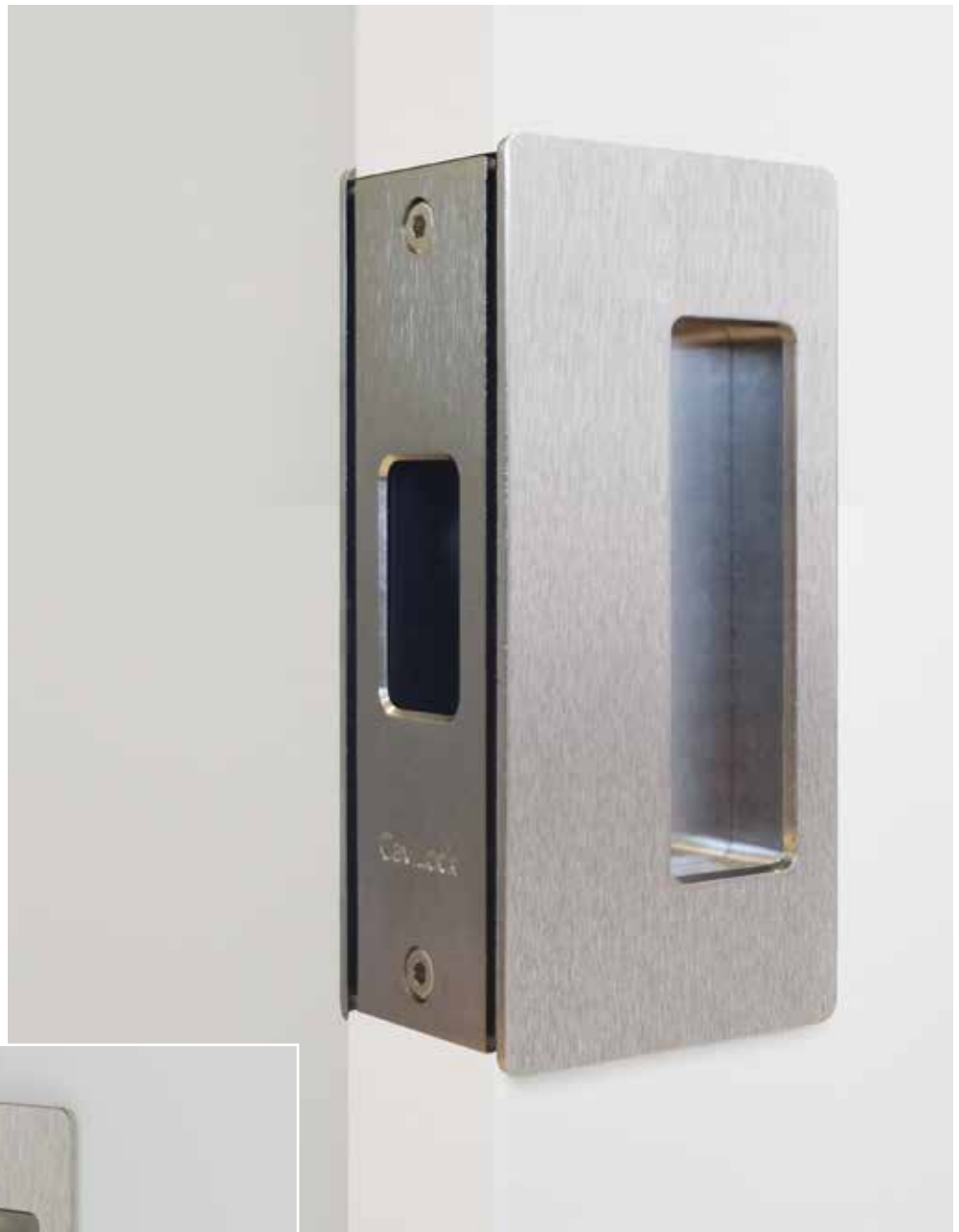

CaviLock CL200 Passage handle in Satin Chrome



CL200 Magnetic Privacy handle in Satin Nickel

Features

- ▮ Passage, Privacy and Bi-Parting options are available in a range of finishes.
- ▮ Suitable for use on timber or aluminium doors
- ▮ Integrated snib button allows more space in the side pull.
- ▮ Entire striker is encased by the finger pull, enabling the door to close completely flush.
- ▮ Large finger pull has more depth for greater purchase.
- ▮ Simple installation with easy to follow instructions.

Dimensions

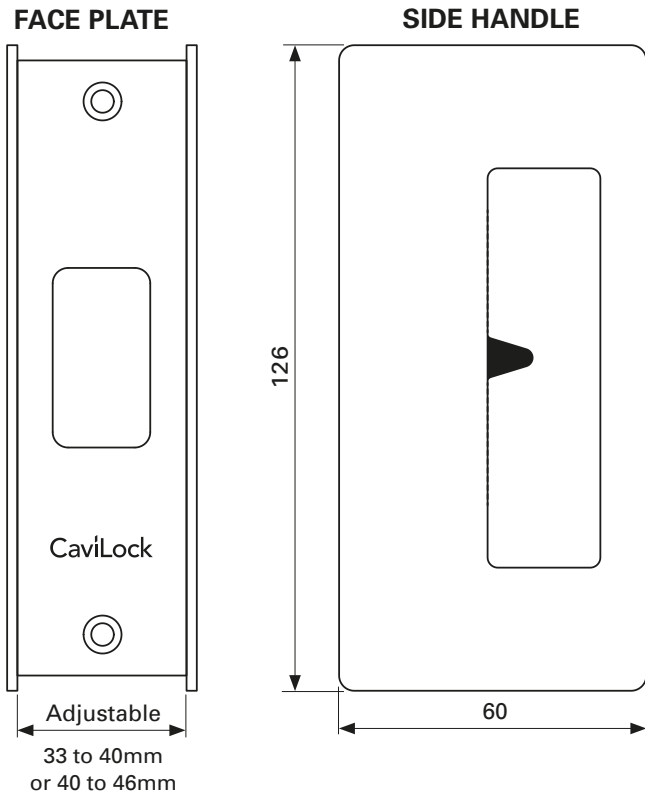

HANDLE CUTOUT

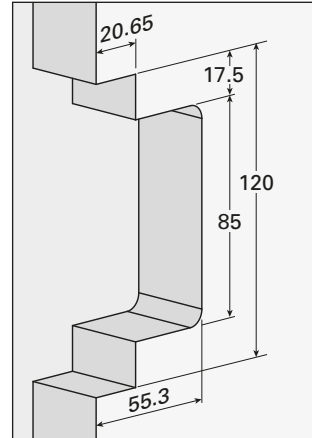

STRIKER

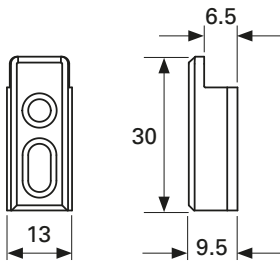

Configurations

CL205 A - Passage (non-latching)

Non-magnetic

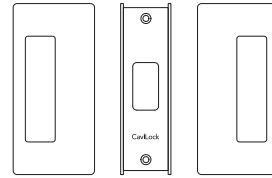

Passage handles are suitable for situations where locking or latching is not required. These handles do not have a striker or magnet.

CL205 D - Privacy Snib/Emergency

Magnetic Latch

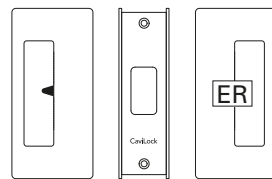

Privacy handles are supplied with a triangular shaped Snib on one side and Snib, Blank or Emergency Release on the other side.



Privacy Snib Button



Emergency Release

Snib/Snib

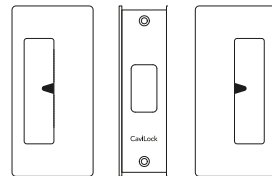

Snib One Side

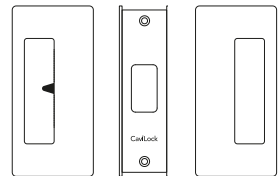

An alternative flush snib is available. Lead time applies.

Finish Options



Satin Chrome Bright Chrome Satin Nickel Oil Rubbed Bronze Matte Black

Non-standard finishes are available on request. Longer lead times and surcharges will apply.

CL205 C - Bi-Parting Mate (to latch with Privacy)

Magnetic Latch

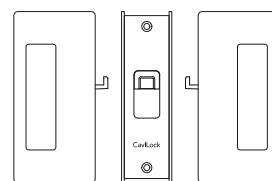

The Bi-Parting mate includes a striker on the face plate to enable it to magnetically latch with a privacy handle.

For Bi-Parting passage doors, order two single passage handles.

Drawings & pictures are not to scale. All dimensions in millimetres. © Cavity Sliders Limited.

Auckland Head Office
T 09 276 0800
info@csfordoors.co.nz

Bay of Plenty / Waikato
T 07 928 0800
salesbop@csfordoors.co.nz

Christchurch
T 03 348 6158
saleschch@csfordoors.co.nz

Another quality product from:

FOR DOORS