



ENTRANCE HANDLES

————— V 2 —————



MDZ-2009
GECA 28-2006-
FURNITURE AND FITTINGS

Entrance Handles Fixing Options

GD FIX - glass doors

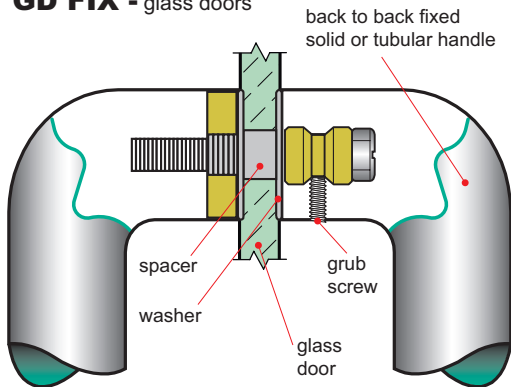

TM FIX - timber or metal doors

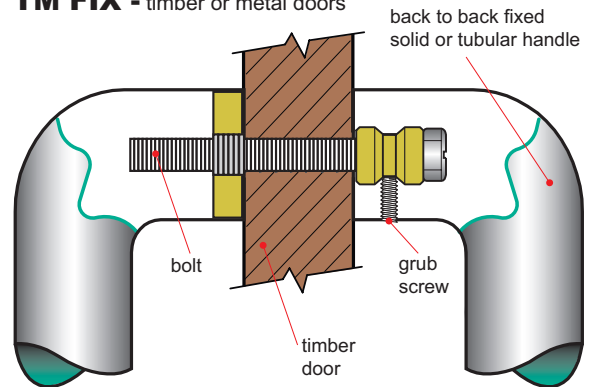

D FIX - glass, metal or timber doors

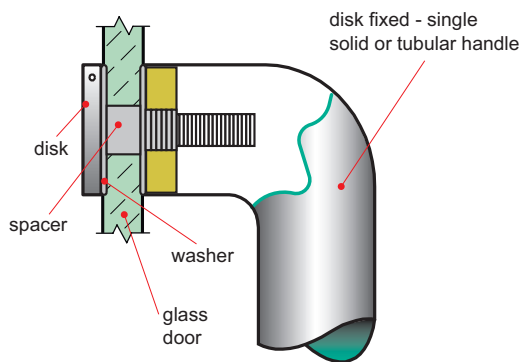

C FIX - timber doors only

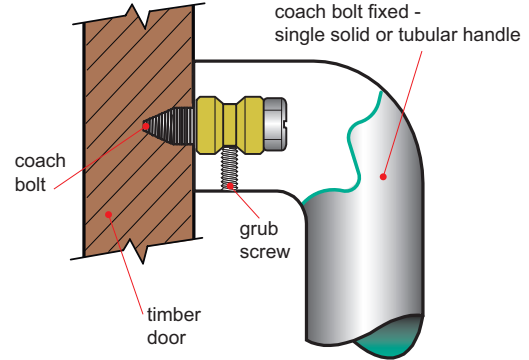

Nylon spacers and washers are included with handle for glass door fixing option

Drilling Details

Timber Door Fixings

| Material Size | Bolt Size |
|---------------|-----------|
| 32mm Ø | 8mm |
| 25mm Ø | 8mm |
| 19mm Ø | 8mm |
| 16mm Ø | 5mm |
| 14mm Ø | 5mm |

Metal Door Fixings

| Material Size | Bolt Size |
|---------------|-----------|
| 32mm Ø | 8mm |
| 25mm Ø | 8mm |
| 19mm Ø | 8mm |
| 16mm Ø | 5mm |
| 14mm Ø | 5mm |

Glass Door Fixings

| Material Size | Hole Size |
|---------------|-----------|
| 32mm Ø | 12mm Ø |
| 25mm Ø | 12mm Ø |
| 19mm Ø | 12mm Ø |
| 16mm Ø | 12mm Ø |
| 14mm Ø | 12mm Ø |

Handling Details

Door Opening In

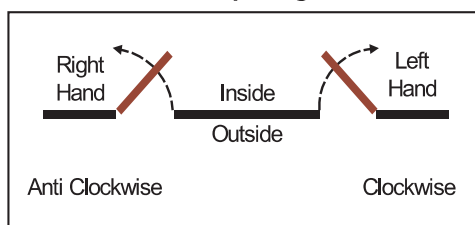

Door Opening Out

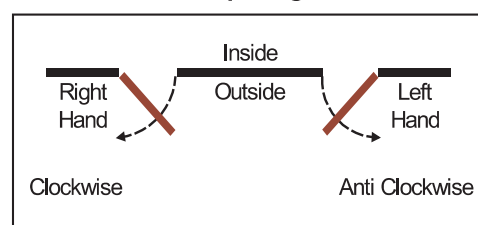

ENTRANCE HANDLES CATEGORY STYLES

| Straight Round Stainless Steel | Page # | Offset Round Stainless Steel | Page # |
|---------------------------------|--------|-------------------------------|--------|
| MDZ B1000 | 8 | MDZ 5250 | 15 |
| MDZ 2019 | 9 | MDZ 5450 | 17 |
| MDZ 5200 | 14 | MDZ 6250 | 19 |
| MDZ 5400 | 16 | MDZ 6450 | 22 |
| MDZ 6200 | 18 | MDZ 6500 | 23 |
| MDZ 6300 | 20 | MDZ 8090 | 34 |
| MDZ 6400 | 21 | MDZ 8120 | 37 |
| MDZ 8040 | 29 | MDZ 8160 | 42 |
| MDZ 8070 | 32 | MDZ 8190 | 45 |
| MDZ 8100 | 35 | MDZ 8220 | 48 |
| MDZ 8130 | 38 | MDZ 8260 | 52 |
| MDZ 8210 | 47 | MDZ 8390 | 61 |
| MDZ 8240 | 50 | MDZ 8400 | 62 |
| MDZ 8270 | 53 | | |
| MDZ 8340 | 56 | | |
| MDZ 8580 | 94 | | |
| MDZ 8590 | 95 | | |
| Straight Square Stainless Steel | Page # | Offset Square Stainless Steel | Page # |
| MDZ 2512 | 10 | MDZ 2512OF | 11 |
| MDZ 2525 | 12 | MDZ 2525OF | 13 |
| MDZ 8000 | 24 | MDZ 8020 | 27 |
| MDZ 8005 | 25 | MDZ 8050 | 30 |
| MDZ 8010 | 26 | MDZ 8080 | 33 |
| MDZ 8030 | 28 | MDZ 8110 | 36 |
| MDZ 8060 | 31 | MDZ 8140 | 39 |
| MDZ 8150 | 40 | MDZ 8155 | 41 |
| MDZ 8170 | 43 | MDZ 8200 | 46 |
| MDZ 8180 | 44 | MDZ 8350 | 57 |
| MDZ 8230 | 49 | MDZ 8360 | 58 |
| MDZ 8250 | 51 | MDZ 8370 | 59 |
| MDZ 8280 | 54 | | |
| MDZ 8330 | 55 | | |
| MDZ 8380 | 60 | | |
| MDZ 8410 | 63 | | |
| MDZ 8420 | 64 | | |
| MDZ 8430 | 65 | | |
| Straight Timber | Page # | Offset Timber | Page # |
| MDZ 8440 | 66 | MDZ 8480 | 74 |
| MDZ 8445 | 67 | MDZ 8485 | 75 |
| MDZ 8450 | 68 | MDZ 8500 | 78 |
| MDZ 8455 | 69 | MDZ 8505 | 79 |
| MDZ 8460 | 70 | MDZ 8520 | 82 |
| MDZ 8465 | 71 | MDZ 8525 | 83 |
| MDZ 8470 | 72 | MDZ 8570 | 92 |
| MDZ 8475 | 73 | MDZ 8575 | 93 |
| MDZ 8490 | 76 | | |
| MDZ 8495 | 77 | | |
| MDZ 8510 | 80 | | |
| MDZ 8515 | 81 | | |
| MDZ 8530 | 84 | | |
| MDZ 8535 | 85 | | |
| MDZ 8540 | 86 | | |
| MDZ 8545 | 87 | | |
| MDZ 8550 | 88 | | |
| MDZ 8555 | 89 | | |
| MDZ 8560 | 90 | | |
| MDZ 8565 | 91 | | |



NOTE:
AS1428 Compliant products
are indicated in **BOLD**

INTRODUCTION

Inspired by design, innovation and functionality, we are pleased to present our Entrance Handles catalogue.

Madinoz - as the name implies, is Made In OZ. It is our ability to work closely with architects, designers and developers which has allowed us to evolve with the market.

We are manufacturers of an ever expanding comprehensive range of architectural door hardware and use only quality materials such as solid brass and 316 marine-grade stainless steel to ensure lifelong usage.

Architects and designers may now be confident in selecting a quality well priced range with a distinctive design theme that will 'speak' throughout the whole project.

Madinoz combines handcrafted tradition with modern technology, to provide a well-priced product range which is refined to the smallest detail.

Please feel free to contact Madinoz should you have any special requirements or if you would like one of our Architectural Consultants to call on you.

We look forward to helping you and thank you for your interest and support.

Madinoz

Unit 3 / 1-7 Ada Avenue, Brookvale NSW 2100 Australia

Telephone: **(02) 9939 2007**

Facsimile: (02) 9939 8432

E-mail: sales@madinoz.com.au

Website: www.madinoz.com.au

GENERAL INFORMATION

Finishes:

SSS - Satin Stainless Steel

PSS - Polished Stainless Steel

Guarantee:

Madinoz unconditionally guarantee their products against defects in workmanship and materials, subject to fair wear and tear within the normal working life of the product. Madinoz assumes no liability for:

1. Improper installation or failure to follow fitting instructions.
2. Failure to improper maintenance.
3. Indirect or inconsequential loss or damage.
4. Cost of removal and/or replacement.
5. Cost of freight and/or travelling.

Design Registration:

Some of the products depicted in this catalogue are the subject of design registration.

Cleaning:

Madinoz products should be cleaned at regulars intervals with a soft 'grit-free' cloth, clean soapy water and wiped dry.

Warning:

Do not use a scouring pad of any type as this will cause excessive wear on the plated finish.

MADINOZ PRODUCT RECYCLING STEWARDSHIP POLICY

“With greater concerns about sustainability, designers are looking for low environmental impact solutions but do not want to compromise on aesthetics; Madinoz offers both.”

Guy Frangi, Manager
Madinoz Architectural Door Hardware
Australia

Madinoz Architectural Door Hardware, the highly regarded Australian manufacturer of stylish and premium quality door hardware, is very pleased to comply with **The Good Environmental Choice Australia Label (GECA)** which indicates the environmental performance of a product from multi-criteria and a whole of the product life perspective. Products certified by GECA provide Green Star accredited professionals with the right resources for their Green Star projects.



To move towards sustainable consumption buyers need to recognise which products and services have preferable environmental outcomes.

Madinoz is committed to undertaking a **Product Recycling Stewardship Program**, under which all brass and stainless steel components manufactured by Madinoz can be returned through the selected distributor for recycling at the end of product life. Madinoz ensures that all brass or stainless steel hardware, fittings, handles and accessories returned at product end of life will be recycled through relevant resource recovery networks and will not end up in Landfill*.

No other costs are chargeable to the consumer apart from transport cost to the Madinoz facility at Unit 3/1-7 Ada Avenue, Brookvale NSW 2100.

Please contact your distributor of Madinoz products to arrange return of goods. A tax receipt or some other documentary evidence from the original purchase must be retained in order to facilitate resource recovery.

WHY IS RECYCLING AND REDUCING THE IMPACT OF LANDFILL WASTE ON OUR ENVIRONMENT IMPORTANT?

The impacts of Landfill waste are a contributor to climate change.

The International Panel for Climate Change (IPCC) Fourth Assessment Report (2007) established that is highly confident that anthropogenic impacts such as the burning of fossil fuels and a 'disposable lifestyle culture' are the reasons for climate change.

Australia disposes of 32 million tonnes of solid waste into Landfill every year. 40% of this is attributable to the Construction and Demolition sector (Australian Bureau of Statistics, 2002-03).

Results from a Department of Environmental and Climate Change (DECC) study in 2004-05 showed that there are opportunities for up to 40% of the Construction & Demolition waste disposed to Landfill in the Sydney Metropolitan Area. The study estimated 30,000 tonnes of this was ferrous metals.

In recognising the critical role that the building industry plays in climate change in creating it and solving it, attaining the Good Environmental Choice Australia label and providing a Product Recycling Stewardship Policy is our way of moving towards sustainable consumption and being part of the solution.

For further information please contact Madinoz.

Unit 3 / 1-7 Ada Avenue, Brookvale NSW 2100 Australia

Telephone: **(02) 9939 2007**

Facsimile: (02) 9939 8432

E-mail: sales@madinoz.com.au

Website: www.madinoz.com.au

Entry Door Pull Handle - Lockable

Material 316 Marine Grade Stainless Steel

| Product No. | Diameter mm | Length mm | Fixing Centres mm |
|------------------------|-------------|-----------|-------------------|
| Single Cylinder | | | |
| MDZ B1000 | 35 | 1500 | 1125 |

NOTE:
External cylinder
Internal turn
Cylinder is 6 pin master keyable



HOW TO SPECIFY

Product No. / Diameter / Length / Finish / Door Type (refer diagram below)

eg: B1000 / 35 / 1500 / SSS / GD

B = BACK TO BACK FIX

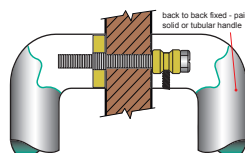

PLEASE SPECIFY DOOR TYPE

- GD** - Glass doors
- TM** - Timber doors
- AL** - Aluminium doors

Entry Door Pull Handle

Material 316 Marine Grade Stainless Steel



| Product No. | Diameter mm | Projection mm | Length mm |
|-------------------|-------------|---------------|-----------|
| MDZ 2019/K | 19 | 69 | 1400 |
| MDZ 2019/L | 19 | 69 | 1300 |
| MDZ 2019/M | 19 | 69 | 1200 |
| MDZ 2019/N | 19 | 69 | 1100 |
| MDZ 2019/O | 19 | 69 | 1000 |
| MDZ 2019/P | 19 | 69 | 900 |
| MDZ 2019/Q | 19 | 69 | 800 |
| MDZ 2019/R | 19 | 69 | 700 |
| MDZ 2019/S | 19 | 69 | 600 |
| MDZ 2019/T | 19 | 69 | 500 |
| MDZ 2019/U | 19 | 69 | 400 |

HOW TO SPECIFY

Product No. / Diameter / Projector / Finish / Fixing (refer diagram below)

eg: 2019K / 19 / 69 / SSS / D Fix GD

B = BACK TO BACK FIX

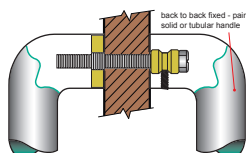

D = DISK FIX

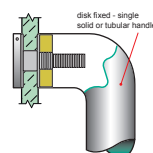

C = CONCEALED FIX

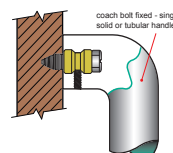

PLEASE SPECIFY DOOR TYPE

GD - Glass doors

TM - Timber doors

AL - Aluminium doors

Entry Door Pull Handle

Material 316 Marine Grade Stainless Steel

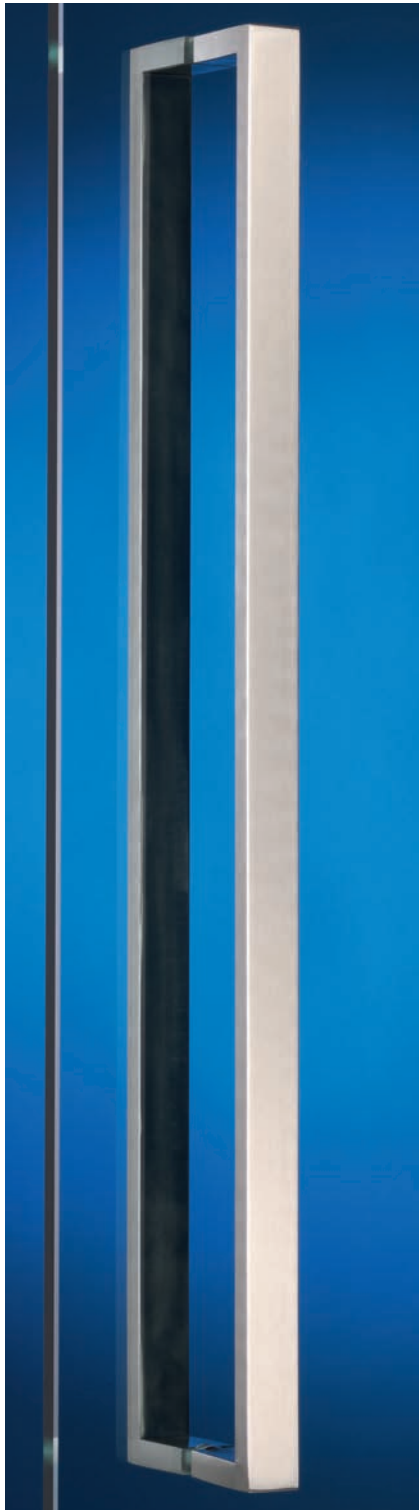

| Product No. | Fixing Centres mm | Rail Section mm | Standoff mm | Unit | Projection mm | Overall Length mm |
|-------------|-------------------|-----------------|-------------|------|---------------|-------------------|
|-------------|-------------------|-----------------|-------------|------|---------------|-------------------|

Back to Back Fix

| | | | | | | |
|------------------|-----|-------|-------|------|----|-----|
| MDZ B2512 | 600 | 12x25 | 25x12 | Pair | 50 | 612 |
| MDZ B2512 | 450 | 12x25 | 25x12 | Pair | 50 | 462 |
| MDZ B2512 | 300 | 12x25 | 25x12 | Pair | 50 | 312 |
| MDZ B2512 | 200 | 12x25 | 25x12 | Pair | 50 | 212 |

Disk Fix

| | | | | | | |
|------------------|-----|-------|-------|--------|----|-----|
| MDZ D2512 | 600 | 12x25 | 25x12 | Single | 50 | 612 |
| MDZ D2512 | 450 | 12x25 | 25x12 | Single | 50 | 462 |
| MDZ D2512 | 300 | 12x25 | 25x12 | Single | 50 | 312 |
| MDZ D2512 | 200 | 12x25 | 25x12 | Single | 50 | 212 |

Concealed Fix

| | | | | | | |
|------------------|-----|-------|-------|--------|----|-----|
| MDZ C2512 | 600 | 12x25 | 25x12 | Single | 50 | 612 |
| MDZ C2512 | 450 | 12x25 | 25x12 | Single | 50 | 462 |
| MDZ C2512 | 300 | 12x25 | 25x12 | Single | 50 | 312 |
| MDZ C2512 | 200 | 12x25 | 25x12 | Single | 50 | 212 |

NOTE:
Special sizes available on request



HOW TO SPECIFY

Product No. / Fixing Centres / Rail Section / Finish / Fixing (refer diagram below)

eg: B2512 / 600 / 12x25 / SSS / TM

B = BACK TO BACK FIX

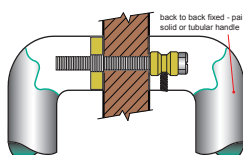

D = DISK FIX

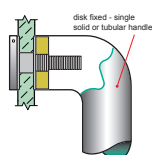

C = CONCEALED FIX

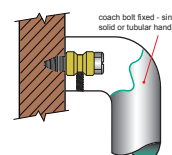

PLEASE SPECIFY DOOR TYPE

GD - Glass doors

TM - Timber doors

AL - Aluminium doors

Entry Door Pull Handle

Material 316 Marine Grade Stainless Steel

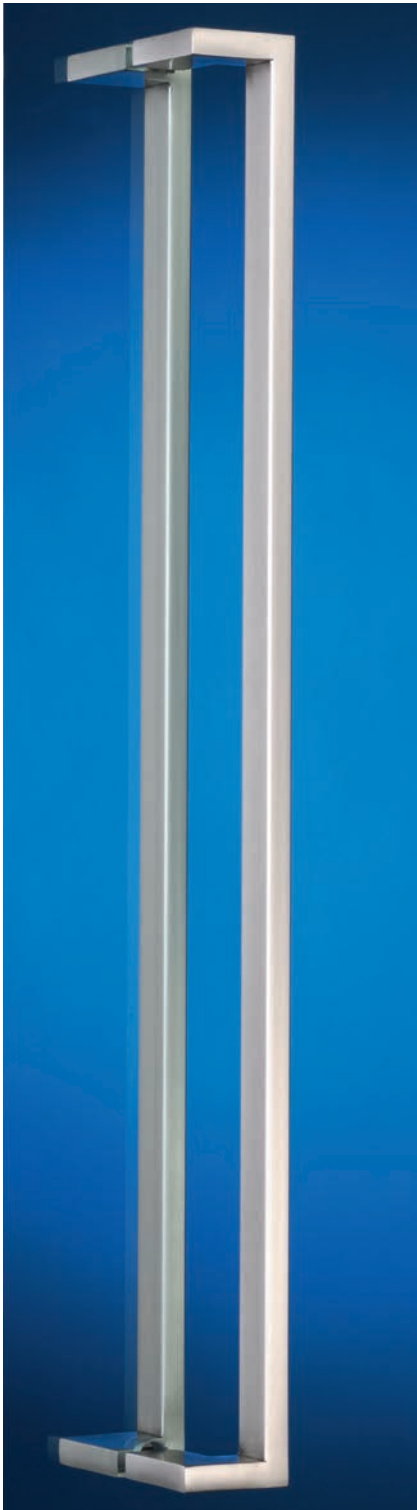

| Product No. | Fixing Centres mm | Rail Section mm | Standoff mm | Unit | Projection mm | Offset mm |
|-------------|-------------------|-----------------|-------------|------|---------------|-----------|
|-------------|-------------------|-----------------|-------------|------|---------------|-----------|

Back to Back Fix

| | | | | | | |
|-------------|-----|-------|-------|------|----|----|
| MDZ B2512OF | 600 | 12x25 | 25x12 | Pair | 60 | 50 |
| MDZ B2512OF | 450 | 12x25 | 25x12 | Pair | 60 | 50 |
| MDZ B2512OF | 300 | 12x25 | 25x12 | Pair | 60 | 50 |
| MDZ B2512OF | 200 | 12x25 | 25x12 | Pair | 60 | 50 |

Disk Fix

| | | | | | | |
|-------------|-----|-------|-------|--------|----|----|
| MDZ D2512OF | 600 | 12x25 | 25x12 | Single | 60 | 50 |
| MDZ D2512OF | 450 | 12x25 | 25x12 | Single | 60 | 50 |
| MDZ D2512OF | 300 | 12x25 | 25x12 | Single | 60 | 50 |
| MDZ D2512OF | 200 | 12x25 | 25x12 | Single | 60 | 50 |

Concealed Fix

| | | | | | | |
|-------------|-----|-------|-------|--------|----|----|
| MDZ C2512OF | 600 | 12x25 | 25x12 | Single | 60 | 50 |
| MDZ C2512OF | 450 | 12x25 | 25x12 | Single | 60 | 50 |
| MDZ C2512OF | 300 | 12x25 | 25x12 | Single | 60 | 50 |
| MDZ C2512OF | 200 | 12x25 | 25x12 | Single | 60 | 50 |

NOTE:
Special sizes available on request



HOW TO SPECIFY

Product No. / Fixing Centres / Rail Section / Finish / Fixing (refer diagram below)

eg: B2512OF / 600 / 12x25 / SSS / TM

B = BACK TO BACK FIX

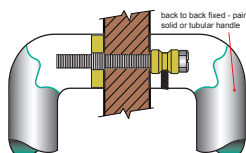

back to back fixed - pair solid or tubular handle

D = DISK FIX

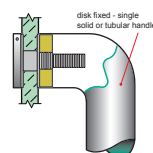

disk fixed - single solid or tubular handle

C = CONCEALED FIX

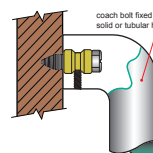

coach bolt fixed - single solid or tubular handle

PLEASE SPECIFY DOOR TYPE

GD - Glass doors

TM - Timber doors

AL - Aluminium doors

Entry Door Pull Handle

Material 316 Marine Grade Stainless Steel

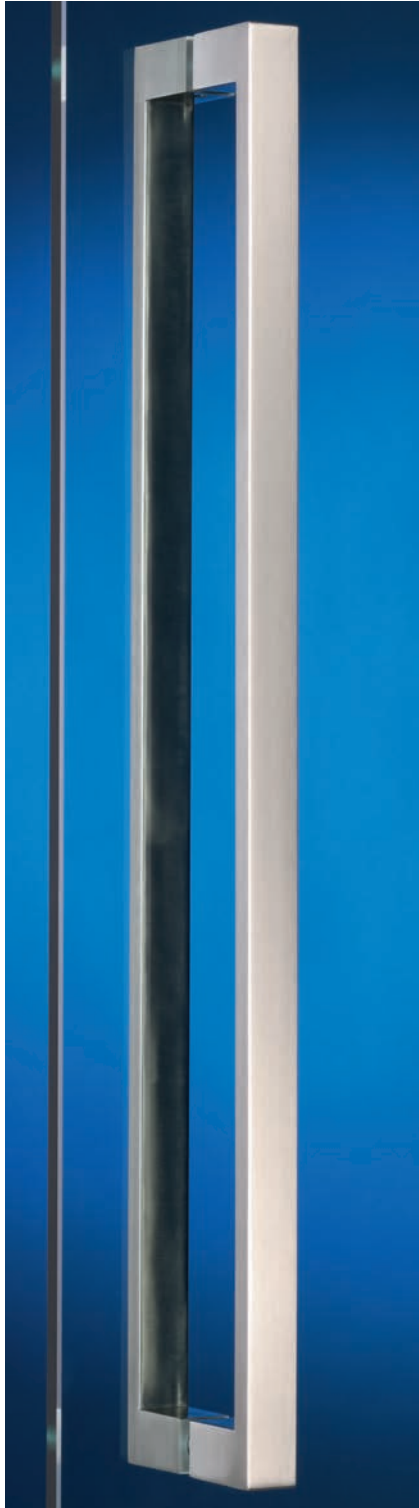

| Product No. | Fixing Centres mm | Rail Section mm | Standoff mm | Unit | Projection mm | Overall Length mm |
|-------------|-------------------|-----------------|-------------|------|---------------|-------------------|
|-------------|-------------------|-----------------|-------------|------|---------------|-------------------|

Back to Back Fix

| | | | | | | |
|------------------|-----|-------|-------|------|----|-----|
| MDZ B2525 | 600 | 10x25 | 25x25 | Pair | 50 | 625 |
| MDZ B2525 | 450 | 10x25 | 25x25 | Pair | 50 | 475 |
| MDZ B2525 | 300 | 10x25 | 25x25 | Pair | 50 | 325 |
| MDZ B2525 | 200 | 10x25 | 25x25 | Pair | 50 | 225 |

Disk Fix

| | | | | | | |
|------------------|-----|-------|-------|--------|----|-----|
| MDZ D2525 | 600 | 10x25 | 25x25 | Single | 50 | 625 |
| MDZ D2525 | 450 | 10x25 | 25x25 | Single | 50 | 475 |
| MDZ D2525 | 300 | 10x25 | 25x25 | Single | 50 | 325 |
| MDZ D2525 | 200 | 10x25 | 25x25 | Single | 50 | 225 |

Concealed Fix

| | | | | | | |
|------------------|-----|-------|-------|--------|----|-----|
| MDZ C2525 | 600 | 10x25 | 25x25 | Single | 50 | 625 |
| MDZ C2525 | 450 | 10x25 | 25x25 | Single | 50 | 475 |
| MDZ C2525 | 300 | 10x25 | 25x25 | Single | 50 | 325 |
| MDZ C2525 | 200 | 10x25 | 25x25 | Single | 50 | 225 |

NOTE:
Special sizes available on request



HOW TO SPECIFY

Product No. / Fixing Centres / Rail Section / Finish / Fixing (refer diagram below)

eg: B2525 / 600 / 10x25 / SSS / TM

B = BACK TO BACK FIX

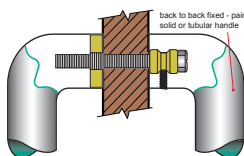

back to back fixed - pair
solid or tubular handle

D = DISK FIX

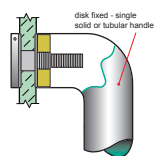

disk fixed - single
solid or tubular handle

C = CONCEALED FIX

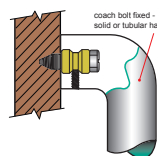

conceal bolt fixed - single
solid or tubular handle

PLEASE SPECIFY DOOR TYPE

GD - Glass doors

TM - Timber doors

AL - Aluminium doors

Entry Door Pull Handle

Material 316 Marine Grade Stainless Steel

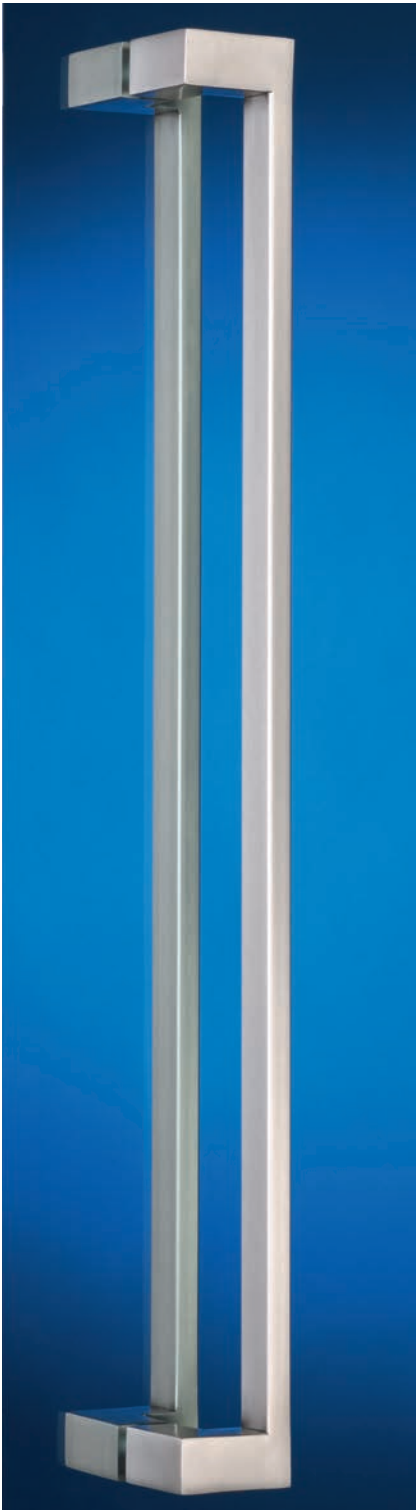

| Product No. | Fixing Centres mm | Rail Section mm | Standoff mm | Unit | Projection mm | Offset mm |
|-------------|-------------------|-----------------|-------------|------|---------------|-----------|
|-------------|-------------------|-----------------|-------------|------|---------------|-----------|

Back to Back Fix

| | | | | | | |
|-------------|-----|-------|-------|------|----|----|
| MDZ B2525OF | 600 | 25x12 | 25x25 | Pair | 60 | 50 |
| MDZ B2525OF | 450 | 25x12 | 25x25 | Pair | 60 | 50 |
| MDZ B2525OF | 300 | 25x12 | 25x25 | Pair | 60 | 50 |
| MDZ B2525OF | 200 | 25x12 | 25x25 | Pair | 60 | 50 |

Disk Fix

| | | | | | | |
|-------------|-----|-------|-------|--------|----|----|
| MDZ D2525OF | 600 | 25x12 | 25x25 | Single | 60 | 50 |
| MDZ D2525OF | 450 | 25x12 | 25x25 | Single | 60 | 50 |
| MDZ D2525OF | 300 | 25x12 | 25x25 | Single | 60 | 50 |
| MDZ D2525OF | 200 | 25x12 | 25x25 | Single | 60 | 50 |

Concealed Fix

| | | | | | | |
|-------------|-----|-------|-------|--------|----|----|
| MDZ C2525OF | 600 | 25x12 | 25x25 | Single | 60 | 50 |
| MDZ C2525OF | 450 | 25x12 | 25x25 | Single | 60 | 50 |
| MDZ C2525OF | 300 | 25x12 | 25x25 | Single | 60 | 50 |
| MDZ C2525OF | 200 | 25x12 | 25x25 | Single | 60 | 50 |

NOTE:
Special sizes available on request



HOW TO SPECIFY

Product No. / Fixing Centres / Rail Section / Finish / Fixing (refer diagram below)

eg: B2525OF / 600 / 25x12 / SSS / TM

B = BACK TO BACK FIX

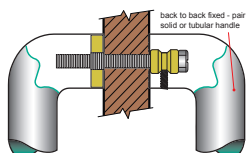

back to back fixed - pair solid or tubular handle

D = DISK FIX

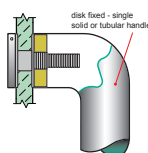

disk fixed - single solid or tubular handle

C = CONCEALED FIX

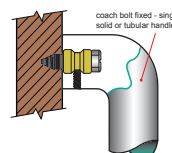

coach bolt fixed - single solid or tubular handle

PLEASE SPECIFY DOOR TYPE

GD - Glass doors

TM - Timber doors

AL - Aluminium doors

Entry Door Pull Handle

Material 316 Marine Grade Stainless Steel



| Product No. | Diameter mm | | Length mm | Fixing Centres mm |
|-------------------|-------------|----|-----------|-------------------|
| MDZ 5200/K | 16 | 14 | 1400 | 1240 |
| MDZ 5200/L | 16 | 14 | 1300 | 1140 |
| MDZ 5200/M | 16 | 14 | 1200 | 1040 |
| MDZ 5200/N | 16 | 14 | 1100 | 940 |
| MDZ 5200/O | 16 | 14 | 1000 | 840 |
| MDZ 5200/P | 16 | 14 | 900 | 740 |
| MDZ 5200/Q | 16 | 14 | 800 | 640 |
| MDZ 5200/R | 16 | 14 | 700 | 540 |
| MDZ 5200/S | 16 | 14 | 600 | 440 |
| MDZ 5200/T | 16 | 14 | 500 | 340 |
| MDZ 5200/U | 16 | 14 | 400 | 240 |

NOTE:
Special sizes available on request

HOW TO SPECIFY

Product No. / Diameter / Length / Finish / Fixing (refer diagram below)

eg: 5200K / 16 / 1400 / SSS / D Fix GD

B = BACK TO BACK FIX

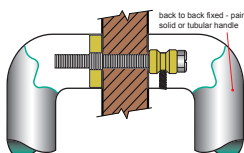

D = DISK FIX

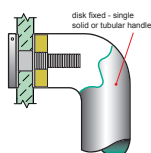

C = CONCEALED FIX

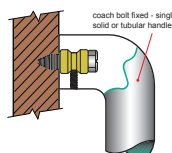

PLEASE SPECIFY DOOR TYPE

GD - Glass doors

TM - Timber doors

AL - Aluminium doors

Entry Door Pull Handle

Material 316 Marine Grade Stainless Steel



| Product No. | Diameter mm | | Projection mm | | Offset mm | | Length mm | Fixing Centres mm |
|-------------------|-------------|----|---------------|----|-----------|----|-----------|-------------------|
| MDZ 5250/K | 16 | 14 | 50 | 48 | 85 | 80 | 1400 | 1240 |
| MDZ 5250/L | 16 | 14 | 50 | 48 | 85 | 80 | 1300 | 1140 |
| MDZ 5250/M | 16 | 14 | 50 | 48 | 85 | 80 | 1200 | 1040 |
| MDZ 5250/N | 16 | 14 | 50 | 48 | 85 | 80 | 1100 | 940 |
| MDZ 5250/O | 16 | 14 | 50 | 48 | 85 | 80 | 1000 | 840 |
| MDZ 5250/P | 16 | 14 | 50 | 48 | 85 | 80 | 900 | 740 |
| MDZ 5250/Q | 16 | 14 | 50 | 48 | 85 | 80 | 800 | 640 |
| MDZ 5250/R | 16 | 14 | 50 | 48 | 85 | 80 | 700 | 540 |
| MDZ 5250/S | 16 | 14 | 50 | 48 | 85 | 80 | 600 | 440 |
| MDZ 5250/T | 16 | 14 | 50 | 48 | 85 | 80 | 500 | 340 |
| MDZ 5250/U | 16 | 14 | 50 | 48 | 85 | 80 | 400 | 240 |

NOTE:
Special sizes available on request

HOW TO SPECIFY

Product No. / Diameter / Projection / Finish / Fixing (refer diagram below)

eg: 5250K / 16 / 50 / SSS / D Fix GD

B = BACK TO BACK FIX

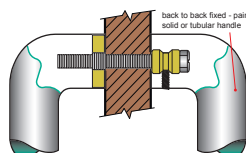

D = DISK FIX

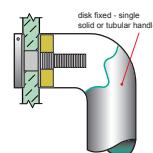

C = CONCEALED FIX

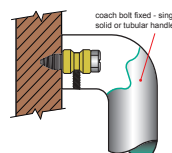

PLEASE SPECIFY DOOR TYPE

GD - Glass doors

TM - Timber doors

AL - Aluminium doors

Entry Door Pull Handle

Material 316 Marine Grade Stainless Steel



| Product No. | Diameter mm | | Length mm | Fixing Centres mm |
|-------------------|-------------|----|-----------|-------------------|
| MDZ 5400/K | 16 | 14 | 1400 | 1240 |
| MDZ 5400/L | 16 | 14 | 1300 | 1140 |
| MDZ 5400/M | 16 | 14 | 1200 | 1040 |
| MDZ 5400/N | 16 | 14 | 1100 | 940 |
| MDZ 5400/O | 16 | 14 | 1000 | 840 |
| MDZ 5400/P | 16 | 14 | 900 | 740 |
| MDZ 5400/Q | 16 | 14 | 800 | 640 |
| MDZ 5400/R | 16 | 14 | 700 | 540 |
| MDZ 5400/S | 16 | 14 | 600 | 440 |
| MDZ 5400/T | 16 | 14 | 500 | 340 |
| MDZ 5400/U | 16 | 14 | 400 | 240 |

NOTE:
Special sizes available on request

HOW TO SPECIFY

Product No. / Diameter / Length / Finish / Fixing (refer diagram below)

eg: 5400K / 16 / 1400 / SSS / D Fix GD

B = BACK TO BACK FIX

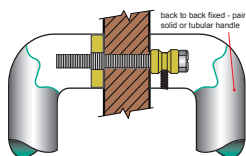

D = DISK FIX

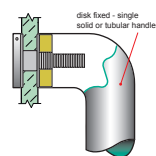

C = CONCEALED FIX

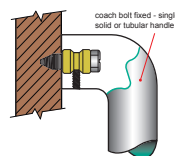

PLEASE SPECIFY DOOR TYPE

GD - Glass doors

TM - Timber doors

AL - Aluminium doors

Entry Door Pull Handle

Material 316 Marine Grade Stainless Steel



| Product No. | Diameter mm | | Projection mm | | Offset mm | | Length mm | Fixing Centres mm |
|-------------------|-------------|----|---------------|----|-----------|----|-----------|-------------------|
| | 16 | 14 | 50 | 48 | 80 | 75 | | |
| MDZ 5450/K | 16 | 14 | 50 | 48 | 80 | 75 | 1400 | 1240 |
| MDZ 5450/L | 16 | 14 | 50 | 48 | 80 | 75 | 1300 | 1140 |
| MDZ 5450/M | 16 | 14 | 50 | 48 | 80 | 75 | 1200 | 1040 |
| MDZ 5450/N | 16 | 14 | 50 | 48 | 80 | 75 | 1100 | 940 |
| MDZ 5450/O | 16 | 14 | 50 | 48 | 80 | 75 | 1000 | 840 |
| MDZ 5450/P | 16 | 14 | 50 | 48 | 80 | 75 | 900 | 740 |
| MDZ 5450/Q | 16 | 14 | 50 | 48 | 80 | 75 | 800 | 640 |
| MDZ 5450/R | 16 | 14 | 50 | 48 | 80 | 75 | 700 | 540 |
| MDZ 5450/S | 16 | 14 | 50 | 48 | 80 | 75 | 600 | 440 |
| MDZ 5450/T | 16 | 14 | 50 | 48 | 80 | 75 | 500 | 340 |
| MDZ 5450/U | 16 | 14 | 50 | 48 | 80 | 75 | 400 | 240 |

NOTE:
Special sizes available on request

HOW TO SPECIFY

Product No. / Diameter / Projection / Finish / Fixing (refer diagram below)

eg: 5450K / 16 / 50 / SSS / D Fix GD

B = BACK TO BACK FIX

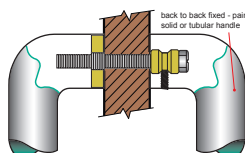

D = DISK FIX

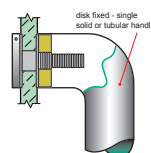

C = CONCEALED FIX

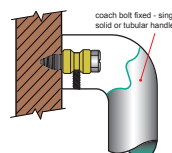

PLEASE SPECIFY DOOR TYPE

GD - Glass doors

TM - Timber doors

AL - Aluminium doors

Entry Door Pull Handle

Material 316 Marine Grade Stainless Steel



| Product No. | Diameter mm | | | Length mm | Fixing Centres mm |
|-------------|-------------|----|----|-----------|-------------------|
| MDZ 6200/A | 32 | 25 | 19 | 2400 | 2240 |
| MDZ 6200/B | 32 | 25 | 19 | 2300 | 2140 |
| MDZ 6200/C | 32 | 25 | 19 | 2200 | 2040 |
| MDZ 6200/D | 32 | 25 | 19 | 2100 | 1940 |
| MDZ 6200/E | 32 | 25 | 19 | 2000 | 1840 |
| MDZ 6200/F | 32 | 25 | 19 | 1900 | 1740 |
| MDZ 6200/G | 32 | 25 | 19 | 1800 | 1640 |
| MDZ 6200/H | 32 | 25 | 19 | 1700 | 1540 |
| MDZ 6200/I | 32 | 25 | 19 | 1600 | 1440 |
| MDZ 6200/J | 32 | 25 | 19 | 1500 | 1340 |
| MDZ 6200/K | 32 | 25 | 19 | 1400 | 1240 |
| MDZ 6200/L | 32 | 25 | 19 | 1300 | 1140 |
| MDZ 6200/M | 32 | 25 | 19 | 1200 | 1040 |
| MDZ 6200/N | 32 | 25 | 19 | 1100 | 940 |
| MDZ 6200/O | 32 | 25 | 19 | 1000 | 840 |
| MDZ 6200/P | 32 | 25 | 19 | 900 | 740 |
| MDZ 6200/Q | 32 | 25 | 19 | 800 | 640 |
| MDZ 6200/R | 32 | 25 | 19 | 700 | 540 |
| MDZ 6200/S | 32 | 25 | 19 | 600 | 440 |
| MDZ 6200/T | 32 | 25 | 19 | 500 | 340 |
| MDZ 6200/U | 32 | 25 | 19 | 400 | 240 |

NOTE:
Special sizes available on request



HOW TO SPECIFY

Product No. / Diameter / Length / Finish / Fixing (refer diagram below)

eg: 6200A / 32 / 2400 / SSS / D Fix GD

B = BACK TO BACK FIX

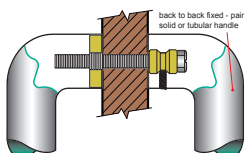

D = DISK FIX

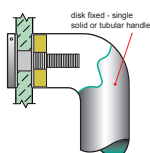

C = CONCEALED FIX

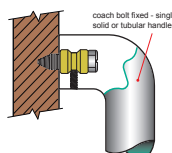

PLEASE SPECIFY DOOR TYPE

- GD** - Glass doors
- TM** - Timber doors
- AL** - Aluminium doors

Entry Door Pull Handle

Material 316 Marine Grade Stainless Steel



| Product No. | Diameter mm | Projection mm | Offset mm | Length mm | Fixing Centres mm |
|-------------------|-------------|---------------|-----------|-----------|-------------------|
| MDZ 6250/G | 19 | 65 | 90 | 1800 | 1640 |
| MDZ 6250/H | 19 | 65 | 90 | 1700 | 1540 |
| MDZ 6250/I | 19 | 65 | 90 | 1600 | 1440 |
| MDZ 6250/J | 19 | 65 | 90 | 1500 | 1340 |
| MDZ 6250/K | 19 | 65 | 90 | 1400 | 1240 |
| MDZ 6250/L | 19 | 65 | 90 | 1300 | 1140 |
| MDZ 6250/M | 19 | 65 | 90 | 1200 | 1040 |
| MDZ 6250/N | 19 | 65 | 90 | 1100 | 940 |
| MDZ 6250/O | 19 | 65 | 90 | 1000 | 840 |
| MDZ 6250/P | 19 | 65 | 90 | 900 | 740 |
| MDZ 6250/Q | 19 | 65 | 90 | 800 | 640 |
| MDZ 6250/R | 19 | 65 | 90 | 700 | 540 |
| MDZ 6250/S | 19 | 65 | 90 | 600 | 440 |
| MDZ 6250/T | 19 | 65 | 90 | 500 | 340 |
| MDZ 6250/U | 19 | 65 | 90 | 400 | 240 |

NOTE:
Special sizes available on request

HOW TO SPECIFY

Product No. / Diameter / Projection / Finish / Fixing (refer diagram below)

eg: 6250G / 19 / 65 / SSS / D Fix GD

B = BACK TO BACK FIX

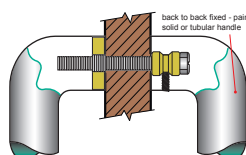

D = DISK FIX

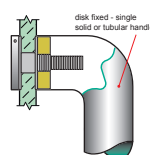

C = CONCEALED FIX

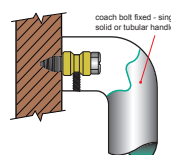

PLEASE SPECIFY DOOR TYPE

GD - Glass doors

TM - Timber doors

AL - Aluminium doors

Entry Door Pull Handle

Material 316 Marine Grade Stainless Steel

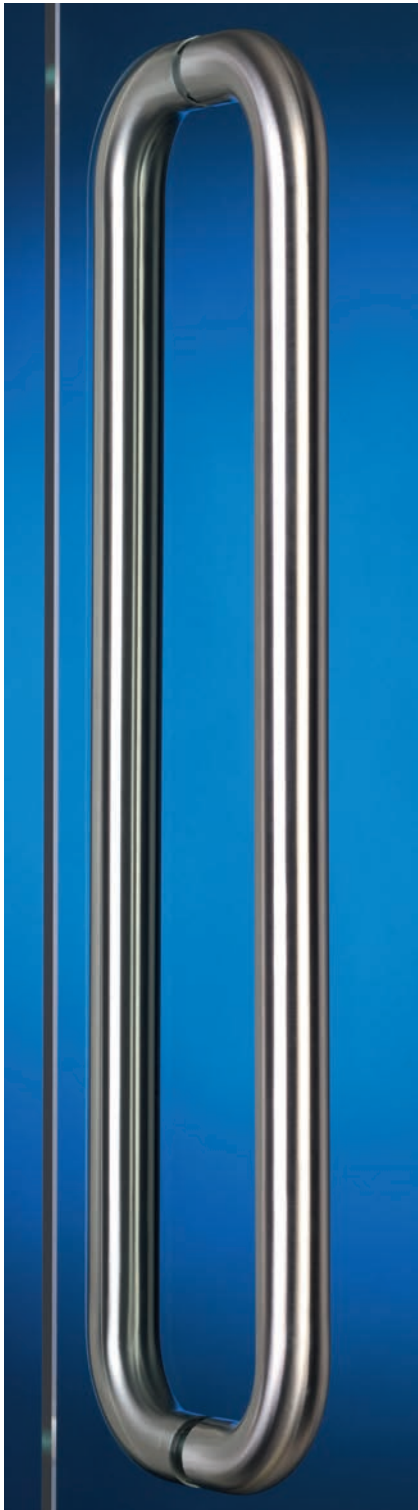

| Product No. | Diameter mm | | Projection mm | | Fixing Centres mm |
|-------------------|-------------|----|---------------|----|-------------------|
| MDZ 6300/K | 32 | 25 | 85 | 75 | 1400 |
| MDZ 6300/L | 32 | 25 | 85 | 75 | 1300 |
| MDZ 6300/M | 32 | 25 | 85 | 75 | 1200 |
| MDZ 6300/N | 32 | 25 | 85 | 75 | 1100 |
| MDZ 6300/O | 32 | 25 | 85 | 75 | 1000 |
| MDZ 6300/P | 32 | 25 | 85 | 75 | 900 |
| MDZ 6300/Q | 32 | 25 | 85 | 75 | 800 |
| MDZ 6300/R | 32 | 25 | 85 | 75 | 700 |
| MDZ 6300/S | 32 | 25 | 85 | 75 | 600 |
| MDZ 6300/T | 32 | 25 | 85 | 75 | 500 |
| MDZ 6300/U | 32 | 25 | 85 | 75 | 400 |
| MDZ 6300/V | 32 | 25 | 85 | 75 | 300 |
| MDZ 6300/W | 32 | 25 | 85 | 75 | 250 |
| MDZ 6300/X | 32 | 25 | 85 | 75 | 200 |

NOTE:
Special sizes available on request

HOW TO SPECIFY

Product No. / Diameter / Projection / Finish / Fixing (refer diagram below)

eg: 6300K / 32 / 85 / SSS / D Fix GD

B = BACK TO BACK FIX

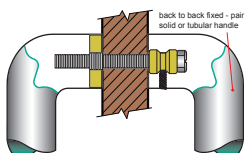

D = DISK FIX

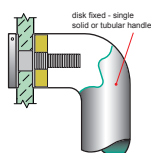

C = CONCEALED FIX

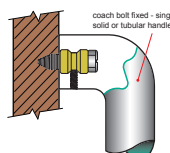

PLEASE SPECIFY DOOR TYPE

GD - Glass doors

TM - Timber doors

AL - Aluminium doors

Entry Door Pull Handle

Material 316 Marine Grade Stainless Steel



| Product No. | Diameter mm | | | Projection mm | | | Length mm | Fixing Centres mm |
|-------------|-------------|----|----|---------------|----|----|-----------|-------------------|
| MDZ 6400/A | 32 | 25 | 19 | 77 | 70 | 64 | 2400 | 2240 |
| MDZ 6400/B | 32 | 25 | 19 | 77 | 70 | 64 | 2300 | 2140 |
| MDZ 6400/C | 32 | 25 | 19 | 77 | 70 | 64 | 2200 | 2040 |
| MDZ 6400/D | 32 | 25 | 19 | 77 | 70 | 64 | 2100 | 1940 |
| MDZ 6400/E | 32 | 25 | 19 | 77 | 70 | 64 | 2000 | 1840 |
| MDZ 6400/F | 32 | 25 | 19 | 77 | 70 | 64 | 1900 | 1740 |
| MDZ 6400/G | 32 | 25 | 19 | 77 | 70 | 64 | 1800 | 1640 |
| MDZ 6400/H | 32 | 25 | 19 | 77 | 70 | 64 | 1700 | 1540 |
| MDZ 6400/I | 32 | 25 | 19 | 77 | 70 | 64 | 1600 | 1440 |
| MDZ 6400/J | 32 | 25 | 19 | 77 | 70 | 64 | 1500 | 1340 |
| MDZ 6400/K | 32 | 25 | 19 | 77 | 70 | 64 | 1400 | 1240 |
| MDZ 6400/L | 32 | 25 | 19 | 77 | 70 | 64 | 1300 | 1140 |
| MDZ 6400/M | 32 | 25 | 19 | 77 | 70 | 64 | 1200 | 1040 |
| MDZ 6400/N | 32 | 25 | 19 | 77 | 70 | 64 | 1100 | 940 |
| MDZ 6400/O | 32 | 25 | 19 | 77 | 70 | 64 | 1000 | 840 |
| MDZ 6400/P | 32 | 25 | 19 | 77 | 70 | 64 | 900 | 740 |
| MDZ 6400/Q | 32 | 25 | 19 | 77 | 70 | 64 | 800 | 640 |
| MDZ 6400/R | 32 | 25 | 19 | 77 | 70 | 64 | 700 | 540 |
| MDZ 6400/S | 32 | 25 | 19 | 77 | 70 | 64 | 600 | 440 |
| MDZ 6400/T | 32 | 25 | 19 | 77 | 70 | 64 | 500 | 340 |
| MDZ 6400/U | 32 | 25 | 19 | 77 | 70 | 64 | 400 | 240 |

NOTE:
Special sizes available on request



HOW TO SPECIFY

Product No. / Diameter / Projection / Finish / Fixing (refer diagram below)

eg: 6400A / 32 / 77 / SSS / D Fix GD

B = BACK TO BACK FIX

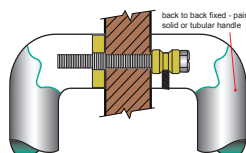

D = DISK FIX

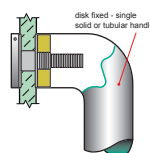

C = CONCEALED FIX

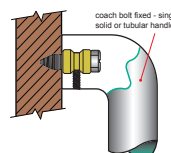

PLEASE SPECIFY DOOR TYPE

GD - Glass doors

TM - Timber doors

AL - Aluminium doors

Entry Door Pull Handle

Material 316 Marine Grade Stainless Steel



| Product No. | Diameter mm | Projection mm | Offset mm | Length mm | Fixing Centres mm |
|-------------|-------------|---------------|-----------|-----------|-------------------|
| MDZ 6450/G | 19 | 65 | 95 | 1800 | 1640 |
| MDZ 6450/H | 19 | 65 | 95 | 1700 | 1540 |
| MDZ 6450/I | 19 | 65 | 95 | 1600 | 1440 |
| MDZ 6450/J | 19 | 65 | 95 | 1500 | 1340 |
| MDZ 6450/K | 19 | 65 | 95 | 1400 | 1240 |
| MDZ 6450/L | 19 | 65 | 95 | 1300 | 1140 |
| MDZ 6450/M | 19 | 65 | 95 | 1200 | 1040 |
| MDZ 6450/N | 19 | 65 | 95 | 1100 | 940 |
| MDZ 6450/O | 19 | 65 | 95 | 1000 | 840 |
| MDZ 6450/P | 19 | 65 | 95 | 900 | 740 |
| MDZ 6450/Q | 19 | 65 | 95 | 800 | 640 |
| MDZ 6450/R | 19 | 65 | 95 | 700 | 540 |
| MDZ 6450/S | 19 | 65 | 95 | 600 | 440 |
| MDZ 6450/T | 19 | 65 | 95 | 500 | 340 |
| MDZ 6450/U | 19 | 65 | 95 | 400 | 240 |

NOTE:
Special sizes available on request

HOW TO SPECIFY

Product No. / Diameter / Projection / Finish / Fixing (refer diagram below)

eg: 6450G / 19 / 65 / SSS / D Fix GD

B = BACK TO BACK FIX

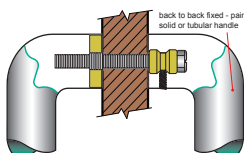

D = DISK FIX

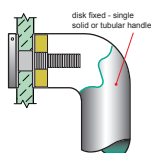

C = CONCEALED FIX

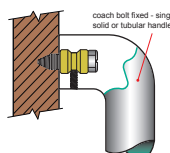

PLEASE SPECIFY DOOR TYPE

GD - Glass doors

TM - Timber doors

AL - Aluminium doors

Entry Door Pull Handle

Material 316 Marine Grade Stainless Steel



| Product No. | Diameter mm | | Projection mm | | Offset mm | | Length mm | Fixing Centres mm |
|-------------|-------------|----|---------------|----|-----------|----|-----------|-------------------|
| MDZ 6500/A | 32 | 25 | 83 | 70 | 90 | 85 | 2400 | 2240 |
| MDZ 6500/B | 32 | 25 | 83 | 70 | 90 | 85 | 2300 | 2140 |
| MDZ 6500/C | 32 | 25 | 83 | 70 | 90 | 85 | 2200 | 2040 |
| MDZ 6500/D | 32 | 25 | 83 | 70 | 90 | 85 | 2100 | 1940 |
| MDZ 6500/E | 32 | 25 | 83 | 70 | 90 | 85 | 2000 | 1840 |
| MDZ 6500/F | 32 | 25 | 83 | 70 | 90 | 85 | 1900 | 1740 |
| MDZ 6500/G | 32 | 25 | 83 | 70 | 90 | 85 | 1800 | 1640 |
| MDZ 6500/H | 32 | 25 | 83 | 70 | 90 | 85 | 1700 | 1540 |
| MDZ 6500/I | 32 | 25 | 83 | 70 | 90 | 85 | 1600 | 1440 |
| MDZ 6500/J | 32 | 25 | 83 | 70 | 90 | 85 | 1500 | 1340 |
| MDZ 6500/K | 32 | 25 | 83 | 70 | 90 | 85 | 1400 | 1240 |
| MDZ 6500/L | 32 | 25 | 83 | 70 | 90 | 85 | 1300 | 1140 |
| MDZ 6500/M | 32 | 25 | 83 | 70 | 90 | 85 | 1200 | 1040 |
| MDZ 6500/N | 32 | 25 | 83 | 70 | 90 | 85 | 1100 | 940 |
| MDZ 6500/O | 32 | 25 | 83 | 70 | 90 | 85 | 1000 | 840 |
| MDZ 6500/P | 32 | 25 | 83 | 70 | 90 | 85 | 900 | 740 |
| MDZ 6500/Q | 32 | 25 | 83 | 70 | 90 | 85 | 800 | 640 |
| MDZ 6500/R | 32 | 25 | 83 | 70 | 90 | 85 | 700 | 540 |
| MDZ 6500/S | 32 | 25 | 83 | 70 | 90 | 85 | 600 | 440 |
| MDZ 6500/T | 32 | 25 | 83 | 70 | 90 | 85 | 500 | 340 |
| MDZ 6500/U | 32 | 25 | 83 | 70 | 90 | 85 | 400 | 240 |

NOTE:

MDZ 6500/A to F to come with 3 stand offs (fixing points) in 25mm diameter only
Special sizes available on request



HOW TO SPECIFY

Product No. / Diameter / Projection / Finish / Fixing (refer diagram below)

eg: 6500A / 25 / 70 / SSS / D Fix GD

B = BACK TO BACK FIX

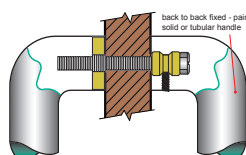

D = DISK FIX

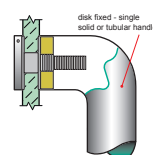

C = CONCEALED FIX

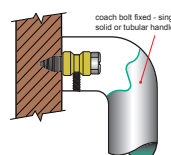

PLEASE SPECIFY DOOR TYPE

- GD** - Glass doors
- TM** - Timber doors
- AL** - Aluminium doors

Entry Door Pull Handle

Material 316 Marine Grade Stainless Steel

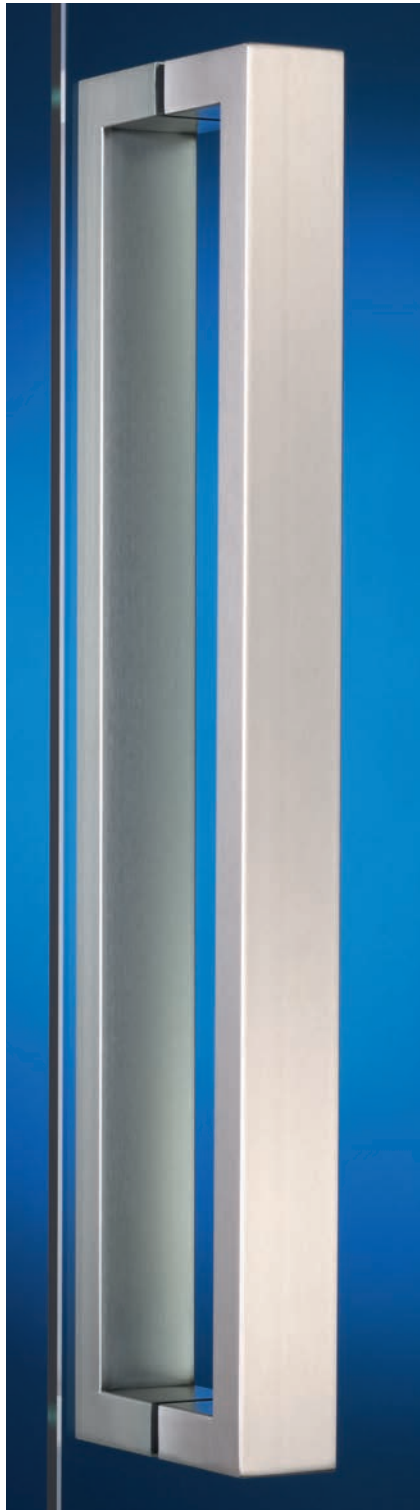

| Product No. | Fixing Centres mm | Rail Section mm | Unit | Projection mm | Overall Length mm |
|-------------|-------------------|-----------------|------|---------------|-------------------|
|-------------|-------------------|-----------------|------|---------------|-------------------|

Back to Back Fix

| | | | | | |
|------------------|------|-------|------|----|------|
| MDZ B8000 | 1500 | 50x25 | Pair | 75 | 1525 |
| MDZ B8000 | 1000 | 50x25 | Pair | 75 | 1025 |
| MDZ B8000 | 800 | 50x25 | Pair | 75 | 825 |
| MDZ B8000 | 600 | 50x25 | Pair | 75 | 625 |
| MDZ B8000 | 400 | 50x25 | Pair | 75 | 425 |

Disk Fix

| | | | | | |
|------------------|------|-------|--------|----|------|
| MDZ D8000 | 1500 | 50x25 | Single | 75 | 1525 |
| MDZ D8000 | 1000 | 50x25 | Single | 75 | 1025 |
| MDZ D8000 | 800 | 50x25 | Single | 75 | 825 |
| MDZ D8000 | 600 | 50x25 | Single | 75 | 625 |
| MDZ D8000 | 400 | 50x25 | Single | 75 | 425 |

Concealed Fix

| | | | | | |
|------------------|------|-------|--------|----|------|
| MDZ C8000 | 1500 | 50x25 | Single | 75 | 1525 |
| MDZ C8000 | 1000 | 50x25 | Single | 75 | 1025 |
| MDZ C8000 | 800 | 50x25 | Single | 75 | 825 |
| MDZ C8000 | 600 | 50x25 | Single | 75 | 625 |
| MDZ C8000 | 400 | 50x25 | Single | 75 | 425 |

NOTE:

MDZ 8000 Series come in fixing centres from 400mm to 2000mm, in 100mm increments. Available in all fixes. Special sizes available on request



HOW TO SPECIFY

Product No. / Fixing Centres / Rail Section / Finish / Fixing (refer diagram below)

eg: B8000 / 800 / 50x25 / SSS / TM

B = BACK TO BACK FIX

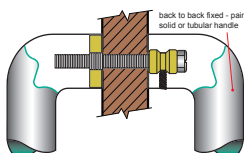

D = DISK FIX

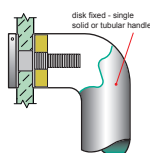

C = CONCEALED FIX

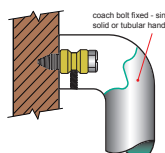

PLEASE SPECIFY DOOR TYPE

GD - Glass doors

TM - Timber doors

AL - Aluminium doors

Entry Door Pull Handle

Material 316 Marine Grade Stainless Steel

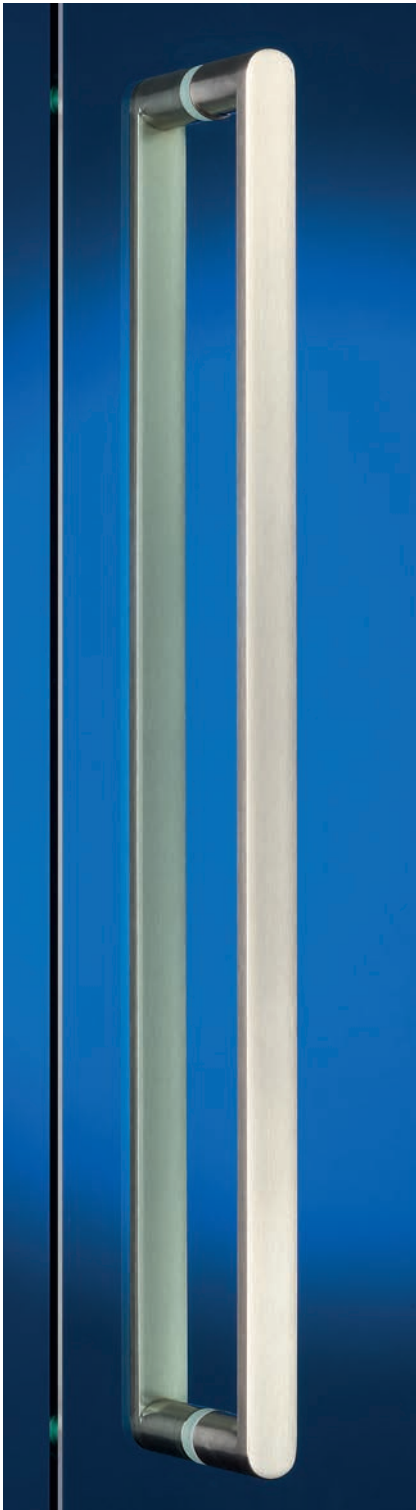

| Product No. | Fixing Centres mm | Rail Section mm | Unit | Projection mm | Overall Length mm |
|-------------------------|-------------------|-----------------|--------|---------------|-------------------|
| Back to Back Fix | | | | | |
| MDZ B8005 | 900 | 25x10 | Pair | 55 | 925 |
| MDZ B8005 | 600 | 25x10 | Pair | 55 | 625 |
| MDZ B8005 | 450 | 25x10 | Pair | 55 | 475 |
| MDZ B8005 | 300 | 25x10 | Pair | 55 | 325 |
| Disk Fix | | | | | |
| MDZ D8005 | 900 | 25x10 | Single | 55 | 925 |
| MDZ D8005 | 600 | 25x10 | Single | 55 | 625 |
| MDZ D8005 | 450 | 25x10 | Single | 55 | 475 |
| MDZ D8005 | 300 | 25x10 | Single | 55 | 325 |
| Concealed Fix | | | | | |
| MDZ C8005 | 900 | 25x10 | Single | 55 | 925 |
| MDZ C8005 | 600 | 25x10 | Single | 55 | 625 |
| MDZ C8005 | 450 | 25x10 | Single | 55 | 475 |
| MDZ C8005 | 300 | 25x10 | Single | 55 | 325 |

NOTE:
Special sizes available on request



HOW TO SPECIFY

Product No. / Fixing Centres / Rail Section / Finish / Fixing (refer diagram below)
eg: B8005 / 900 / 25x10 / SSS / TM

B = BACK TO BACK FIX

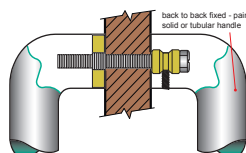

D = DISK FIX

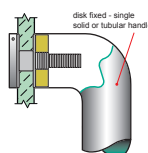

C = CONCEALED FIX

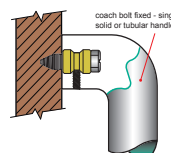

PLEASE SPECIFY DOOR TYPE

- GD** - Glass doors
- TM** - Timber doors
- AL** - Aluminium doors

Entry Door Pull Handle Design Registration No.147909 Copyright Reserved

Material 316 Marine Grade Stainless Steel

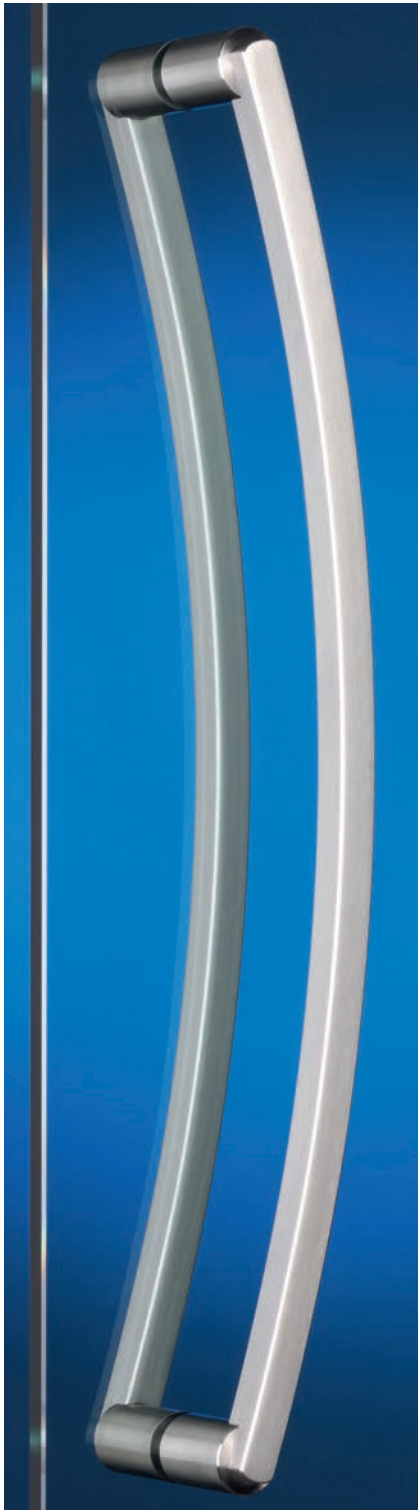

| Product No. | Fixing Centres mm | Square Tube mm | Unit | Projection mm | Width mm | Overall Length mm |
|-------------------------|-------------------|----------------|--------|---------------|----------|-------------------|
| Back to Back Fix | | | | | | |
| MDZ B8010 | 600 | 19 | Pair | 55 | 80 | 632 |
| Disk Fix | | | | | | |
| MDZ D8010 | 600 | 19 | Single | 55 | 80 | 632 |
| Concealed Fix | | | | | | |
| MDZ C8010 | 600 | 19 | Single | 55 | 80 | 632 |



HOW TO SPECIFY

Product No. / Fixing Centres / Square Tube / Finish / Fixing (refer diagram below)

eg: B8010 / 600 / 19 / SSS / TM

B = BACK TO BACK FIX

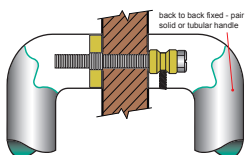

D = DISK FIX

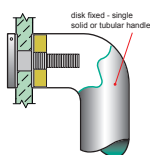

C = CONCEALED FIX

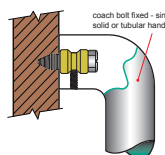

PLEASE SPECIFY DOOR TYPE

GD - Glass doors

TM - Timber doors

AL - Aluminium doors

Entry Door Pull Handle Design Registration No.147942 Copyright Reserved

Material 316 Marine Grade Stainless Steel

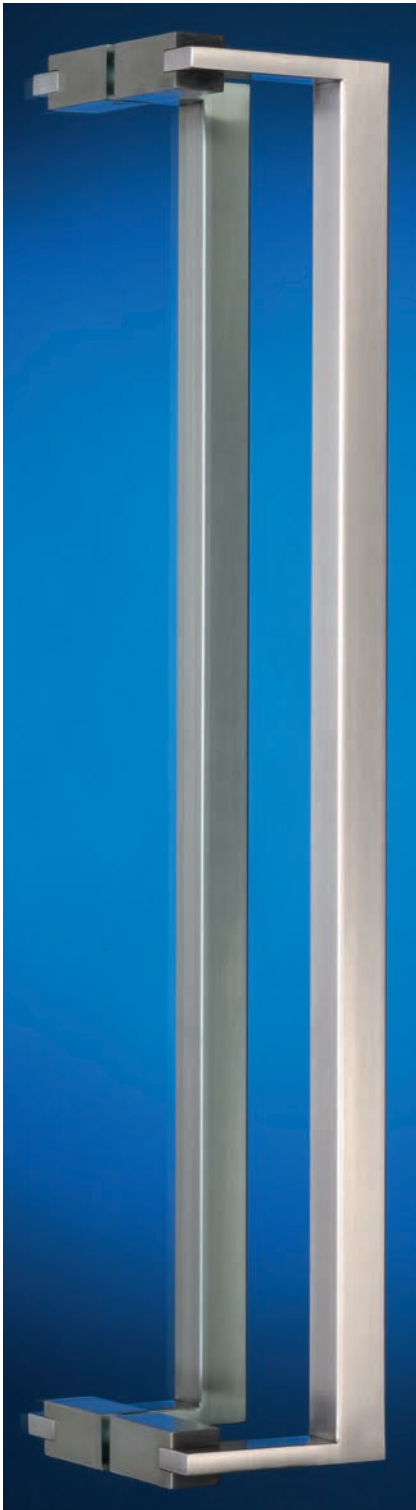

| Product No. | Fixing Centres mm | Square Tube mm | Unit | Projection mm | Width mm | Overall Length mm |
|-------------|-------------------|----------------|------|---------------|----------|-------------------|
|-------------|-------------------|----------------|------|---------------|----------|-------------------|

Back to Back Fix

| | | | | | | |
|------------------|------|----|------|----|-----|------|
| MDZ B8020 | 1500 | 25 | Pair | 70 | 100 | 1525 |
| MDZ B8020 | 1000 | 25 | Pair | 70 | 100 | 1025 |
| MDZ B8020 | 800 | 25 | Pair | 70 | 100 | 825 |
| MDZ B8020 | 600 | 25 | Pair | 70 | 100 | 625 |
| MDZ B8020 | 400 | 25 | Pair | 70 | 100 | 425 |

Disk Fix

| | | | | | | |
|------------------|------|----|--------|----|-----|------|
| MDZ D8020 | 1500 | 25 | Single | 70 | 100 | 1525 |
| MDZ D8020 | 1000 | 25 | Single | 70 | 100 | 1025 |
| MDZ D8020 | 800 | 25 | Single | 70 | 100 | 825 |
| MDZ D8020 | 600 | 25 | Single | 70 | 100 | 625 |
| MDZ D8020 | 400 | 25 | Single | 70 | 100 | 425 |

Concealed Fix

| | | | | | | |
|------------------|------|----|--------|----|-----|------|
| MDZ C8020 | 1500 | 25 | Single | 70 | 100 | 1525 |
| MDZ C8020 | 1000 | 25 | Single | 70 | 100 | 1025 |
| MDZ C8020 | 800 | 25 | Single | 70 | 100 | 825 |
| MDZ C8020 | 600 | 25 | Single | 70 | 100 | 625 |
| MDZ C8020 | 400 | 25 | Single | 70 | 100 | 425 |

NOTE:
Special sizes available on request



HOW TO SPECIFY

Product No. / Fixing Centres / Square Tube / Finish / Fixing (refer diagram below)

eg: B8020 / 1000 / 25 / SSS / TM

B = BACK TO BACK FIX

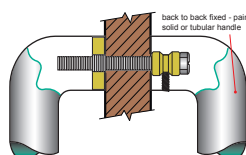

D = DISK FIX

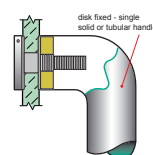

C = CONCEALED FIX

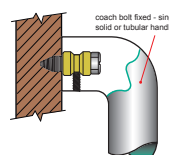

PLEASE SPECIFY DOOR TYPE

GD - Glass doors

TM - Timber doors

AL - Aluminium doors

Entry Door Pull Handle

Material 316 Marine Grade Stainless Steel

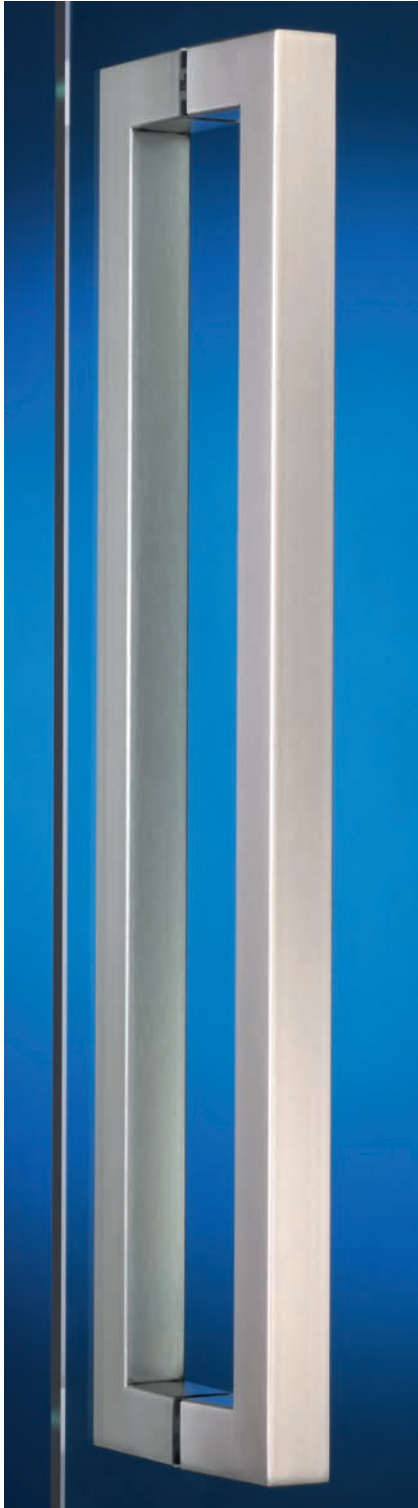

| Product No. | Fixing Centres mm | Square Tube mm | | | Unit | Projection mm | | | Overall Length mm | | |
|-------------|-------------------|----------------|--|--|------|---------------|--|--|-------------------|--|--|
|-------------|-------------------|----------------|--|--|------|---------------|--|--|-------------------|--|--|

Back to Back Fix

| | | | | | | | | | | | |
|------------------|------|----|----|----|------|----|----|----|------|------|------|
| MDZ B8030 | 1500 | 32 | 25 | 19 | Pair | 77 | 70 | 65 | 1532 | 1525 | 1519 |
| MDZ B8030 | 1000 | 32 | 25 | 19 | Pair | 77 | 70 | 65 | 1032 | 1025 | 1019 |
| MDZ B8030 | 800 | 32 | 25 | 19 | Pair | 77 | 70 | 65 | 832 | 825 | 819 |
| MDZ B8030 | 600 | 32 | 25 | 19 | Pair | 77 | 70 | 65 | 632 | 625 | 619 |
| MDZ B8030 | 400 | 32 | 25 | 19 | Pair | 77 | 70 | 65 | 432 | 425 | 419 |

Disk Fix

| | | | | | | | | | | | |
|------------------|------|----|----|----|--------|----|----|----|------|------|------|
| MDZ D8030 | 1500 | 32 | 25 | 19 | Single | 77 | 70 | 65 | 1532 | 1525 | 1519 |
| MDZ D8030 | 1000 | 32 | 25 | 19 | Single | 77 | 70 | 65 | 1032 | 1025 | 1019 |
| MDZ D8030 | 800 | 32 | 25 | 19 | Single | 77 | 70 | 65 | 832 | 825 | 819 |
| MDZ D8030 | 600 | 32 | 25 | 19 | Single | 77 | 70 | 65 | 632 | 625 | 619 |
| MDZ D8030 | 400 | 32 | 25 | 19 | Single | 77 | 70 | 65 | 432 | 425 | 419 |

Concealed Fix

| | | | | | | | | | | | |
|------------------|------|----|----|----|--------|----|----|----|------|------|------|
| MDZ C8030 | 1500 | 32 | 25 | 19 | Single | 77 | 70 | 65 | 1532 | 1525 | 1519 |
| MDZ C8030 | 1000 | 32 | 25 | 19 | Single | 77 | 70 | 65 | 1032 | 1025 | 1019 |
| MDZ C8030 | 800 | 32 | 25 | 19 | Single | 77 | 70 | 65 | 832 | 825 | 819 |
| MDZ C8030 | 600 | 32 | 25 | 19 | Single | 77 | 70 | 65 | 632 | 625 | 619 |
| MDZ C8030 | 400 | 32 | 25 | 19 | Single | 77 | 70 | 65 | 432 | 425 | 419 |

NOTE:

Also available in all fixes

MDZ 8030 Series in 32mm diameter come in fixing centres from 400mm to 2400mm, in 100mm increments.

MDZ 8030 Series in 25mm diameter come in fixing centres from 400mm to 2000mm, in 100mm increments.

MDZ 8030 Series in 19mm diameter come in fixing centres from 400mm to 1500mm, in 100mm increments.



HOW TO SPECIFY

Product No. / Fixing Centres / Square Tube / Finish / Fixing (refer diagram below)

eg: B8030 / 800 / 25 / SSS / TM

B = BACK TO BACK FIX

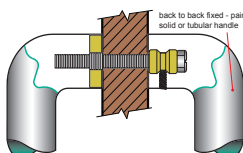

D = DISK FIX

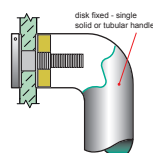

C = CONCEALED FIX

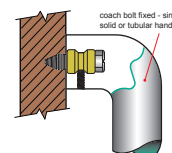

PLEASE SPECIFY DOOR TYPE

GD - Glass doors

TM - Timber doors

AL - Aluminium doors



| Product No. | Fixing Centres mm | Flat Plate mm | Unit | Projection mm | Width mm | Overall Length mm |
|-------------------------|-------------------|---------------|--------|---------------|----------|-------------------|
| Back to Back Fix | | | | | | |
| MDZ B8040 | 150 | 6 | Pair | 51 | 150 | 250 |
| Disk Fix | | | | | | |
| MDZ D8040 | 150 | 6 | Single | 51 | 150 | 250 |
| Concealed Fix | | | | | | |
| MDZ C8040 | 150 | 6 | Single | 51 | 150 | 250 |

Entry Door Pull Handle

Material 316 Marine Grade Stainless Steel

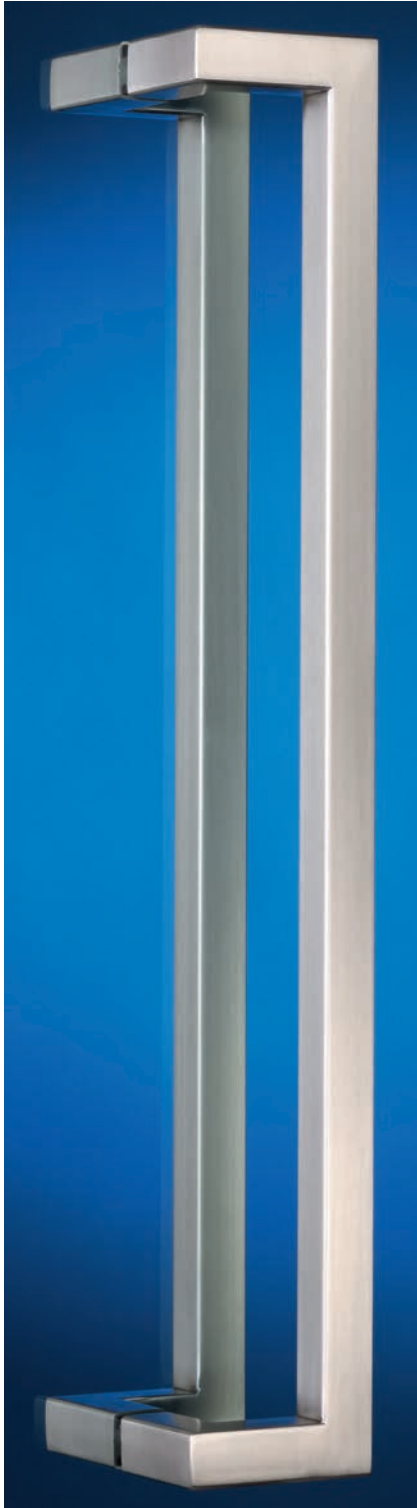

| Product No. | Fixing Centres mm | Square Tube mm | | | Unit | Projection mm | | | Width mm | | | Overall Length mm | | |
|-------------|-------------------|----------------|--|--|------|---------------|--|--|----------|--|--|-------------------|--|--|
|-------------|-------------------|----------------|--|--|------|---------------|--|--|----------|--|--|-------------------|--|--|

Back to Back Fix

| | | | | | | | | | | | | | | |
|------------------|------|----|----|----|------|----|----|----|----|----|----|------|------|------|
| MDZ B8050 | 1500 | 32 | 25 | 19 | Pair | 72 | 65 | 60 | 90 | 90 | 90 | 1532 | 1525 | 1519 |
| MDZ B8050 | 1000 | 32 | 25 | 19 | Pair | 72 | 65 | 60 | 90 | 90 | 90 | 1032 | 1025 | 1019 |
| MDZ B8050 | 800 | 32 | 25 | 19 | Pair | 72 | 65 | 60 | 90 | 90 | 90 | 832 | 825 | 819 |
| MDZ B8050 | 600 | 32 | 25 | 19 | Pair | 72 | 65 | 60 | 90 | 90 | 90 | 632 | 625 | 619 |
| MDZ B8050 | 400 | 32 | 25 | 19 | Pair | 72 | 65 | 60 | 90 | 90 | 90 | 432 | 425 | 419 |

Disk Fix

| | | | | | | | | | | | | | | |
|------------------|------|----|----|----|--------|----|----|----|----|----|----|------|------|------|
| MDZ D8050 | 1500 | 32 | 25 | 19 | Single | 72 | 65 | 60 | 90 | 90 | 90 | 1532 | 1525 | 1519 |
| MDZ D8050 | 1000 | 32 | 25 | 19 | Single | 72 | 65 | 60 | 90 | 90 | 90 | 1032 | 1025 | 1019 |
| MDZ D8050 | 800 | 32 | 25 | 19 | Single | 72 | 65 | 60 | 90 | 90 | 90 | 832 | 825 | 819 |
| MDZ D8050 | 600 | 32 | 25 | 19 | Single | 72 | 65 | 60 | 90 | 90 | 90 | 632 | 625 | 619 |
| MDZ D8050 | 400 | 32 | 25 | 19 | Single | 72 | 65 | 60 | 90 | 90 | 90 | 432 | 425 | 419 |

Concealed Fix

| | | | | | | | | | | | | | | |
|------------------|------|----|----|----|--------|----|----|----|----|----|----|------|------|------|
| MDZ C8050 | 1500 | 32 | 25 | 19 | Single | 72 | 65 | 60 | 90 | 90 | 90 | 1532 | 1525 | 1519 |
| MDZ C8050 | 1000 | 32 | 25 | 19 | Single | 72 | 65 | 60 | 90 | 90 | 90 | 1032 | 1025 | 1019 |
| MDZ C8050 | 800 | 32 | 25 | 19 | Single | 72 | 65 | 60 | 90 | 90 | 90 | 832 | 825 | 819 |
| MDZ C8050 | 600 | 32 | 25 | 19 | Single | 72 | 65 | 60 | 90 | 90 | 90 | 632 | 625 | 619 |
| MDZ C8050 | 400 | 32 | 25 | 19 | Single | 72 | 65 | 60 | 90 | 90 | 90 | 432 | 425 | 419 |

NOTE:

Also available in all fixes

MDZ 8050 Series in 32mm diameter come in fixing centres from 400mm to 2400mm, in 100mm increments.

MDZ 8050 Series in 25mm diameter come in fixing centres from 400mm to 2000mm, in 100mm increments.

MDZ 8050 Series in 19mm diameter come in fixing centres from 400mm to 1500mm, in 100mm increments.



HOW TO SPECIFY

Product No. / Fixing Centres / Square Tube / Finish / Fixing (refer diagram below)

eg: B8050 / 800 / 25 / SSS / TM

B = BACK TO BACK FIX

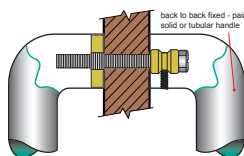

back to back fixed - pair solid or tubular handle

D = DISK FIX

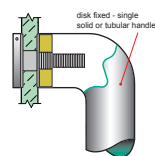

disk fixed - single solid or tubular handle

C = CONCEALED FIX

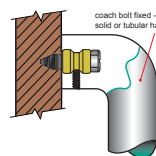

conceal bolt fixed - single solid or tubular handle

PLEASE SPECIFY DOOR TYPE

GD - Glass doors

TM - Timber doors

AL - Aluminium doors

Entry Door Pull Handle Design Registration No.147941 Copyright Reserved

Material 316 Marine Grade Stainless Steel

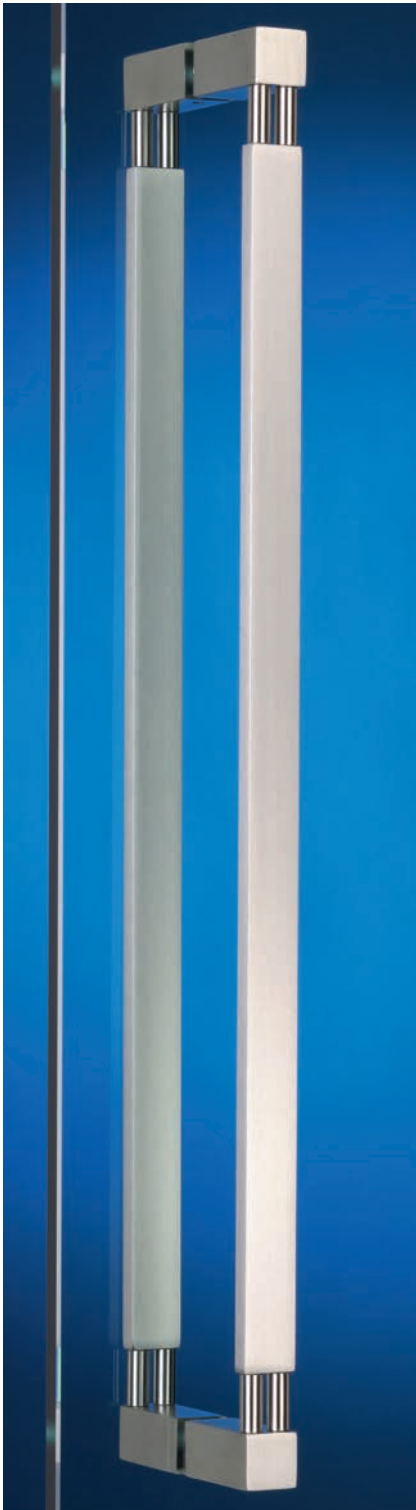

| Product No. | Fixing Centres mm | Flat Bar mm | Unit | Projection mm | Overall Length mm |
|-------------|-------------------|-------------|------|---------------|-------------------|
|-------------|-------------------|-------------|------|---------------|-------------------|

Back to Back Fix

| | | | | | |
|------------------|-----|-------|------|----|-----|
| MDZ B8060 | 800 | 25x10 | Pair | 57 | 825 |
| MDZ B8060 | 600 | 25x10 | Pair | 57 | 625 |
| MDZ B8060 | 400 | 25x10 | Pair | 57 | 425 |

Disk Fix

| | | | | | |
|------------------|-----|-------|--------|----|-----|
| MDZ D8060 | 800 | 25x10 | Single | 57 | 825 |
| MDZ D8060 | 600 | 25x10 | Single | 57 | 625 |
| MDZ D8060 | 400 | 25x10 | Single | 57 | 425 |

Concealed Fix

| | | | | | |
|------------------|-----|-------|--------|----|-----|
| MDZ C8060 | 800 | 25x10 | Single | 57 | 825 |
| MDZ C8060 | 600 | 25x10 | Single | 57 | 625 |
| MDZ C8060 | 400 | 25x10 | Single | 57 | 425 |

HOW TO SPECIFY

Product No. / Fixing Centres / Flat Bar / Finish / Fixing (refer diagram below)

eg: B8060 / 600 / 25x10 / SSS / TM

B = BACK TO BACK FIX

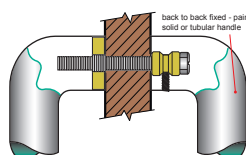

D = DISK FIX

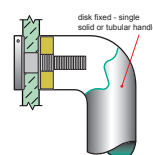

C = CONCEALED FIX

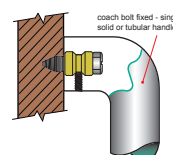

PLEASE SPECIFY DOOR TYPE

GD - Glass doors

TM - Timber doors

AL - Aluminium doors



| Product No. | Fixing Centres mm | Flat Bar mm | Unit | Projection mm | Overall Length mm |
|-------------------------|-------------------|-------------|--------|---------------|-------------------|
| Back to Back Fix | | | | | |
| MDZ B8070 | 270 | 40x8 | Pair | 53 | 400 |
| Disk Fix | | | | | |
| MDZ D8070 | 270 | 40x8 | Single | 53 | 400 |
| Concealed Fix | | | | | |
| MDZ C8070 | 270 | 40x8 | Single | 53 | 400 |



HOW TO SPECIFY

Product No. / Fixing Centres / Flat Bar / Finish / Fixing (refer diagram below)

eg: B8070 / 270 / 40x8 / SSS / TM

B = BACK TO BACK FIX

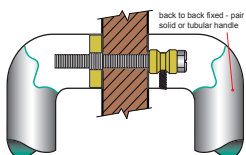

D = DISK FIX

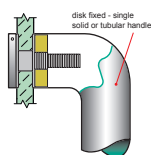

C = CONCEALED FIX

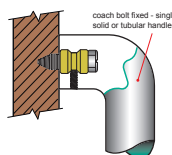

PLEASE SPECIFY DOOR TYPE

GD - Glass doors

TM - Timber doors

AL - Aluminium doors

Entry Door Pull Handle Design Registration No.147879 Copyright Reserved

Material 316 Marine Grade Stainless Steel

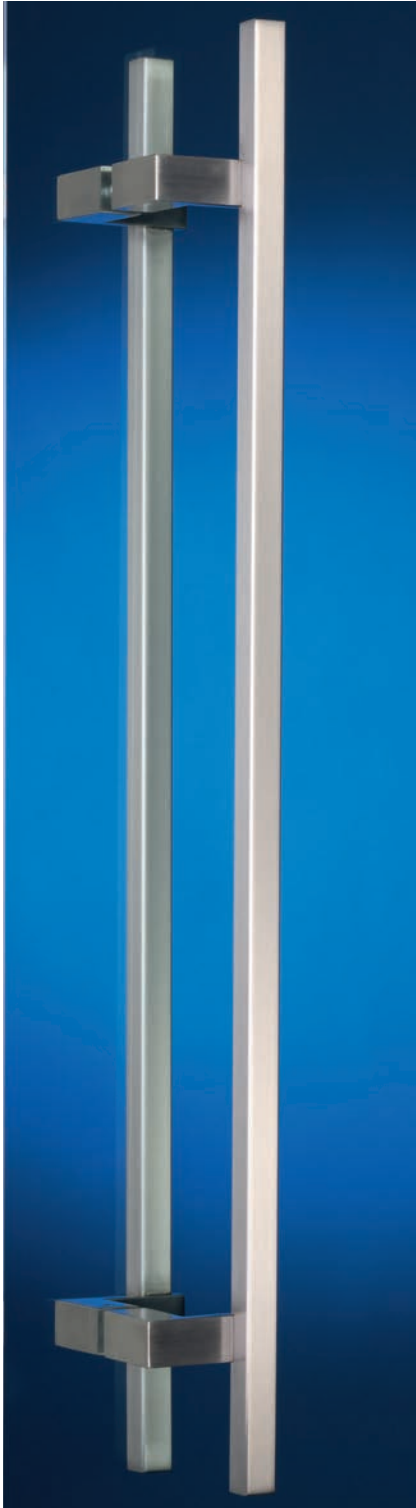

| Product No. | Fixing Centres mm | Square Tube mm | Unit | Projection mm | Width mm | Overall Length mm |
|-------------|-------------------|----------------|------|---------------|----------|-------------------|
|-------------|-------------------|----------------|------|---------------|----------|-------------------|

Back to Back Fix

| | | | | | | |
|-----------|------|----|------|----|----|------|
| MDZ B8080 | 1340 | 19 | Pair | 65 | 75 | 1500 |
| MDZ B8080 | 840 | 19 | Pair | 65 | 75 | 1000 |
| MDZ B8080 | 640 | 19 | Pair | 65 | 75 | 800 |
| MDZ B8080 | 440 | 19 | Pair | 65 | 75 | 600 |
| MDZ B8080 | 240 | 19 | Pair | 65 | 75 | 400 |

Disk Fix

| | | | | | | |
|-----------|------|----|--------|----|----|------|
| MDZ D8080 | 1340 | 19 | Single | 65 | 75 | 1500 |
| MDZ D8080 | 840 | 19 | Single | 65 | 75 | 1000 |
| MDZ D8080 | 640 | 19 | Single | 65 | 75 | 800 |
| MDZ D8080 | 440 | 19 | Single | 65 | 75 | 600 |
| MDZ D8080 | 240 | 19 | Single | 65 | 75 | 400 |

Concealed Fix

| | | | | | | |
|-----------|------|----|--------|----|----|------|
| MDZ C8080 | 1340 | 19 | Single | 65 | 75 | 1500 |
| MDZ C8080 | 840 | 19 | Single | 65 | 75 | 1000 |
| MDZ C8080 | 640 | 19 | Single | 65 | 75 | 800 |
| MDZ C8080 | 440 | 19 | Single | 65 | 75 | 600 |
| MDZ C8080 | 240 | 19 | Single | 65 | 75 | 400 |

NOTE:
Special sizes available on request



HOW TO SPECIFY

Product No. / Fixing Centres / Square Tube / Finish / Fixing (refer diagram below)

eg: B8080 / 1340 / 19 / SSS / TM

B = BACK TO BACK FIX

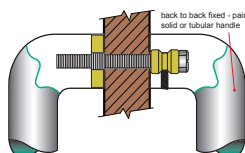

D = DISK FIX

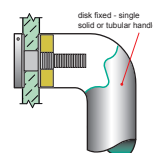

C = CONCEALED FIX

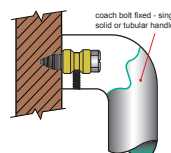

PLEASE SPECIFY DOOR TYPE

GD - Glass doors

TM - Timber doors

AL - Aluminium doors



| Product No. | Fixing Centres mm | Tube Diameter mm | Unit | Projection mm | Width mm | Overall Length mm |
|-------------|-------------------|------------------|------|---------------|----------|-------------------|
|-------------|-------------------|------------------|------|---------------|----------|-------------------|

Back to Back Fix

| | | | | | | |
|------------------|------|----|------|----|----|------|
| MDZ B8090 | 1340 | 25 | Pair | 71 | 75 | 1500 |
| MDZ B8090 | 840 | 25 | Pair | 71 | 75 | 1000 |
| MDZ B8090 | 640 | 25 | Pair | 71 | 75 | 800 |
| MDZ B8090 | 440 | 25 | Pair | 71 | 75 | 600 |
| MDZ B8090 | 240 | 25 | Pair | 71 | 75 | 400 |

Disk Fix

| | | | | | | |
|------------------|------|----|--------|----|----|------|
| MDZ D8090 | 1340 | 25 | Single | 71 | 75 | 1500 |
| MDZ D8090 | 840 | 25 | Single | 71 | 75 | 1000 |
| MDZ D8090 | 640 | 25 | Single | 71 | 75 | 800 |
| MDZ D8090 | 440 | 25 | Single | 71 | 75 | 600 |
| MDZ D8090 | 240 | 25 | Single | 71 | 75 | 400 |

Concealed Fix

| | | | | | | |
|------------------|------|----|--------|----|----|------|
| MDZ C8090 | 1340 | 25 | Single | 71 | 75 | 1500 |
| MDZ C8090 | 840 | 25 | Single | 71 | 75 | 1000 |
| MDZ C8090 | 640 | 25 | Single | 71 | 75 | 800 |
| MDZ C8090 | 440 | 25 | Single | 71 | 75 | 600 |
| MDZ C8090 | 240 | 25 | Single | 71 | 75 | 400 |

NOTE:
Special sizes available on request



HOW TO SPECIFY

Product No. / Fixing Centres / Tube Diameter / Finish / Fixing (refer diagram below)

eg: B8090 / 440 / 25 / SSS / TM

B = BACK TO BACK FIX

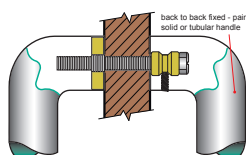

D = DISK FIX

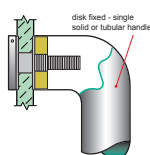

C = CONCEALED FIX

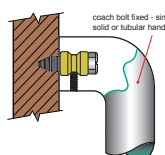

PLEASE SPECIFY DOOR TYPE

GD - Glass doors

TM - Timber doors

AL - Aluminium doors

Entry Door Pull Handle Design Registration No.147881 Copyright Reserved

Material 316 Marine Grade Stainless Steel



| Product No. | Fixing Centres mm | Flat Bar mm | Unit | Projection mm | Overall Length mm |
|-------------------------|-------------------|-------------|--------|---------------|-------------------|
| Back to Back Fix | | | | | |
| MDZ B8100 | 600 | 40x10 | Pair | 65 | 645 |
| Disk Fix | | | | | |
| MDZ D8100 | 600 | 40x10 | Single | 65 | 645 |
| Concealed Fix | | | | | |
| MDZ C8100 | 600 | 40x10 | Single | 65 | 645 |

HOW TO SPECIFY

Product No. / Fixing Centres / Flat Bar / Finish / Fixing (refer diagram below)

eg: B8100 / 600 / 40x10 / SSS / TM

B = BACK TO BACK FIX

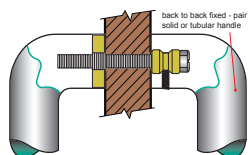

D = DISK FIX

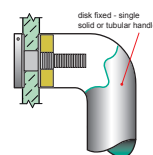

C = CONCEALED FIX

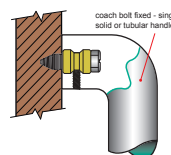

PLEASE SPECIFY DOOR TYPE

GD - Glass doors

TM - Timber doors

AL - Aluminium doors

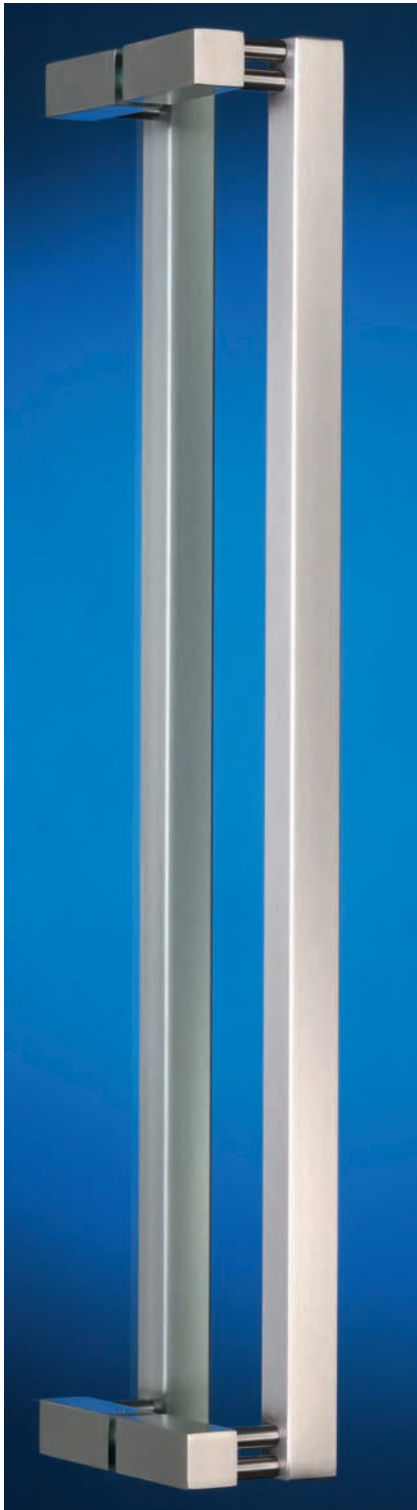

| Product No. | Fixing Centres mm | Square Tube mm | Unit | Projection mm | Width mm | Overall Length mm |
|-------------|-------------------|----------------|------|---------------|----------|-------------------|
|-------------|-------------------|----------------|------|---------------|----------|-------------------|

Back to Back Fix

| | | | | | | |
|------------------|------|----|------|----|----|------|
| MDZ B8110 | 1500 | 25 | Pair | 65 | 75 | 1525 |
| MDZ B8110 | 1000 | 25 | Pair | 65 | 75 | 1025 |
| MDZ B8110 | 800 | 25 | Pair | 65 | 75 | 825 |
| MDZ B8110 | 600 | 25 | Pair | 65 | 75 | 625 |
| MDZ B8110 | 400 | 25 | Pair | 65 | 75 | 425 |

Disk Fix

| | | | | | | |
|------------------|------|----|--------|----|----|------|
| MDZ D8110 | 1500 | 25 | Single | 65 | 75 | 1525 |
| MDZ D8110 | 1000 | 25 | Single | 65 | 75 | 1025 |
| MDZ D8110 | 800 | 25 | Single | 65 | 75 | 825 |
| MDZ D8110 | 600 | 25 | Single | 65 | 75 | 625 |
| MDZ D8110 | 400 | 25 | Single | 65 | 75 | 425 |

Concealed Fix

| | | | | | | |
|------------------|------|----|--------|----|----|------|
| MDZ C8110 | 1500 | 25 | Single | 65 | 75 | 1525 |
| MDZ C8110 | 1000 | 25 | Single | 65 | 75 | 1025 |
| MDZ C8110 | 800 | 25 | Single | 65 | 75 | 825 |
| MDZ C8110 | 600 | 25 | Single | 65 | 75 | 625 |
| MDZ C8110 | 400 | 25 | Single | 65 | 75 | 425 |

NOTE:
Special sizes available on request

HOW TO SPECIFY

Product No. / Fixing Centres / Square Tube / Finish / Fixing (refer diagram below)

eg: B8110 / 800 / 25 / SSS / TM

B = BACK TO BACK FIX

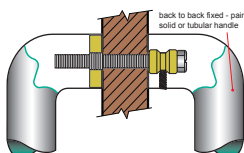

D = DISK FIX

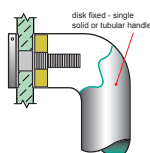

C = CONCEALED FIX

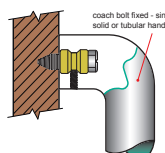

PLEASE SPECIFY DOOR TYPE

GD - Glass doors

TM - Timber doors

AL - Aluminium doors



| Product No. | Fixing Centres mm | Rod Diameter mm | Unit | Projection mm | Width mm | Overall Length mm |
|-------------|-------------------|-----------------|------|---------------|----------|-------------------|
|-------------|-------------------|-----------------|------|---------------|----------|-------------------|

Back to Back Fix

| | | | | | | |
|------------------|-----|----|------|----|----|-----|
| MDZ B8120 | 720 | 12 | Pair | 56 | 75 | 800 |
| MDZ B8120 | 520 | 12 | Pair | 56 | 75 | 600 |
| MDZ B8120 | 320 | 12 | Pair | 56 | 75 | 400 |

Disk Fix

| | | | | | | |
|------------------|-----|----|--------|----|----|-----|
| MDZ D8120 | 720 | 12 | Single | 56 | 75 | 800 |
| MDZ D8120 | 520 | 12 | Single | 56 | 75 | 600 |
| MDZ D8120 | 320 | 12 | Single | 56 | 75 | 400 |

Concealed Fix

| | | | | | | |
|------------------|-----|----|--------|----|----|-----|
| MDZ C8120 | 720 | 12 | Single | 56 | 75 | 800 |
| MDZ C8120 | 520 | 12 | Single | 56 | 75 | 600 |
| MDZ C8120 | 320 | 12 | Single | 56 | 75 | 400 |

NOTE:
Special sizes available on request



HOW TO SPECIFY

Product No. / Fixing Centres / Rod Diameter / Finish / Fixing (refer diagram below)

eg: B8120 / 320 / 12 / SSS / TM

B = BACK TO BACK FIX

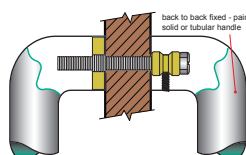

D = DISK FIX

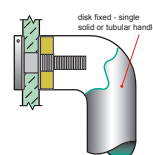

C = CONCEALED FIX

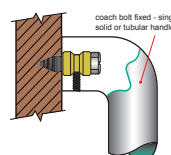

PLEASE SPECIFY DOOR TYPE

GD - Glass doors

TM - Timber doors

AL - Aluminium doors



| Product No. | Fixing Centres mm | Rod Diameter mm | Unit | Projection mm | Overall Length mm |
|-------------|-------------------|-----------------|------|---------------|-------------------|
|-------------|-------------------|-----------------|------|---------------|-------------------|

Back to Back Fix

| | | | | | |
|------------------|-----|----|------|----|-----|
| MDZ B8130 | 720 | 12 | Pair | 55 | 800 |
| MDZ B8130 | 520 | 12 | Pair | 55 | 600 |
| MDZ B8130 | 320 | 12 | Pair | 55 | 400 |

Disk Fix

| | | | | | |
|------------------|-----|----|--------|----|-----|
| MDZ D8130 | 720 | 12 | Single | 55 | 800 |
| MDZ D8130 | 520 | 12 | Single | 55 | 600 |
| MDZ D8130 | 320 | 12 | Single | 55 | 400 |

Concealed Fix

| | | | | | |
|------------------|-----|----|--------|----|-----|
| MDZ C8130 | 720 | 12 | Single | 55 | 800 |
| MDZ C8130 | 520 | 12 | Single | 55 | 600 |
| MDZ C8130 | 320 | 12 | Single | 55 | 400 |

NOTE:
Special sizes available on request



HOW TO SPECIFY

Product No. / Fixing Centres / Rod Diameter / Finish / Fixing (refer diagram below)

eg: B8130 / 720 / 12 / SSS / TM

B = BACK TO BACK FIX

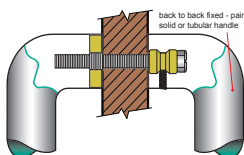

D = DISK FIX

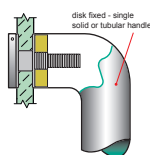

C = CONCEALED FIX

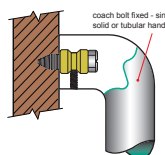

PLEASE SPECIFY DOOR TYPE

GD - Glass doors

TM - Timber doors

AL - Aluminium doors

Entry Door Pull Handle Design Registration No.148052 Copyright Reserved

Material 316 Marine Grade Stainless Steel

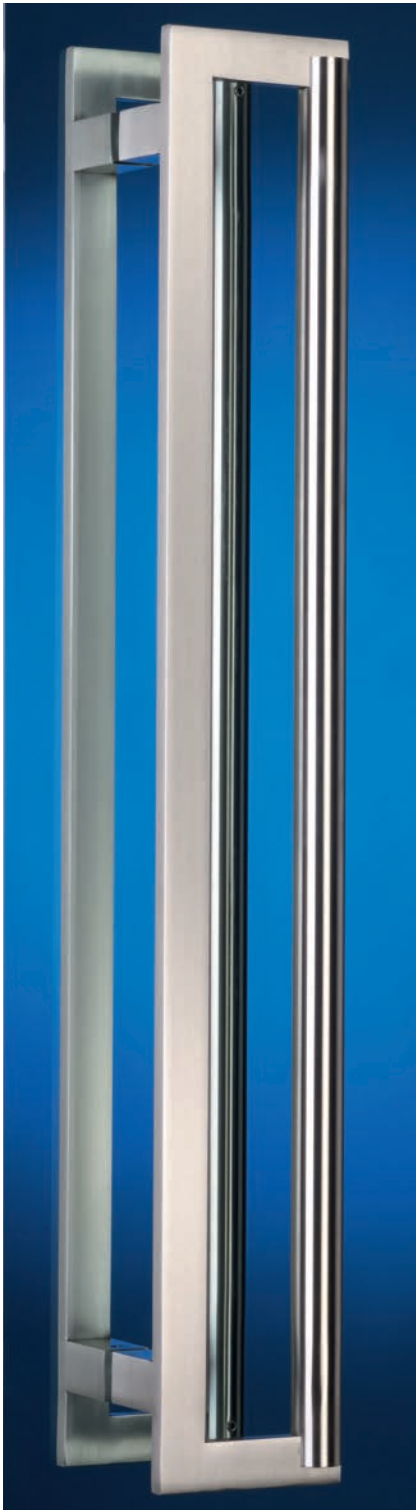

| Product No. | Fixing Centres mm | Tube Diameter mm | Unit | Projection mm | Width mm | Overall Length mm |
|-------------------------|-------------------|------------------|--------|---------------|----------|-------------------|
| Back to Back Fix | | | | | | |
| MDZ B8140 | 400 | 25 | Pair | 60 | 100 | 500 |
| Disk Fix | | | | | | |
| MDZ D8140 | 400 | 25 | Single | 60 | 100 | 500 |
| Concealed Fix | | | | | | |
| MDZ C8140 | 400 | 25 | Single | 60 | 100 | 500 |

NOTE:

Flat bar measures 25mm x 10mm
Special sizes available on request



HOW TO SPECIFY

Product No. / Fixing Centres / Tube Diameter / Finish / Fixing (refer diagram below)
eg: B8140 / 400 / 25 / SSS / TM

B = BACK TO BACK FIX

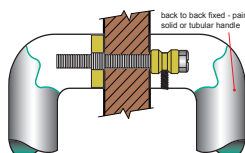

D = DISK FIX

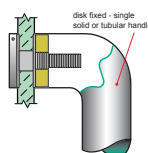

C = CONCEALED FIX

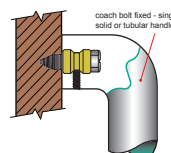

PLEASE SPECIFY DOOR TYPE

GD - Glass doors

TM - Timber doors

AL - Aluminium doors

Entry Door Pull Handle

Material 316 Marine Grade Stainless Steel

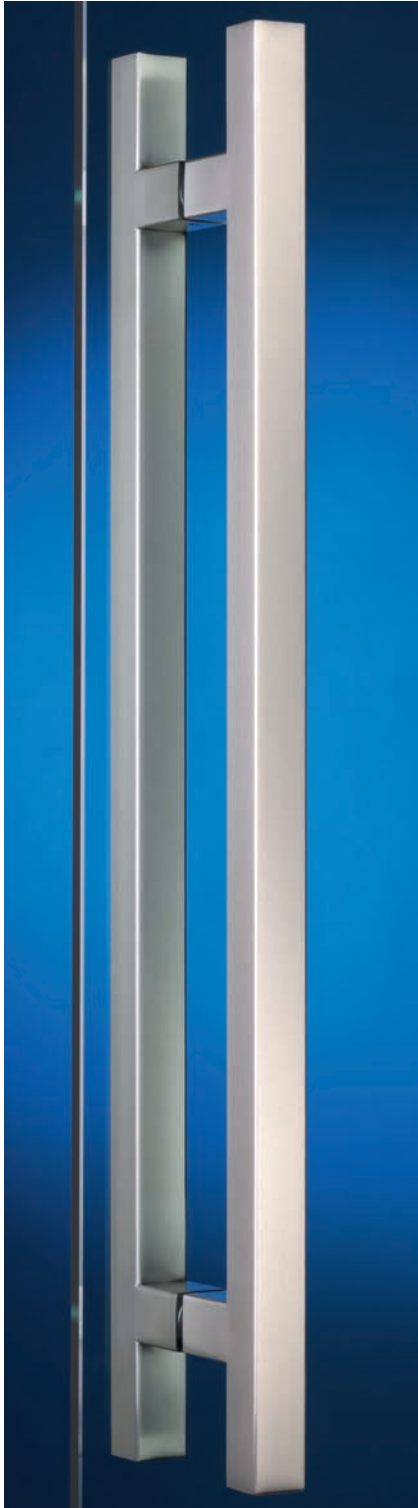

| Product No. | Fixing Centres mm | Square Tube mm | | | Unit | Projection mm | | | Overall Length mm |
|-------------|-------------------|----------------|--|--|------|---------------|--|--|-------------------|
|-------------|-------------------|----------------|--|--|------|---------------|--|--|-------------------|

Back to Back Fix

| | | | | | | | | | |
|------------------|------|----|----|----|------|----|----|----|------|
| MDZ B8150 | 1340 | 32 | 25 | 19 | Pair | 77 | 70 | 65 | 1500 |
| MDZ B8150 | 840 | 32 | 25 | 19 | Pair | 77 | 70 | 65 | 1000 |
| MDZ B8150 | 640 | 32 | 25 | 19 | Pair | 77 | 70 | 65 | 800 |
| MDZ B8150 | 440 | 32 | 25 | 19 | Pair | 77 | 70 | 65 | 600 |
| MDZ B8150 | 240 | 32 | 25 | 19 | Pair | 77 | 70 | 65 | 400 |

Disk Fix

| | | | | | | | | | |
|------------------|------|----|----|----|--------|----|----|----|------|
| MDZ D8150 | 1340 | 32 | 25 | 19 | Single | 77 | 70 | 65 | 1500 |
| MDZ D8150 | 840 | 32 | 25 | 19 | Single | 77 | 70 | 65 | 1000 |
| MDZ D8150 | 640 | 32 | 25 | 19 | Single | 77 | 70 | 65 | 800 |
| MDZ D8150 | 440 | 32 | 25 | 19 | Single | 77 | 70 | 65 | 600 |
| MDZ D8150 | 240 | 32 | 25 | 19 | Single | 77 | 70 | 65 | 400 |

Concealed Fix

| | | | | | | | | | |
|------------------|------|----|----|----|--------|----|----|----|------|
| MDZ C8150 | 1340 | 32 | 25 | 19 | Single | 77 | 70 | 65 | 1500 |
| MDZ C8150 | 840 | 32 | 25 | 19 | Single | 77 | 70 | 65 | 1000 |
| MDZ C8150 | 640 | 32 | 25 | 19 | Single | 77 | 70 | 65 | 800 |
| MDZ C8150 | 440 | 32 | 25 | 19 | Single | 77 | 70 | 65 | 600 |
| MDZ C8150 | 240 | 32 | 25 | 19 | Single | 77 | 70 | 65 | 400 |

NOTE:
Special sizes available on request



HOW TO SPECIFY

Product No. / Fixing Centres / Square Tube / Finish / Fixing (refer diagram below)

eg: B8150 / 840 / 32 / SSS / TM

B = BACK TO BACK FIX

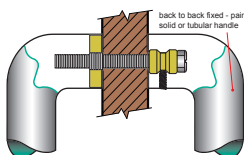

D = DISK FIX

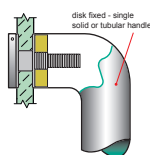

C = CONCEALED FIX

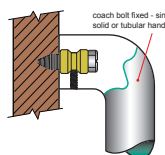

PLEASE SPECIFY DOOR TYPE

GD - Glass doors

TM - Timber doors

AL - Aluminium doors

Entry Door Pull Handle

Material 316 Marine Grade Stainless Steel

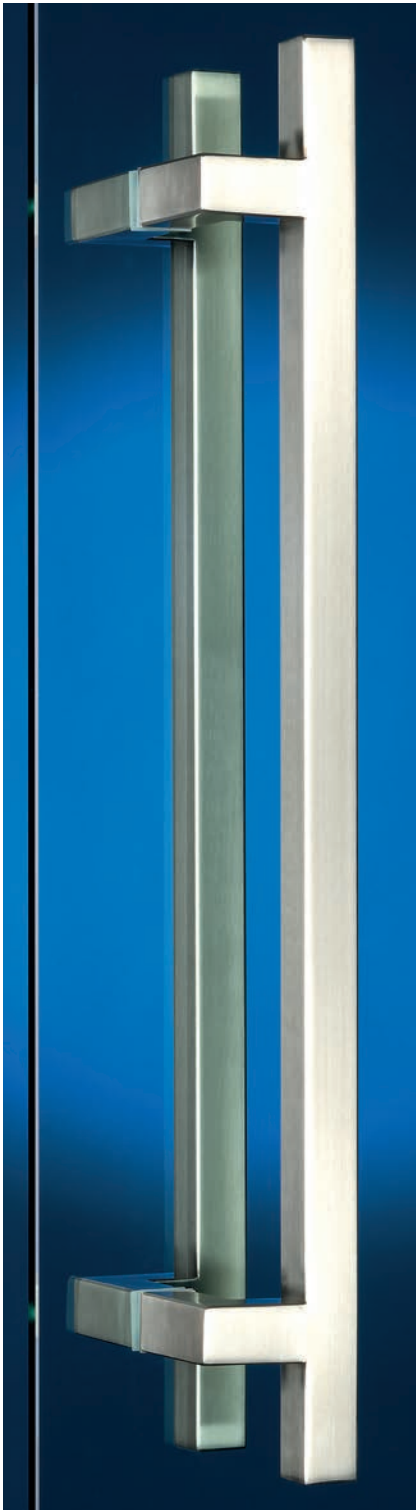

| Product No. | Fixing Centres mm | Square Tube mm | | | Unit | Projection mm | | | Overall Length mm |
|-------------------------|-------------------|----------------|----|----|------|---------------|----|----|-------------------|
| Back to Back Fix | | | | | | | | | |
| MDZ B8155/E | 1840 | 32 | 25 | 19 | Pair | 77 | 70 | 65 | 2000 |
| MDZ B8155/F | 1740 | 32 | 25 | 19 | Pair | 77 | 70 | 65 | 1900 |
| MDZ B8155/G | 1640 | 32 | 25 | 19 | Pair | 77 | 70 | 65 | 1800 |
| MDZ B8155/H | 1540 | 32 | 25 | 19 | Pair | 77 | 70 | 65 | 1700 |
| MDZ B8155/I | 1440 | 32 | 25 | 19 | Pair | 77 | 70 | 65 | 1600 |
| MDZ B8155/J | 1340 | 32 | 25 | 19 | Pair | 77 | 70 | 65 | 1500 |
| MDZ B8155/K | 1240 | 32 | 25 | 19 | Pair | 77 | 70 | 65 | 1400 |
| MDZ B8155/L | 1140 | 32 | 25 | 19 | Pair | 77 | 70 | 65 | 1300 |
| MDZ B8155/M | 1040 | 32 | 25 | 19 | Pair | 77 | 70 | 65 | 1200 |
| MDZ B8155/N | 940 | 32 | 25 | 19 | Pair | 77 | 70 | 65 | 1100 |
| MDZ B8155/O | 840 | 32 | 25 | 19 | Pair | 77 | 70 | 65 | 1000 |
| MDZ B8155/P | 740 | 32 | 25 | 19 | Pair | 77 | 70 | 65 | 900 |
| MDZ B8155/Q | 640 | 32 | 25 | 19 | Pair | 77 | 70 | 65 | 800 |
| MDZ B8155/R | 540 | 32 | 25 | 19 | Pair | 77 | 70 | 65 | 700 |
| MDZ B8155/S | 440 | 32 | 25 | 19 | Pair | 77 | 70 | 65 | 600 |
| MDZ B8155/T | 340 | 32 | 25 | 19 | Pair | 77 | 70 | 65 | 500 |
| MDZ B8155/U | 240 | 32 | 25 | 19 | Pair | 77 | 70 | 65 | 400 |

NOTE:
Special sizes available on request



HOW TO SPECIFY

Product No. / Fixing Centres / Square Tube / Finish / Fixing (refer diagram below)

eg: B8155 / 1840 / 32 / SSS / TM

B = BACK TO BACK FIX

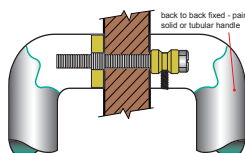

D = DISK FIX

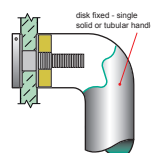

C = CONCEALED FIX

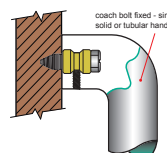

PLEASE SPECIFY DOOR TYPE

GD - Glass doors

TM - Timber doors

AL - Aluminium doors



| Product No. | Fixing Centres mm | Tube Diameter mm | Unit | Projection mm | Width mm | Overall Length mm |
|-------------------------|-------------------|------------------|--------|---------------|----------|-------------------|
| Back to Back Fix | | | | | | |
| MDZ B8160 | 1500 | 25 | Pair | 70 | 90 | 1525 |
| MDZ B8160 | 1000 | 25 | Pair | 70 | 90 | 1025 |
| MDZ B8160 | 800 | 25 | Pair | 70 | 90 | 825 |
| MDZ B8160 | 600 | 25 | Pair | 70 | 90 | 625 |
| Disk Fix | | | | | | |
| MDZ D8160 | 1500 | 25 | Single | 70 | 90 | 1525 |
| MDZ D8160 | 1000 | 25 | Single | 70 | 90 | 1025 |
| MDZ D8160 | 800 | 25 | Single | 70 | 90 | 825 |
| MDZ D8160 | 600 | 25 | Single | 70 | 90 | 625 |
| Concealed Fix | | | | | | |
| MDZ C8160 | 1500 | 25 | Single | 70 | 90 | 1525 |
| MDZ C8160 | 1000 | 25 | Single | 70 | 90 | 1025 |
| MDZ C8160 | 800 | 25 | Single | 70 | 90 | 825 |
| MDZ C8160 | 600 | 25 | Single | 70 | 90 | 625 |

HOW TO SPECIFY

Product No. / Fixing Centres / Tube Diameter / Finish / Fixing (refer diagram below)

eg: B8160 / 800 / 25 / SSS / TM

B = BACK TO BACK FIX

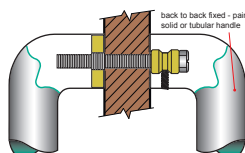

D = DISK FIX

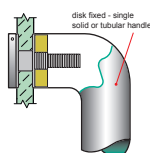

C = CONCEALED FIX

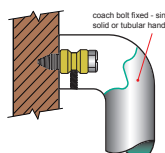

PLEASE SPECIFY DOOR TYPE

GD - Glass doors

TM - Timber doors

AL - Aluminium doors

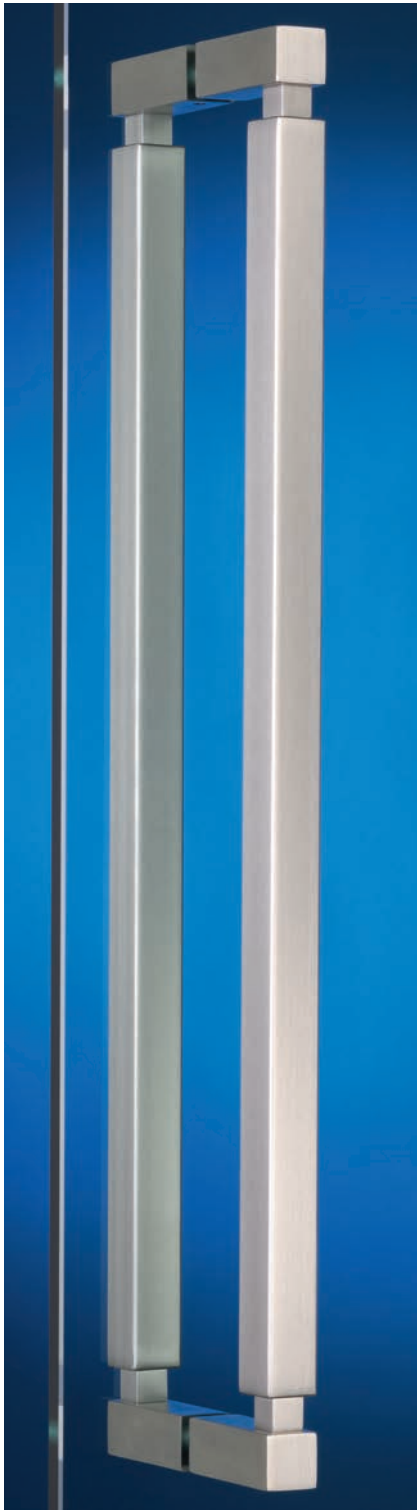

| Product No. | Fixing Centres mm | Square Tube mm | | | Unit | Projection mm | | | Overall Length mm | | |
|-------------|-------------------|----------------|--|--|------|---------------|--|--|-------------------|--|--|
|-------------|-------------------|----------------|--|--|------|---------------|--|--|-------------------|--|--|

Back to Back Fix

| | | | | | | | | | | | |
|------------------|------|----|----|----|------|----|----|----|------|------|------|
| MDZ B8170 | 1500 | 32 | 25 | 19 | Pair | 77 | 70 | 65 | 1532 | 1525 | 1519 |
| MDZ B8170 | 1000 | 32 | 25 | 19 | Pair | 77 | 70 | 65 | 1032 | 1025 | 1019 |
| MDZ B8170 | 800 | 32 | 25 | 19 | Pair | 77 | 70 | 65 | 832 | 825 | 819 |
| MDZ B8170 | 600 | 32 | 25 | 19 | Pair | 77 | 70 | 65 | 632 | 625 | 619 |
| MDZ B8170 | 400 | 32 | 25 | 19 | Pair | 77 | 70 | 65 | 432 | 425 | 419 |

Disk Fix

| | | | | | | | | | | | |
|------------------|------|----|----|----|--------|----|----|----|------|------|------|
| MDZ D8170 | 1500 | 32 | 25 | 19 | Single | 77 | 70 | 65 | 1532 | 1525 | 1519 |
| MDZ D8170 | 1000 | 32 | 25 | 19 | Single | 77 | 70 | 65 | 1032 | 1025 | 1019 |
| MDZ D8170 | 800 | 32 | 25 | 19 | Single | 77 | 70 | 65 | 832 | 825 | 819 |
| MDZ D8170 | 600 | 32 | 25 | 19 | Single | 77 | 70 | 65 | 632 | 625 | 619 |
| MDZ D8170 | 400 | 32 | 25 | 19 | Single | 77 | 70 | 65 | 432 | 425 | 419 |

Concealed Fix

| | | | | | | | | | | | |
|------------------|------|----|----|----|--------|----|-----------|------|------|------|------|
| MDZ C8170 | 1500 | 32 | 25 | 19 | Single | 77 | 70 | 65 | 1532 | 1525 | 1519 |
| MDZ C8170 | 1000 | 32 | 25 | 19 | Single | 77 | 70 <td 65 | 1032 | 1025 | 1019 | |
| MDZ C8170 | 800 | 32 | 25 | 19 | Single | 77 | 70 | 65 | 832 | 825 | 819 |
| MDZ C8170 | 600 | 32 | 25 | 19 | Single | 77 | 70 | 65 | 632 | 625 | 619 |
| MDZ C8170 | 400 | 32 | 25 | 19 | Single | 77 | 70 | 65 | 432 | 425 | 419 |

NOTE:
Special sizes available on request

HOW TO SPECIFY

Product No. / Fixing Centres / Square Tube / Finish / Fixing (refer diagram below)

eg: B8170 / 1000 / 25 / SSS / TM

B = BACK TO BACK FIX

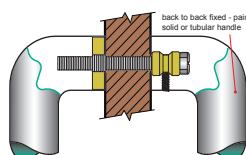

D = DISK FIX

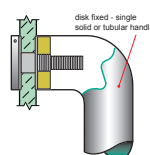

C = CONCEALED FIX

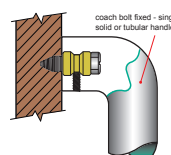

PLEASE SPECIFY DOOR TYPE

GD - Glass doors

TM - Timber doors

AL - Aluminium doors



| Product No. | Fixing Centres mm | Flat Bar mm | Unit | Projection mm | Overall Length mm |
|-------------------------|-------------------|-------------|--------|---------------|-------------------|
| Back to Back Fix | | | | | |
| MDZ B8180 | 500 | 25x10 | Pair | 65 | 600 |
| Disk Fix | | | | | |
| MDZ D8180 | 500 | 25x10 | Single | 65 | 600 |

HOW TO SPECIFY

Product No. / Fixing Centres / Flat Bar / Finish / Fixing (refer diagram below)
eg: B8180 / 500 / 25 / SSS / TM

B = BACK TO BACK FIX

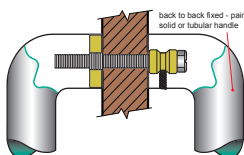

D = DISK FIX

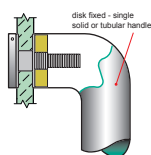

C = CONCEALED FIX

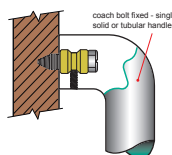

PLEASE SPECIFY DOOR TYPE

- GD** - Glass doors
- TM** - Timber doors
- AL** - Aluminium doors

Entry Door Pull Handle Design Registration No.147911 Copyright Reserved

Material 316 Marine Grade Stainless Steel



| Product No. | Fixing Centres mm | Tube Diameter mm | | Unit | Projection mm | | Width mm | | Overall Length mm | |
|-------------|-------------------|------------------|--|------|---------------|--|----------|--|-------------------|--|
|-------------|-------------------|------------------|--|------|---------------|--|----------|--|-------------------|--|

Back to Back Fix

| | | | | | | | | | | |
|------------------|------|----|----|------|----|----|-----|-----|------|------|
| MDZ B8190 | 1500 | 32 | 25 | Pair | 72 | 65 | 100 | 100 | 1532 | 1525 |
| MDZ B8190 | 1000 | 32 | 25 | Pair | 72 | 65 | 100 | 100 | 1032 | 1025 |
| MDZ B8190 | 800 | 32 | 25 | Pair | 72 | 65 | 100 | 100 | 832 | 825 |
| MDZ B8190 | 600 | 32 | 25 | Pair | 72 | 65 | 100 | 100 | 632 | 625 |
| MDZ B8190 | 400 | 32 | 25 | Pair | 72 | 65 | 100 | 100 | 432 | 425 |

Disk Fix

| | | | | | | | | | | |
|------------------|------|----|----|--------|----|----|-----|-----|------|------|
| MDZ D8190 | 1500 | 32 | 25 | Single | 72 | 65 | 100 | 100 | 1532 | 1525 |
| MDZ D8190 | 1000 | 32 | 25 | Single | 72 | 65 | 100 | 100 | 1032 | 1025 |
| MDZ D8190 | 800 | 32 | 25 | Single | 72 | 65 | 100 | 100 | 832 | 825 |
| MDZ D8190 | 600 | 32 | 25 | Single | 72 | 65 | 100 | 100 | 632 | 625 |
| MDZ D8190 | 400 | 32 | 25 | Single | 72 | 65 | 100 | 100 | 432 | 425 |

Concealed Fix

| | | | | | | | | | | |
|------------------|------|----|----|--------|----|----|-----|-----|------|------|
| MDZ C8190 | 1500 | 32 | 25 | Single | 72 | 65 | 100 | 100 | 1532 | 1525 |
| MDZ C8190 | 1000 | 32 | 25 | Single | 72 | 65 | 100 | 100 | 1032 | 1025 |
| MDZ C8190 | 800 | 32 | 25 | Single | 72 | 65 | 100 | 100 | 832 | 825 |
| MDZ C8190 | 600 | 32 | 25 | Single | 72 | 65 | 100 | 100 | 632 | 625 |
| MDZ C8190 | 400 | 32 | 25 | Single | 72 | 65 | 100 | 100 | 432 | 425 |

NOTE:
Special sizes available on request



HOW TO SPECIFY

Product No. / Fixing Centres / Tube Diameter / Finish / Fixing (refer diagram below)

eg: B8190 / 1000 / 32 / SSS / TM

B = BACK TO BACK FIX

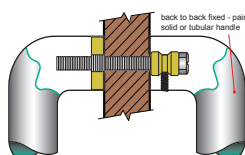

D = DISK FIX

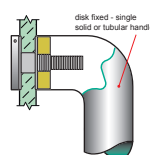

C = CONCEALED FIX

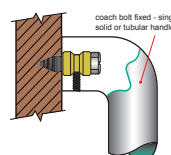

PLEASE SPECIFY DOOR TYPE

GD - Glass doors

TM - Timber doors

AL - Aluminium doors

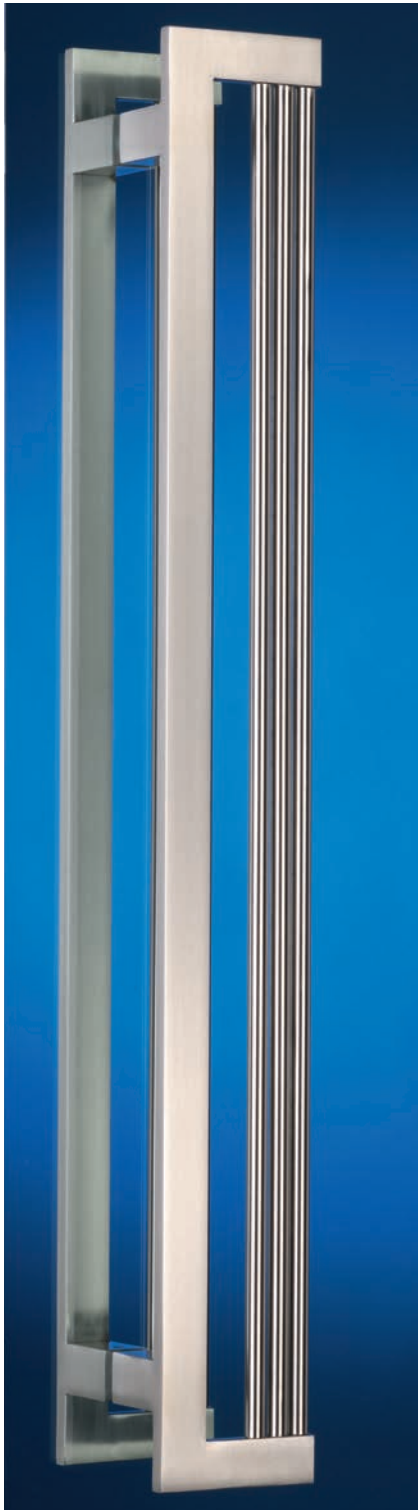

| Product No. | Fixing Centres mm | Rod Diameter mm | Unit | Projection mm | Width mm | Overall Length mm |
|-------------------------|-------------------|-----------------|--------|---------------|----------|-------------------|
| Back to Back Fix | | | | | | |
| MDZ B8200 | 400 | 10 | Pair | 50 | 110 | 500 |
| Disk Fix | | | | | | |
| MDZ D8200 | 400 | 10 | Single | 50 | 110 | 500 |
| Concealed Fix | | | | | | |
| MDZ C8200 | 400 | 10 | Single | 50 | 110 | 500 |

NOTE:
Flat bar measures 25mm x 10mm

HOW TO SPECIFY

Product No. / Fixing Centres / Rod Diameter / Finish / Fixing (refer diagram below)
eg: B8200 / 400 / 10 / SSS / TM

B = BACK TO BACK FIX

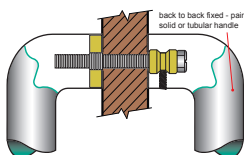

D = DISK FIX

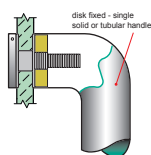

C = CONCEALED FIX

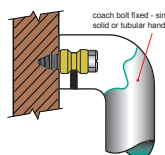

PLEASE SPECIFY DOOR TYPE

- GD** - Glass doors
- TM** - Timber doors
- AL** - Aluminium doors

Entry Door Pull Handle

Material 316 Marine Grade Stainless Steel

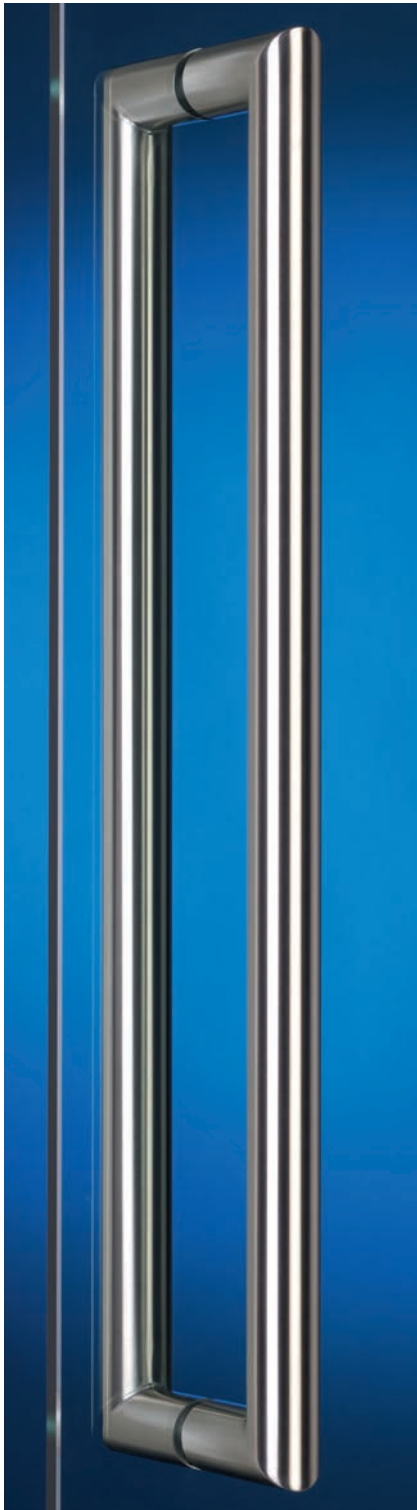

| Product No. | Fixing Centres mm | Tube Diameter mm | | Unit | Projection mm | | Overall Length mm | |
|-------------|-------------------|------------------|--|------|---------------|--|-------------------|--|
|-------------|-------------------|------------------|--|------|---------------|--|-------------------|--|

Back to Back Fix

| | | | | | | | | |
|------------------|------|----|----|------|----|----|------|------|
| MDZ B8210 | 1500 | 32 | 25 | Pair | 77 | 70 | 1532 | 1525 |
| MDZ B8210 | 1000 | 32 | 25 | Pair | 77 | 70 | 1032 | 1025 |
| MDZ B8210 | 800 | 32 | 25 | Pair | 77 | 70 | 832 | 825 |
| MDZ B8210 | 600 | 32 | 25 | Pair | 77 | 70 | 632 | 625 |
| MDZ B8210 | 400 | 32 | 25 | Pair | 77 | 70 | 432 | 425 |

Disk Fix

| | | | | | | | | |
|------------------|------|----|----|--------|----|----|------|------|
| MDZ D8210 | 1500 | 32 | 25 | Single | 77 | 70 | 1532 | 1525 |
| MDZ D8210 | 1000 | 32 | 25 | Single | 77 | 70 | 1032 | 1025 |
| MDZ D8210 | 800 | 32 | 25 | Single | 77 | 70 | 832 | 825 |
| MDZ D8210 | 600 | 32 | 25 | Single | 77 | 70 | 632 | 625 |
| MDZ D8210 | 400 | 32 | 25 | Single | 77 | 70 | 432 | 425 |

Concealed Fix

| | | | | | | | | |
|------------------|------|----|----|--------|----|----|------|------|
| MDZ C8210 | 1500 | 32 | 25 | Single | 77 | 70 | 1532 | 1525 |
| MDZ C8210 | 1000 | 32 | 25 | Single | 77 | 70 | 1032 | 1025 |
| MDZ C8210 | 800 | 32 | 25 | Single | 77 | 70 | 832 | 825 |
| MDZ C8210 | 600 | 32 | 25 | Single | 77 | 70 | 632 | 625 |
| MDZ C8210 | 400 | 32 | 25 | Single | 77 | 70 | 432 | 425 |

NOTE:
Special sizes available on request



HOW TO SPECIFY

Product No. / Fixing Centres / Tube Diameter / Finish / Fixing (refer diagram below)

eg: B8210 / 600 / 32 / SSS / TM

B = BACK TO BACK FIX

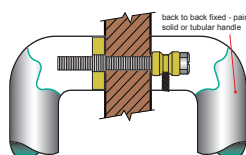

D = DISK FIX

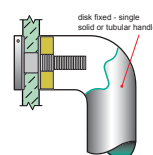

C = CONCEALED FIX

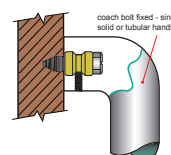

PLEASE SPECIFY DOOR TYPE

GD - Glass doors

TM - Timber doors

AL - Aluminium doors



| Product No. | Fixing Centres mm | Tube Diameter mm | Unit | Projection mm | Width mm | Overall Length mm |
|-------------------------|-------------------|------------------|--------|---------------|----------|-------------------|
| Back to Back Fix | | | | | | |
| MDZ B8220 | 600 | 25 | Pair | 65 | 175 | 632 |
| Disk Fix | | | | | | |
| MDZ D8220 | 600 | 25 | Single | 65 | 175 | 632 |
| Concealed Fix | | | | | | |
| MDZ C8220 | 600 | 25 | Single | 65 | 175 | 632 |

Entry Door Pull Handle

Material 316 Marine Grade Stainless Steel

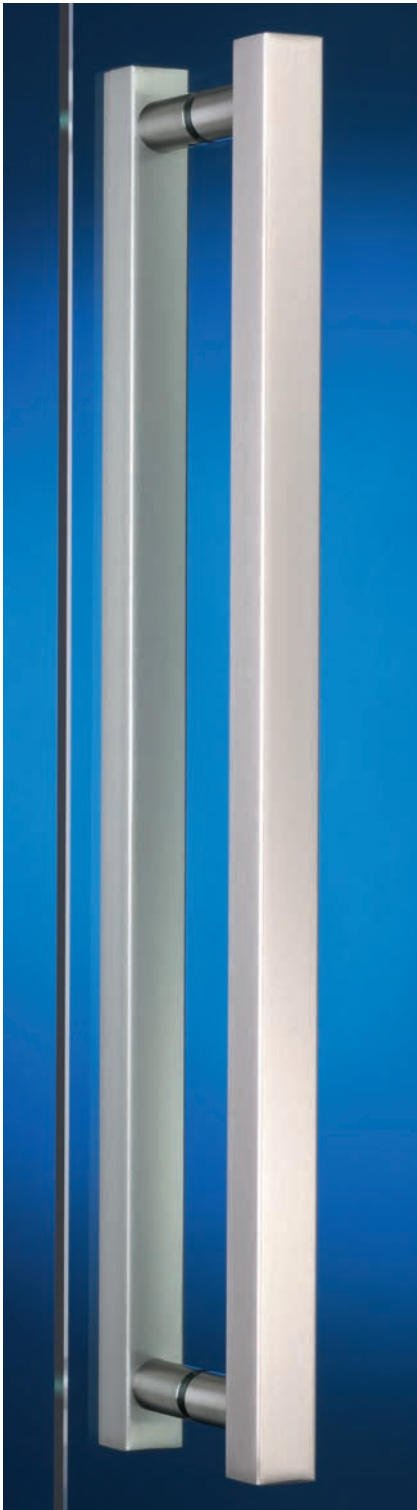

| Product No. | Fixing Centres mm | Square Tube mm | Round Standoff Dia. mm | Unit | Projection mm | Overall Length mm |
|-------------|-------------------|----------------|------------------------|------|---------------|-------------------|
|-------------|-------------------|----------------|------------------------|------|---------------|-------------------|

Back to Back Fix

| | | | | | | | | | |
|------------------|------|----|----|----|----|------|----|----|------|
| MDZ B8230 | 1940 | 32 | 25 | 25 | 19 | Pair | 76 | 69 | 2000 |
| MDZ B8230 | 1440 | 32 | 25 | 25 | 19 | Pair | 76 | 69 | 1500 |
| MDZ B8230 | 940 | 32 | 25 | 25 | 19 | Pair | 76 | 69 | 1000 |
| MDZ B8230 | 740 | 32 | 25 | 25 | 19 | Pair | 76 | 69 | 800 |
| MDZ B8230 | 540 | 32 | 25 | 25 | 19 | Pair | 76 | 69 | 600 |
| MDZ B8230 | 340 | 32 | 25 | 25 | 19 | Pair | 76 | 69 | 400 |

Disk Fix

| | | | | | | | | | |
|------------------|------|----|----|----|----|--------|----|----|------|
| MDZ D8230 | 1940 | 32 | 25 | 25 | 19 | Single | 76 | 69 | 2000 |
| MDZ D8230 | 1440 | 32 | 25 | 25 | 19 | Single | 76 | 69 | 1500 |
| MDZ D8230 | 940 | 32 | 25 | 25 | 19 | Single | 76 | 69 | 1000 |
| MDZ D8230 | 740 | 32 | 25 | 25 | 19 | Single | 76 | 69 | 800 |
| MDZ D8230 | 540 | 32 | 25 | 25 | 19 | Single | 76 | 69 | 600 |
| MDZ D8230 | 340 | 32 | 25 | 25 | 19 | Single | 76 | 69 | 400 |

Concealed Fix

| | | | | | | | | | |
|------------------|------|----|----|----|----|--------|----|----|------|
| MDZ C8230 | 1940 | 32 | 25 | 25 | 19 | Single | 76 | 69 | 2000 |
| MDZ C8230 | 1440 | 32 | 25 | 25 | 19 | Single | 76 | 69 | 1500 |
| MDZ C8230 | 940 | 32 | 25 | 25 | 19 | Single | 76 | 69 | 1000 |
| MDZ C8230 | 740 | 32 | 25 | 25 | 19 | Single | 76 | 69 | 800 |
| MDZ C8230 | 540 | 32 | 25 | 25 | 19 | Single | 76 | 69 | 600 |
| MDZ C8230 | 340 | 32 | 25 | 25 | 19 | Single | 76 | 69 | 400 |

NOTE:
Special sizes available on request



HOW TO SPECIFY

Product No. / Fixing Centres / Square Tube / Finish / Fixing (refer diagram below)

eg: B8230 / 940 / 25 / SSS / TM

B = BACK TO BACK FIX

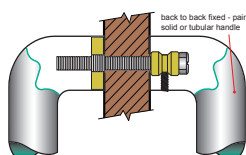

D = DISK FIX

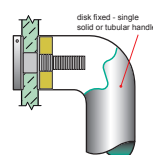

C = CONCEALED FIX

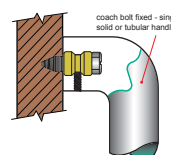

PLEASE SPECIFY DOOR TYPE

- GD** - Glass doors
- TM** - Timber doors
- AL** - Aluminium doors

Entry Door Pull Handle

Material 316 Marine Grade Stainless Steel



| Product No. | Fixing Centres mm | Tube Diameter mm | Unit | Projection mm | Overall Length mm |
|-------------|-------------------|------------------|------|---------------|-------------------|
|-------------|-------------------|------------------|------|---------------|-------------------|

Back to Back Fix

| | | | | | | | |
|------------------|------|----|----|------|----|----|------|
| MDZ B8240 | 1870 | 32 | 25 | Pair | 80 | 74 | 2016 |
| MDZ B8240 | 1370 | 32 | 25 | Pair | 80 | 74 | 1516 |
| MDZ B8240 | 870 | 32 | 25 | Pair | 80 | 74 | 1016 |
| MDZ B8240 | 670 | 32 | 25 | Pair | 80 | 74 | 816 |
| MDZ B8240 | 470 | 32 | 25 | Pair | 80 | 74 | 616 |
| MDZ B8240 | 270 | 32 | 25 | Pair | 80 | 74 | 416 |

Disk Fix

| | | | | | | | |
|------------------|------|----|----|--------|----|----|------|
| MDZ D8240 | 1870 | 32 | 25 | Single | 80 | 74 | 2016 |
| MDZ D8240 | 1370 | 32 | 25 | Single | 80 | 74 | 1516 |
| MDZ D8240 | 870 | 32 | 25 | Single | 80 | 74 | 1016 |
| MDZ D8240 | 670 | 32 | 25 | Single | 80 | 74 | 816 |
| MDZ D8240 | 470 | 32 | 25 | Single | 80 | 74 | 616 |
| MDZ D8240 | 270 | 32 | 25 | Single | 80 | 74 | 416 |

Concealed Fix

| | | | | | | | |
|------------------|------|----|----|--------|----|----|------|
| MDZ C8240 | 1870 | 32 | 25 | Single | 80 | 74 | 2016 |
| MDZ C8240 | 1370 | 32 | 25 | Single | 80 | 74 | 1516 |
| MDZ C8240 | 870 | 32 | 25 | Single | 80 | 74 | 1016 |
| MDZ C8240 | 670 | 32 | 25 | Single | 80 | 74 | 816 |
| MDZ C8240 | 470 | 32 | 25 | Single | 80 | 74 | 616 |
| MDZ C8240 | 270 | 32 | 25 | Single | 80 | 74 | 416 |

NOTE:
Special sizes available on request



HOW TO SPECIFY

Product No. / Fixing Centres / Tube Diameter / Finish / Fixing (refer diagram below)

eg: B8240 / 870 / 25 / SSS / TM

B = BACK TO BACK FIX

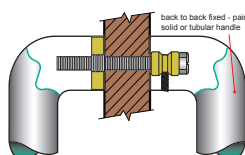

D = DISK FIX

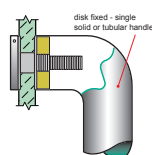

C = CONCEALED FIX

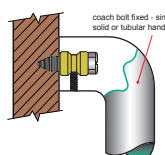

PLEASE SPECIFY DOOR TYPE

GD - Glass doors

TM - Timber doors

AL - Aluminium doors

Entry Door Pull Handle

Material 316 Marine Grade Stainless Steel

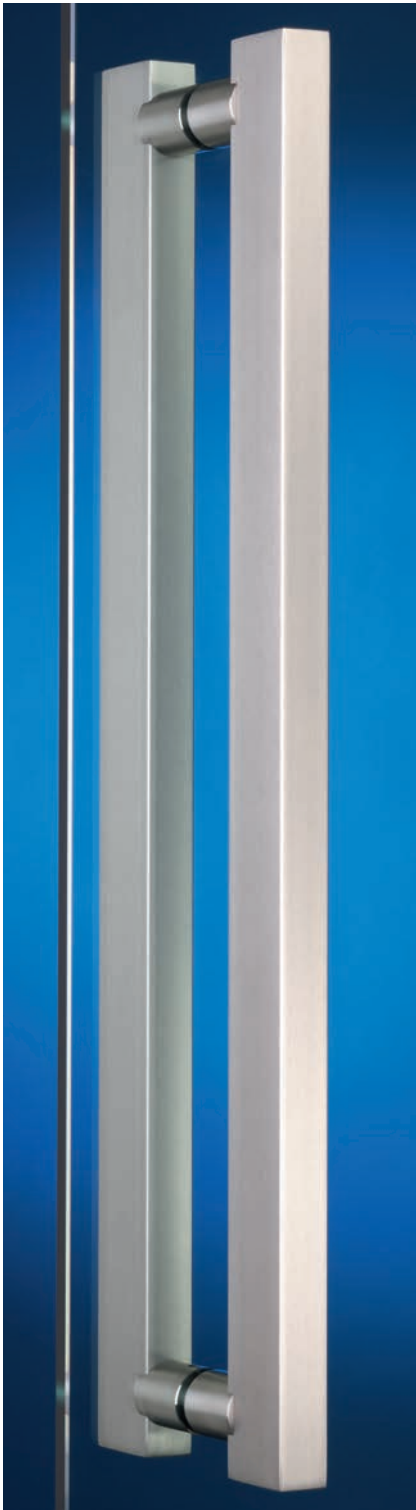

| Product No. | Fixing Centres mm | Section Tube mm | Unit | Projection mm | Overall Length mm |
|-------------|-------------------|-----------------|------|---------------|-------------------|
|-------------|-------------------|-----------------|------|---------------|-------------------|

Back to Back Fix

| | | | | | |
|-----------|------|-------|------|----|------|
| MDZ B8250 | 1940 | 25x50 | Pair | 85 | 2000 |
| MDZ B8250 | 1440 | 25x50 | Pair | 85 | 1500 |
| MDZ B8250 | 940 | 25x50 | Pair | 85 | 1000 |
| MDZ B8250 | 740 | 25x50 | Pair | 85 | 800 |
| MDZ B8250 | 540 | 25x50 | Pair | 85 | 600 |
| MDZ B8250 | 340 | 25x50 | Pair | 85 | 400 |

Disk Fix

| | | | | | |
|-----------|------|-------|--------|----|------|
| MDZ D8250 | 1940 | 25x50 | Single | 85 | 2000 |
| MDZ D8250 | 1440 | 25x50 | Single | 85 | 1500 |
| MDZ D8250 | 940 | 25x50 | Single | 85 | 1000 |
| MDZ D8250 | 740 | 25x50 | Single | 85 | 800 |
| MDZ D8250 | 540 | 25x50 | Single | 85 | 600 |
| MDZ D8250 | 340 | 25x50 | Single | 85 | 400 |

Concealed Fix

| | | | | | |
|-----------|------|-------|--------|----|------|
| MDZ C8250 | 1940 | 25x50 | Single | 85 | 2000 |
| MDZ C8250 | 1440 | 25x50 | Single | 85 | 1500 |
| MDZ C8250 | 940 | 25x50 | Single | 85 | 1000 |
| MDZ C8250 | 740 | 25x50 | Single | 85 | 800 |
| MDZ C8250 | 540 | 25x50 | Single | 85 | 600 |
| MDZ C8250 | 340 | 25x50 | Single | 85 | 400 |

NOTE:
Special sizes available on request



HOW TO SPECIFY

Product No. / Fixing Centres / Section Tube / Finish / Fixing (refer diagram below)

eg: B8250 / 940 / 25x50 / SSS / TM

B = BACK TO BACK FIX

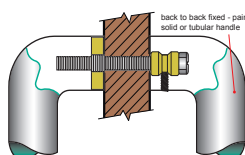

D = DISK FIX

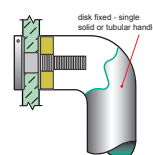

C = CONCEALED FIX

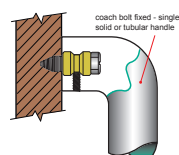

PLEASE SPECIFY DOOR TYPE

GD - Glass doors

TM - Timber doors

AL - Aluminium doors

Entry Door Pull Handle

Material 316 Marine Grade Stainless Steel



| Product No. | Fixing Centres mm | Tube Diameter mm | Unit | Projection mm | Overall Length mm |
|-------------|-------------------|------------------|------|---------------|-------------------|
|-------------|-------------------|------------------|------|---------------|-------------------|

Back to Back Fix

| | | | | | |
|-----------|------|----|------|----|------|
| MDZ B8260 | 1900 | 38 | Pair | 95 | 2000 |
| MDZ B8260 | 1400 | 38 | Pair | 95 | 1500 |
| MDZ B8260 | 900 | 38 | Pair | 95 | 1000 |
| MDZ B8260 | 700 | 38 | Pair | 95 | 800 |
| MDZ B8260 | 600 | 38 | Pair | 95 | 700 |
| MDZ B8260 | 400 | 38 | Pair | 95 | 500 |

Disk Fix

| | | | | | |
|-----------|------|----|--------|----|------|
| MDZ D8260 | 1900 | 38 | Single | 95 | 2000 |
| MDZ D8260 | 1400 | 38 | Single | 95 | 1500 |
| MDZ D8260 | 900 | 38 | Single | 95 | 1000 |
| MDZ D8260 | 700 | 38 | Single | 95 | 800 |
| MDZ D8260 | 600 | 38 | Single | 95 | 700 |
| MDZ D8260 | 400 | 38 | Single | 95 | 500 |

Concealed Fix

| | | | | | |
|-----------|------|----|--------|----|------|
| MDZ C8260 | 1900 | 38 | Single | 95 | 2000 |
| MDZ C8260 | 1400 | 38 | Single | 95 | 1500 |
| MDZ C8260 | 900 | 38 | Single | 95 | 1000 |
| MDZ C8260 | 700 | 38 | Single | 95 | 800 |
| MDZ C8260 | 600 | 38 | Single | 95 | 700 |
| MDZ C8260 | 400 | 38 | Single | 95 | 500 |

NOTE:
Square legs measure 32mm x 32mm
Special sizes available on request



HOW TO SPECIFY

Product No. / Fixing Centres / Tube Diameter / Finish / Fixing (refer diagram below)

eg: B8260 / 1900 / 38 / SSS / TM

B = BACK TO BACK FIX

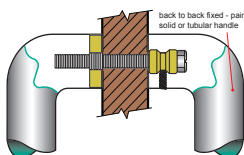

D = DISK FIX

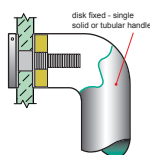

C = CONCEALED FIX

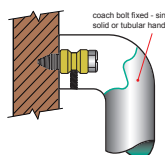

PLEASE SPECIFY DOOR TYPE

GD - Glass doors

TM - Timber doors

AL - Aluminium doors

Entry Door Pull Handle

Material 316 Marine Grade Stainless Steel



| Product No. | Fixing Centres mm | Tube Diameter mm | Unit | Projection mm | Overall Length mm |
|-------------|-------------------|------------------|------|---------------|-------------------|
|-------------|-------------------|------------------|------|---------------|-------------------|

Back to Back Fix

| | | | | | |
|-----------|------|----|------|----|------|
| MDZ B8270 | 1900 | 38 | Pair | 83 | 2000 |
| MDZ B8270 | 1400 | 38 | Pair | 83 | 1500 |
| MDZ B8270 | 900 | 38 | Pair | 83 | 1000 |
| MDZ B8270 | 700 | 38 | Pair | 83 | 800 |
| MDZ B8270 | 600 | 38 | Pair | 83 | 700 |
| MDZ B8270 | 400 | 38 | Pair | 83 | 500 |

Disk Fix

| | | | | | |
|-----------|------|----|--------|----|------|
| MDZ D8270 | 1900 | 38 | Single | 83 | 2000 |
| MDZ D8270 | 1400 | 38 | Single | 83 | 1500 |
| MDZ D8270 | 900 | 38 | Single | 83 | 1000 |
| MDZ D8270 | 700 | 38 | Single | 83 | 800 |
| MDZ D8270 | 600 | 38 | Single | 83 | 700 |
| MDZ D8270 | 400 | 38 | Single | 83 | 500 |

Concealed Fix

| | | | | | |
|-----------|------|----|--------|----|------|
| MDZ C8270 | 1900 | 38 | Single | 83 | 2000 |
| MDZ C8270 | 1400 | 38 | Single | 83 | 1500 |
| MDZ C8270 | 900 | 38 | Single | 83 | 1000 |
| MDZ C8270 | 700 | 38 | Single | 83 | 800 |
| MDZ C8270 | 600 | 38 | Single | 83 | 700 |
| MDZ C8270 | 400 | 38 | Single | 83 | 500 |

NOTE:
Special sizes available on request



HOW TO SPECIFY

Product No. / Fixing Centres / Tube Diameter / Finish / Fixing (refer diagram below)

eg: B8270 / 900 / 38 / SSS / TM

B = BACK TO BACK FIX

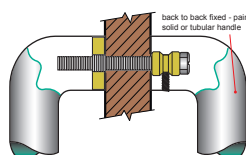

D = DISK FIX

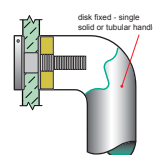

C = CONCEALED FIX

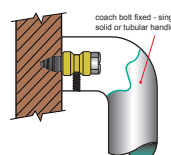

PLEASE SPECIFY DOOR TYPE

- GD** - Glass doors
- TM** - Timber doors
- AL** - Aluminium doors

Entry Door Pull Handle

Material 316 Marine Grade Stainless Steel

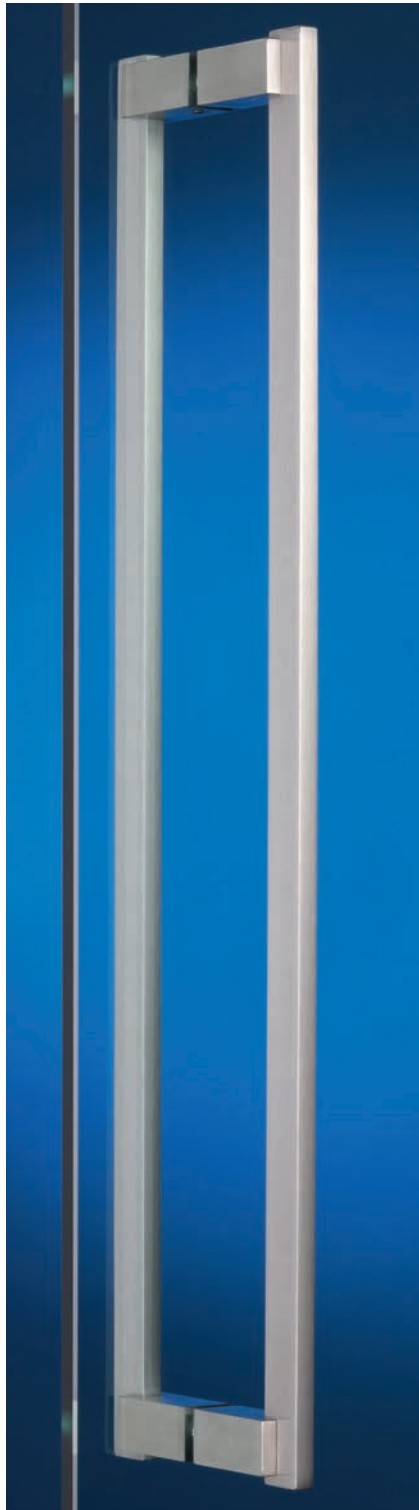

| Product No. | Fixing Centres mm | Rectangle Section mm | Unit | Projection mm | Overall Length mm |
|-------------|-------------------|----------------------|------|---------------|-------------------|
|-------------|-------------------|----------------------|------|---------------|-------------------|

Back to Back Fix

| | | | | | |
|------------------|------|-------|------|----|------|
| MDZ B8280 | 1000 | 25x10 | Pair | 70 | 1035 |
| MDZ B8280 | 800 | 25x10 | Pair | 70 | 835 |
| MDZ B8280 | 600 | 25x10 | Pair | 70 | 635 |
| MDZ B8280 | 400 | 25x10 | Pair | 70 | 435 |

Disk Fix

| | | | | | |
|------------------|------|-------|--------|----|------|
| MDZ D8280 | 1000 | 25x10 | Single | 70 | 1035 |
| MDZ D8280 | 800 | 25x10 | Single | 70 | 835 |
| MDZ D8280 | 600 | 25x10 | Single | 70 | 635 |
| MDZ D8280 | 400 | 25x10 | Single | 70 | 435 |

Concealed Fix

| | | | | | |
|------------------|------|-------|--------|----|------|
| MDZ C8280 | 1000 | 25x10 | Single | 70 | 1035 |
| MDZ C8280 | 800 | 25x10 | Single | 70 | 835 |
| MDZ C8280 | 600 | 25x10 | Single | 70 | 635 |
| MDZ C8280 | 400 | 25x10 | Single | 70 | 435 |

NOTE:
Square legs measure 25mm x 25mm
Special sizes available on request



HOW TO SPECIFY

Product No. / Fixing Centres / Rectangular Section / Finish / Fixing (refer diagram below)

eg: B8280 / 1000 / 25x10 / SSS / TM

B = BACK TO BACK FIX

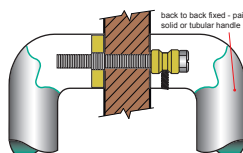

D = DISK FIX

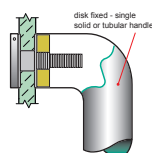

C = CONCEALED FIX

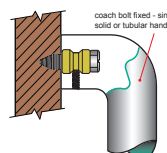

PLEASE SPECIFY DOOR TYPE

GD - Glass doors

TM - Timber doors

AL - Aluminium doors

Entry Door Pull Handle

Material 316 Marine Grade Stainless Steel



| Product No. | Fixing Centres mm | Rail Section mm | Standoff mm | Unit | Projection mm | Overall Length mm |
|-------------|-------------------|-----------------|-------------|------|---------------|-------------------|
|-------------|-------------------|-----------------|-------------|------|---------------|-------------------|

Back to Back Fix

| | | | | | | |
|------------------|-----|-------|-------|------|----|-----|
| MDZ B8330 | 775 | 50x10 | 50x25 | Pair | 50 | 800 |
| MDZ B8330 | 575 | 50x10 | 50x25 | Pair | 50 | 600 |
| MDZ B8330 | 375 | 50x10 | 50x25 | Pair | 50 | 400 |

Disk Fix

| | | | | | | |
|------------------|-----|-------|-------|--------|----|-----|
| MDZ D8330 | 775 | 50x10 | 50x25 | Single | 50 | 800 |
| MDZ D8330 | 575 | 50x10 | 50x25 | Single | 50 | 600 |
| MDZ D8330 | 375 | 50x10 | 50x25 | Single | 50 | 400 |

Concealed Fix

| | | | | | | |
|------------------|-----|-------|-------|--------|----|-----|
| MDZ C8330 | 775 | 50x10 | 50x25 | Single | 50 | 800 |
| MDZ C8330 | 575 | 50x10 | 50x25 | Single | 50 | 600 |
| MDZ C8330 | 375 | 50x10 | 50x25 | Single | 50 | 400 |

NOTE:
Special sizes available on request



HOW TO SPECIFY

Product No. / Fixing Centres / Rail Section / Finish / Fixing (refer diagram below)
eg: B8330 / 575 / 50x10 / SSS / TM

B = BACK TO BACK FIX

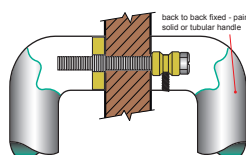

D = DISK FIX

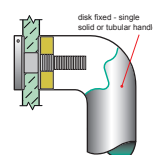

C = CONCEALED FIX

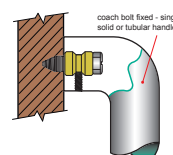

PLEASE SPECIFY DOOR TYPE

- GD** - Glass doors
- TM** - Timber doors
- AL** - Aluminium doors

Entry Door Pull Handle

Material 316 Marine Grade Stainless Steel



| Product No. | Diameter mm | Projection mm | Length mm | Fixing Centres mm |
|-------------|-------------|---------------|-----------|-------------------|
| MDZ 8340/A | 32 | 77 | 2400 | 2240 |
| MDZ 8340/B | 32 | 77 | 2300 | 2140 |
| MDZ 8340/C | 32 | 77 | 2200 | 2040 |
| MDZ 8340/D | 32 | 77 | 2100 | 1940 |
| MDZ 8340/E | 32 | 77 | 2000 | 1840 |
| MDZ 8340/F | 32 | 77 | 1900 | 1740 |
| MDZ 8340/G | 32 | 77 | 1800 | 1640 |
| MDZ 8340/H | 32 | 77 | 1700 | 1540 |
| MDZ 8340/I | 32 | 77 | 1600 | 1440 |
| MDZ 8340/J | 32 | 77 | 1500 | 1340 |
| MDZ 8340/K | 32 | 77 | 1400 | 1240 |
| MDZ 8340/L | 32 | 77 | 1300 | 1140 |
| MDZ 8340/M | 32 | 77 | 1200 | 1040 |
| MDZ 8340/N | 32 | 77 | 1100 | 940 |
| MDZ 8340/O | 32 | 77 | 1000 | 840 |
| MDZ 8340/P | 32 | 77 | 900 | 740 |
| MDZ 8340/Q | 32 | 77 | 800 | 640 |
| MDZ 8340/R | 32 | 77 | 700 | 540 |
| MDZ 8340/S | 32 | 77 | 600 | 440 |
| MDZ 8340/T | 32 | 77 | 500 | 340 |
| MDZ 8340/U | 32 | 77 | 400 | 240 |

NOTE:
Special sizes available on request



HOW TO SPECIFY

Product No. / Diameter / Projection / Finish / Fixing (refer diagram below)

eg: B8340A / 32 / 77 / SSS / TM

B = BACK TO BACK FIX

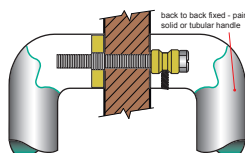

D = DISK FIX

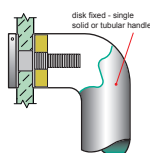

C = CONCEALED FIX

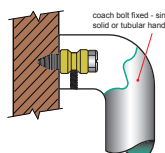

PLEASE SPECIFY DOOR TYPE

GD - Glass doors

TM - Timber doors

AL - Aluminium doors

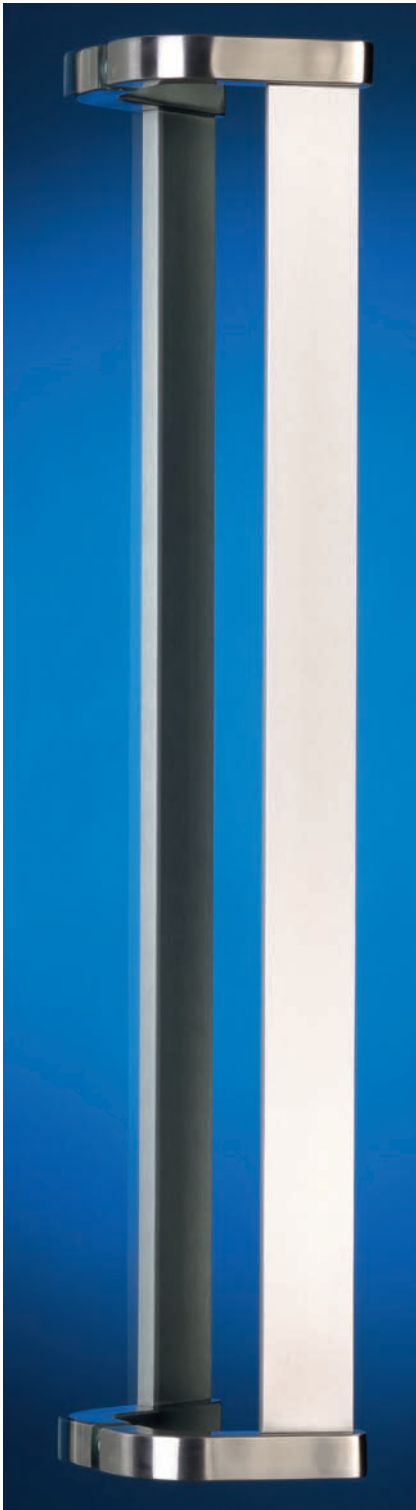

| Product No. | Fixing Centres mm | Rail Section mm | Unit | Projection mm | Width mm | Overall Length mm |
|-------------|-------------------|-----------------|------|---------------|----------|-------------------|
|-------------|-------------------|-----------------|------|---------------|----------|-------------------|

Back to Back Fix

| | | | | | | |
|-----------|------|-------|------|----|----|------|
| MDZ B8350 | 1500 | 40x10 | Pair | 72 | 95 | 1519 |
| MDZ B8350 | 1000 | 40x10 | Pair | 72 | 95 | 1019 |
| MDZ B8350 | 800 | 40x10 | Pair | 72 | 95 | 819 |
| MDZ B8350 | 600 | 40x10 | Pair | 72 | 95 | 619 |
| MDZ B8350 | 400 | 40x10 | Pair | 72 | 95 | 419 |
| MDZ B8350 | 200 | 40x10 | Pair | 72 | 95 | 219 |

Disk Fix

| | | | | | | |
|-----------|------|-------|--------|----|----|------|
| MDZ D8350 | 1500 | 40x10 | Single | 72 | 95 | 1519 |
| MDZ D8350 | 1000 | 40x10 | Single | 72 | 95 | 1019 |
| MDZ D8350 | 800 | 40x10 | Single | 72 | 95 | 819 |
| MDZ D8350 | 600 | 40x10 | Single | 72 | 95 | 619 |
| MDZ D8350 | 400 | 40x10 | Single | 72 | 95 | 419 |
| MDZ D8350 | 200 | 40x10 | Single | 72 | 95 | 219 |

Concealed Fix

| | | | | | | |
|-----------|------|-------|--------|----|----|------|
| MDZ C8350 | 1500 | 40x10 | Single | 72 | 95 | 1519 |
| MDZ C8350 | 1000 | 40x10 | Single | 72 | 95 | 1019 |
| MDZ C8350 | 800 | 40x10 | Single | 72 | 95 | 819 |
| MDZ C8350 | 600 | 40x10 | Single | 72 | 95 | 619 |
| MDZ C8350 | 400 | 40x10 | Single | 72 | 95 | 419 |
| MDZ C8350 | 200 | 40x10 | Single | 72 | 95 | 219 |

HOW TO SPECIFY

Product No. / Fixing Centres / Rail Section / Finish / Fixing (refer diagram below)

eg: B8350 / 800 / 40x10 / SSS / TM

B = BACK TO BACK FIX

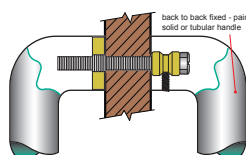

back to back fixed - pair solid or tubular handle

D = DISK FIX

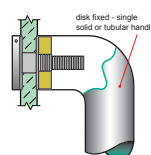

disk fixed - single solid or tubular handle

C = CONCEALED FIX

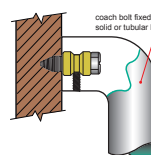

coach bolt fixed - single solid or tubular handle

PLEASE SPECIFY DOOR TYPE

GD - Glass doors

TM - Timber doors

AL - Aluminium doors

Entry Door Pull Handle

Material 316 Marine Grade Stainless Steel

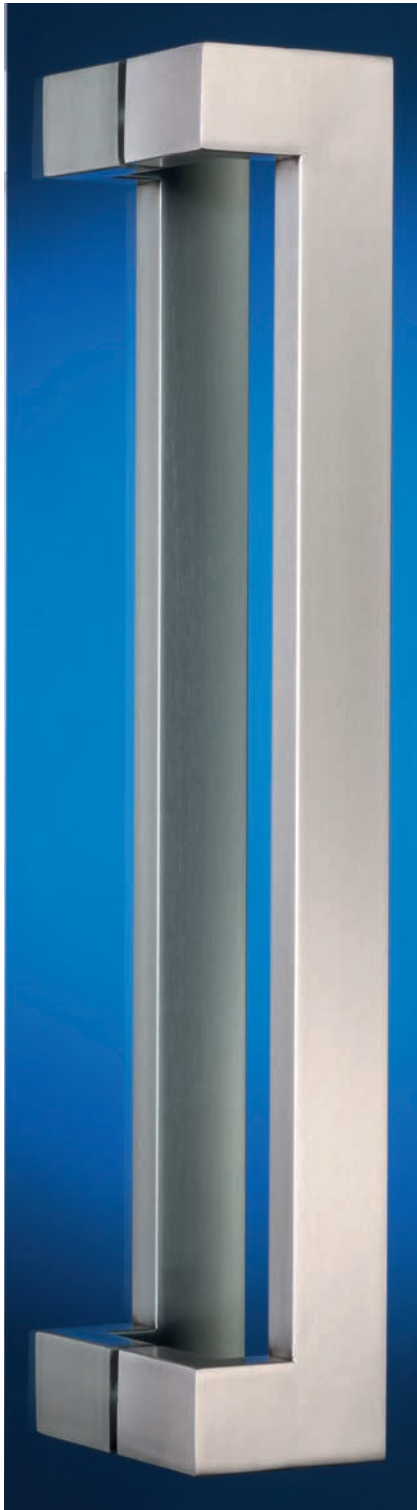

| Product No. | Section mm | Projection mm | Length mm | Fixing Centres mm |
|-------------|------------|---------------|-----------|-------------------|
| MDZ 8360/E | 50x25 | 70 | 2250 | 2000 |
| MDZ 8360/F | 50x25 | 70 | 1925 | 1900 |
| MDZ 8360/G | 50x25 | 70 | 1825 | 1800 |
| MDZ 8360/H | 50x25 | 70 | 1725 | 1700 |
| MDZ 8360/I | 50x25 | 70 | 1625 | 1600 |
| MDZ 8360/J | 50x25 | 70 | 1525 | 1500 |
| MDZ 8360/K | 50x25 | 70 | 1425 | 1400 |
| MDZ 8360/L | 50x25 | 70 | 1325 | 1300 |
| MDZ 8360/M | 50x25 | 70 | 1225 | 1200 |
| MDZ 8360/N | 50x25 | 70 | 1125 | 1100 |
| MDZ 8360/O | 50x25 | 70 | 1025 | 1000 |
| MDZ 8360/P | 50x25 | 70 | 925 | 900 |
| MDZ 8360/Q | 50x25 | 70 | 825 | 800 |
| MDZ 8360/R | 50x25 | 70 | 725 | 700 |
| MDZ 8360/S | 50x25 | 70 | 625 | 600 |
| MDZ 8360/T | 50x25 | 70 | 525 | 500 |
| MDZ 8360/U | 50x25 | 70 | 425 | 400 |

NOTE:
Special sizes available on request



HOW TO SPECIFY

Product No. / Section / Projection / Finish / Fixing (refer diagram below)

eg: 8360E / 50x25 / 70 / SSS / TM

B = BACK TO BACK FIX

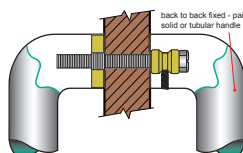

D = DISK FIX

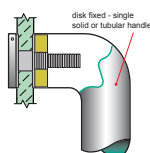

C = CONCEALED FIX

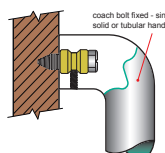

PLEASE SPECIFY DOOR TYPE

GD - Glass doors

TM - Timber doors

AL - Aluminium doors

Entry Door Pull Handle

Material 316 Marine Grade Stainless Steel



| Product No. | Fixing Centres mm | Rail Section mm | Unit | Projection mm | Width mm | Overall Length mm |
|-------------------------|-------------------|-----------------|--------|---------------|----------|-------------------|
| Back to Back Fix | | | | | | |
| MDZ B8370 | 600 | 25x25 | Pair | 65 | 100 | 625 |
| Disk Fix | | | | | | |
| MDZ D8370 | 600 | 25x25 | Single | 65 | 100 | 625 |
| Concealed Fix | | | | | | |
| MDZ C8370 | 600 | 25x25 | Single | 65 | 100 | 625 |



HOW TO SPECIFY

Product No. / Fixing Centres / Rail Section / Finish / Fixing (refer diagram below)
eg: B8370 / 600 / 25x25 / SSS / TM

B = BACK TO BACK FIX

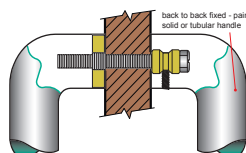

D = DISK FIX

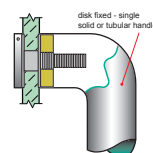

C = CONCEALED FIX

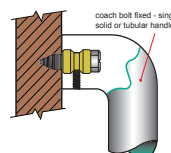

PLEASE SPECIFY DOOR TYPE

GD - Glass doors

TM - Timber doors

AL - Aluminium doors

Entry Door Pull Handle

Material 316 Marine Grade Stainless Steel



| Product No. | Fixing Centres mm | Rail Section mm | Unit | Projection mm | Overall Length mm |
|-------------------------|-------------------|-----------------|--------|---------------|-------------------|
| Back to Back Fix | | | | | |
| MDZ B8380 | 600 | 25x25 | Pair | 95 | 625 |
| Disk Fix | | | | | |
| MDZ D8380 | 600 | 25x25 | Single | 95 | 625 |
| Concealed Fix | | | | | |
| MDZ C8380 | 600 | 25x25 | Single | 95 | 625 |

HOW TO SPECIFY

Product No. / Fixing Centres / Rail Section / Finish / Fixing (refer diagram below)

eg: B8380 / 600 / 25x25 / SSS / TM

B = BACK TO BACK FIX

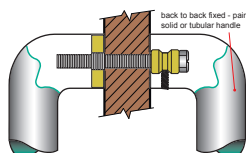

D = DISK FIX

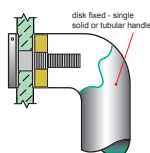

C = CONCEALED FIX

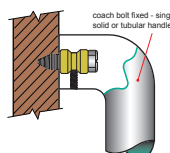

PLEASE SPECIFY DOOR TYPE

GD - Glass doors

TM - Timber doors

AL - Aluminium doors

Entry Door Pull Handle

Material 316 Marine Grade Stainless Steel



| Product No. | Fixing Centres mm | Tube Diameter mm | Unit | Projection mm | Width mm | Overall Length mm |
|-------------|-------------------|------------------|------|---------------|----------|-------------------|
|-------------|-------------------|------------------|------|---------------|----------|-------------------|

Back to Back Fix

| | | | | | | | | | | |
|-----------|------|----|----|------|----|----|-----|-----|------|------|
| MDZ B8390 | 1500 | 32 | 25 | Pair | 77 | 70 | 115 | 110 | 1532 | 1525 |
| MDZ B8390 | 1000 | 32 | 25 | Pair | 77 | 70 | 115 | 110 | 1032 | 1025 |
| MDZ B8390 | 800 | 32 | 25 | Pair | 77 | 70 | 115 | 110 | 832 | 825 |
| MDZ B8390 | 600 | 32 | 25 | Pair | 77 | 70 | 115 | 110 | 632 | 625 |
| MDZ B8390 | 400 | 32 | 25 | Pair | 77 | 70 | 115 | 110 | 432 | 425 |

Disk Fix

| | | | | | | | | | | |
|-----------|------|----|----|--------|----|----|-----|-----|------|------|
| MDZ D8390 | 1500 | 32 | 25 | Single | 77 | 70 | 115 | 110 | 1532 | 1525 |
| MDZ D8390 | 1000 | 32 | 25 | Single | 77 | 70 | 115 | 110 | 1032 | 1025 |
| MDZ D8390 | 800 | 32 | 25 | Single | 77 | 70 | 115 | 110 | 832 | 825 |
| MDZ D8390 | 600 | 32 | 25 | Single | 77 | 70 | 115 | 110 | 632 | 625 |
| MDZ D8390 | 400 | 32 | 25 | Single | 77 | 70 | 115 | 110 | 432 | 425 |

Concealed Fix

| | | | | | | | | | | |
|-----------|------|----|----|--------|----|----|-----|-----|------|------|
| MDZ C8390 | 1500 | 32 | 25 | Single | 77 | 70 | 115 | 110 | 1532 | 1525 |
| MDZ C8390 | 1000 | 32 | 25 | Single | 77 | 70 | 115 | 110 | 1032 | 1025 |
| MDZ C8390 | 800 | 32 | 25 | Single | 77 | 70 | 115 | 110 | 832 | 825 |
| MDZ C8390 | 600 | 32 | 25 | Single | 77 | 70 | 115 | 110 | 632 | 625 |
| MDZ C8390 | 400 | 32 | 25 | Single | 77 | 70 | 115 | 110 | 432 | 425 |

NOTE:
Special sizes available on request



HOW TO SPECIFY

Product No. / Fixing Centres / Tube Diameter / Finish / Fixing (refer diagram below)

eg: B8390 / 800 / 25 / SSS / TM

B = BACK TO BACK FIX

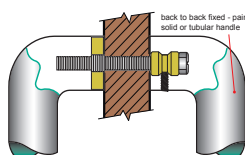

D = DISK FIX

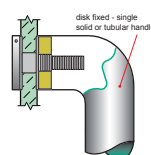

C = CONCEALED FIX

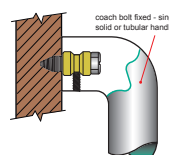

PLEASE SPECIFY DOOR TYPE

GD - Glass doors

TM - Timber doors

AL - Aluminium doors

Entry Door Pull Handle

Material 316 Marine Grade Stainless Steel



| Product No. | Diameter mm | | Projection mm | | Width mm | | Length mm | Fixing Centres mm |
|-------------------|-------------|----|---------------|----|----------|----|-----------|-------------------|
| MDZ 8400/A | 32 | 25 | 70 | 65 | 100 | 95 | 2400 | 2240 |
| MDZ 8400/B | 32 | 25 | 70 | 65 | 100 | 95 | 2300 | 2140 |
| MDZ 8400/C | 32 | 25 | 70 | 65 | 100 | 95 | 2200 | 2040 |
| MDZ 8400/D | 32 | 25 | 70 | 65 | 100 | 95 | 2100 | 1940 |
| MDZ 8400/E | 32 | 25 | 70 | 65 | 100 | 95 | 2000 | 1840 |
| MDZ 8400/F | 32 | 25 | 70 | 65 | 100 | 95 | 1900 | 1740 |
| MDZ 8400/G | 32 | 25 | 70 | 65 | 100 | 95 | 1800 | 1640 |
| MDZ 8400/H | 32 | 25 | 70 | 65 | 100 | 95 | 1700 | 1540 |
| MDZ 8400/I | 32 | 25 | 70 | 65 | 100 | 95 | 1600 | 1440 |
| MDZ 8400/J | 32 | 25 | 70 | 65 | 100 | 95 | 1500 | 1340 |
| MDZ 8400/K | 32 | 25 | 70 | 65 | 100 | 95 | 1400 | 1240 |
| MDZ 8400/L | 32 | 25 | 70 | 65 | 100 | 95 | 1300 | 1140 |
| MDZ 8400/M | 32 | 25 | 70 | 65 | 100 | 95 | 1200 | 1040 |
| MDZ 8400/N | 32 | 25 | 70 | 65 | 100 | 95 | 1100 | 940 |
| MDZ 8400/O | 32 | 25 | 70 | 65 | 100 | 95 | 1000 | 840 |
| MDZ 8400/P | 32 | 25 | 70 | 65 | 100 | 95 | 900 | 740 |
| MDZ 8400/Q | 32 | 25 | 70 | 65 | 100 | 95 | 800 | 640 |
| MDZ 8400/R | 32 | 25 | 70 | 65 | 100 | 95 | 700 | 540 |
| MDZ 8400/S | 32 | 25 | 70 | 65 | 100 | 95 | 600 | 440 |
| MDZ 8400/T | 32 | 25 | 70 | 65 | 100 | 95 | 500 | 340 |
| MDZ 8400/U | 32 | 25 | 70 | 65 | 100 | 95 | 400 | 240 |

NOTE:
Special sizes available on request



HOW TO SPECIFY

Product No. / Diameter / Projection / Finish / Fixing (refer diagram below)

eg: 8400A / 32 / 70 / SSS / D Fix GD

B = BACK TO BACK FIX

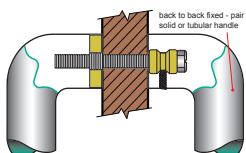

D = DISK FIX

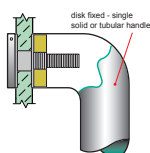

C = CONCEALED FIX

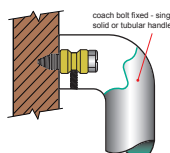

PLEASE SPECIFY DOOR TYPE

GD - Glass doors

TM - Timber doors

AL - Aluminium doors

Entry Door Pull Handle

Material 316 Marine Grade Stainless Steel



| Product No. | Fixing Centres mm | Rail Section mm | Standoff mm | Unit | Projection mm | Overall Length mm |
|-------------|-------------------|-----------------|-------------|------|---------------|-------------------|
|-------------|-------------------|-----------------|-------------|------|---------------|-------------------|

Back to Back Fix

| | | | | | | |
|------------------|------|-------|-------|------|----|------|
| MDZ B8410 | 1500 | 40x10 | 50x25 | Pair | 55 | 1660 |
| MDZ B8410 | 1000 | 40x10 | 50x25 | Pair | 55 | 1160 |
| MDZ B8410 | 800 | 40x10 | 50x25 | Pair | 55 | 960 |
| MDZ B8410 | 600 | 40x10 | 50x25 | Pair | 55 | 760 |
| MDZ B8410 | 400 | 40x10 | 50x25 | Pair | 55 | 560 |

Disk Fix

| | | | | | | |
|------------------|------|-------|-------|--------|----|------|
| MDZ D8410 | 1500 | 40x10 | 50x25 | Single | 55 | 1660 |
| MDZ D8410 | 1000 | 40x10 | 50x25 | Single | 55 | 1160 |
| MDZ D8410 | 800 | 40x10 | 50x25 | Single | 55 | 960 |
| MDZ D8410 | 600 | 40x10 | 50x25 | Single | 55 | 760 |
| MDZ D8410 | 400 | 40x10 | 50x25 | Single | 55 | 560 |

Concealed Fix

| | | | | | | |
|------------------|------|-------|-------|--------|----|------|
| MDZ C8410 | 1500 | 40x10 | 50x25 | Single | 55 | 1660 |
| MDZ C8410 | 1000 | 40x10 | 50x25 | Single | 55 | 1160 |
| MDZ C8410 | 800 | 40x10 | 50x25 | Single | 55 | 960 |
| MDZ C8410 | 600 | 40x10 | 50x25 | Single | 55 | 760 |
| MDZ C8410 | 400 | 40x10 | 50x25 | Single | 55 | 560 |

NOTE:
Special sizes available on request



HOW TO SPECIFY

Product No. / Fixing Centres / Rail Section / Finish / Fixing (refer diagram below)

eg: B8410 / 800 / 40x10 / SSS / TM

B = BACK TO BACK FIX

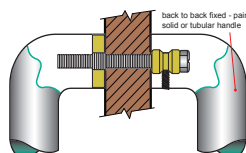

D = DISK FIX

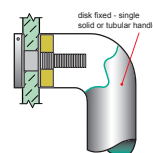

C = CONCEALED FIX

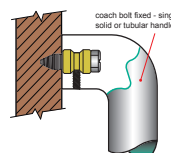

PLEASE SPECIFY DOOR TYPE

GD - Glass doors

TM - Timber doors

AL - Aluminium doors

Entry Door Pull Handle

Material 316 Marine Grade Stainless Steel



| Product No. | Fixing Centres mm | Rail Section mm | Unit | Projection mm | Overall Length mm |
|-------------|-------------------|-----------------|------|---------------|-------------------|
|-------------|-------------------|-----------------|------|---------------|-------------------|

Back to Back Fix

| | | | | | |
|-----------|------|-------|------|----|------|
| MDZ B8420 | 1500 | 40x10 | Pair | 65 | 1660 |
| MDZ B8420 | 1000 | 40x10 | Pair | 65 | 1160 |
| MDZ B8420 | 800 | 40x10 | Pair | 65 | 960 |
| MDZ B8420 | 600 | 40x10 | Pair | 65 | 760 |
| MDZ B8420 | 400 | 40x10 | Pair | 65 | 560 |

Disk Fix

| | | | | | |
|-----------|------|-------|--------|----|------|
| MDZ D8420 | 1500 | 40x10 | Single | 65 | 1660 |
| MDZ D8420 | 1000 | 40x10 | Single | 65 | 1160 |
| MDZ D8420 | 800 | 40x10 | Single | 65 | 960 |
| MDZ D8420 | 600 | 40x10 | Single | 65 | 760 |
| MDZ D8420 | 400 | 40x10 | Single | 65 | 560 |

Concealed Fix

| | | | | | |
|-----------|------|-------|--------|----|------|
| MDZ C8420 | 1500 | 40x10 | Single | 65 | 1660 |
| MDZ C8420 | 1000 | 40x10 | Single | 65 | 1160 |
| MDZ C8420 | 800 | 40x10 | Single | 65 | 960 |
| MDZ C8420 | 600 | 40x10 | Single | 65 | 760 |
| MDZ C8420 | 400 | 40x10 | Single | 65 | 560 |

NOTE:
Special sizes available on request

HOW TO SPECIFY

Product No. / Fixing Centres / Rail Section / Finish / Fixing (refer diagram below)

eg: B8420 / 800 / 40x10 / SSS / TM

B = BACK TO BACK FIX

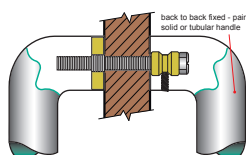

D = DISK FIX

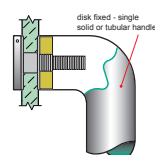

C = CONCEALED FIX

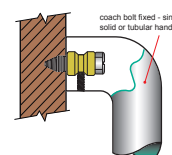

PLEASE SPECIFY DOOR TYPE

GD - Glass doors

TM - Timber doors

AL - Aluminium doors

Entry Door Pull Handle

Material 316 Marine Grade Stainless Steel

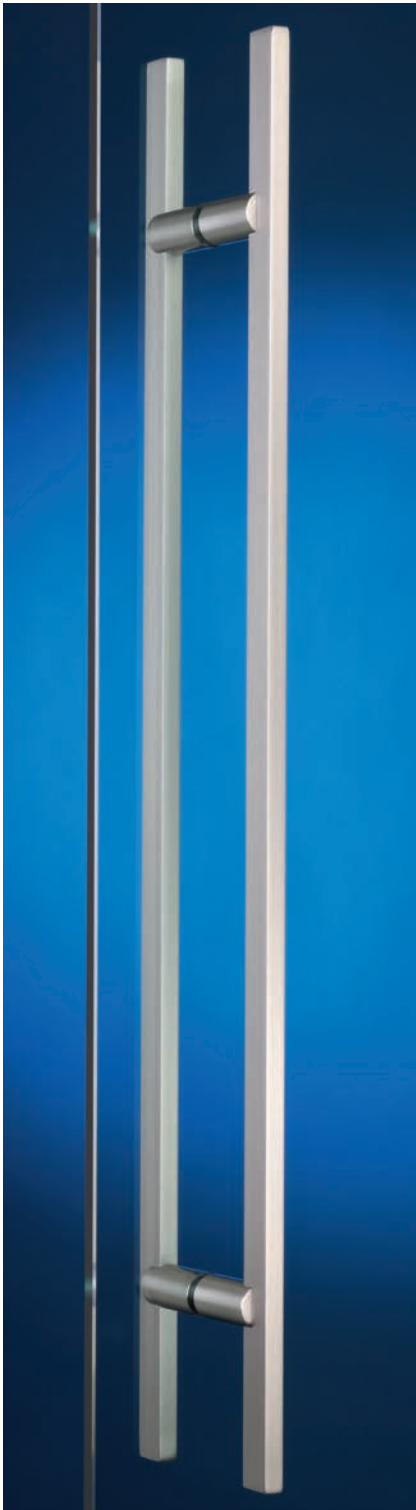

| Product No. | Fixing Centres mm | Rail Section mm | Unit | Projection mm | Overall Length mm |
|-------------|-------------------|-----------------|------|---------------|-------------------|
|-------------|-------------------|-----------------|------|---------------|-------------------|

Back to Back Fix

| | | | | | |
|------------------|------|-------|------|----|------|
| MDZ B8430 | 1500 | 25x12 | Pair | 70 | 1660 |
| MDZ B8430 | 1000 | 25x12 | Pair | 70 | 1160 |
| MDZ B8430 | 800 | 25x12 | Pair | 70 | 960 |
| MDZ B8430 | 600 | 25x12 | Pair | 70 | 760 |
| MDZ B8430 | 400 | 25x12 | Pair | 70 | 560 |

Disk Fix

| | | | | | |
|------------------|------|-------|--------|----|------|
| MDZ D8430 | 1500 | 25x12 | Single | 70 | 1660 |
| MDZ D8430 | 1000 | 25x12 | Single | 70 | 1160 |
| MDZ D8430 | 800 | 25x12 | Single | 70 | 960 |
| MDZ D8430 | 600 | 25x12 | Single | 70 | 760 |
| MDZ D8430 | 400 | 25x12 | Single | 70 | 560 |

Concealed Fix

| | | | | | |
|------------------|------|-------|--------|----|------|
| MDZ C8430 | 1500 | 25x12 | Single | 70 | 1660 |
| MDZ C8430 | 1000 | 25x12 | Single | 70 | 1160 |
| MDZ C8430 | 800 | 25x12 | Single | 70 | 960 |
| MDZ C8430 | 600 | 25x12 | Single | 70 | 760 |
| MDZ C8430 | 400 | 25x12 | Single | 70 | 560 |

NOTE:
Special sizes available on request



HOW TO SPECIFY

Product No. / Fixing Centres / Rail Section / Finish / Fixing (refer diagram below)
eg: B8430 / 800 / 25x12 / SSS / TM

B = BACK TO BACK FIX

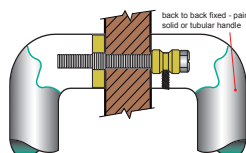

D = DISK FIX

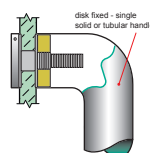

C = CONCEALED FIX

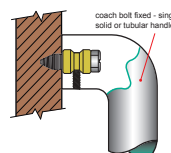

PLEASE SPECIFY DOOR TYPE

GD - Glass doors

TM - Timber doors

AL - Aluminium doors

Entry Door Pull Handle

Material 316 Marine Grade Stainless Steel
Insert Melunak (Plantation Grown Hardwood)



| Product No. | Fixing Centres mm | Rail Section mm | Unit | Projection mm | Overall Length mm |
|-------------|-------------------|-----------------|------|---------------|-------------------|
|-------------|-------------------|-----------------|------|---------------|-------------------|

Back to Back Fix

| | | | | | |
|------------------|------|-------|------|----|------|
| MDZ B8440 | 1500 | 50x25 | Pair | 75 | 1525 |
| MDZ B8440 | 1000 | 50x25 | Pair | 75 | 1025 |
| MDZ B8440 | 800 | 50x25 | Pair | 75 | 825 |
| MDZ B8440 | 600 | 50x25 | Pair | 75 | 625 |
| MDZ B8440 | 400 | 50x25 | Pair | 75 | 425 |

Disk Fix

| | | | | | |
|------------------|------|-------|--------|----|------|
| MDZ D8440 | 1500 | 50x25 | Single | 75 | 1525 |
| MDZ D8440 | 1000 | 50x25 | Single | 75 | 1025 |
| MDZ D8440 | 800 | 50x25 | Single | 75 | 825 |
| MDZ D8440 | 600 | 50x25 | Single | 75 | 625 |
| MDZ D8440 | 400 | 50x25 | Single | 75 | 425 |

Concealed Fix

| | | | | | |
|------------------|------|-------|--------|----|------|
| MDZ C8440 | 1500 | 50x25 | Single | 75 | 1525 |
| MDZ C8440 | 1000 | 50x25 | Single | 75 | 1025 |
| MDZ C8440 | 800 | 50x25 | Single | 75 | 825 |
| MDZ C8440 | 600 | 50x25 | Single | 75 | 625 |
| MDZ C8440 | 400 | 50x25 | Single | 75 | 425 |

NOTE:
Other timbers available on request



HOW TO SPECIFY

Product No. / Fixing Centres / Rail Section / Finish / Fixing (refer diagram below)

eg: B8440 / 800 / 50x25 / SSS / TM

B = BACK TO BACK FIX

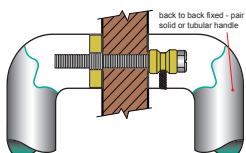

D = DISK FIX

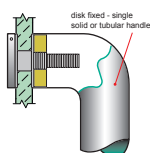

C = CONCEALED FIX

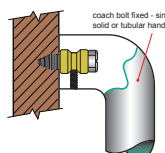

PLEASE SPECIFY DOOR TYPE

GD - Glass doors

TM - Timber doors

AL - Aluminium doors

Entry Door Pull Handle

Material 316 Marine Grade Stainless Steel
Insert Melunak (Plantation Grown Hardwood)



| Product No. | Fixing Centres mm | Rail Section mm | Unit | Projection mm | Overall Length mm |
|-------------|-------------------|-----------------|------|---------------|-------------------|
|-------------|-------------------|-----------------|------|---------------|-------------------|

Back to Back Fix

| | | | | | |
|-----------|------|-------|------|----|------|
| MDZ B8445 | 1500 | 50x25 | Pair | 75 | 1525 |
| MDZ B8445 | 1000 | 50x25 | Pair | 75 | 1025 |
| MDZ B8445 | 800 | 50x25 | Pair | 75 | 825 |
| MDZ B8445 | 600 | 50x25 | Pair | 75 | 625 |
| MDZ B8445 | 400 | 50x25 | Pair | 75 | 425 |

Disk Fix

| | | | | | |
|-----------|------|-------|--------|----|------|
| MDZ D8445 | 1500 | 50x25 | Single | 75 | 1525 |
| MDZ D8445 | 1000 | 50x25 | Single | 75 | 1025 |
| MDZ D8445 | 800 | 50x25 | Single | 75 | 825 |
| MDZ D8445 | 600 | 50x25 | Single | 75 | 625 |
| MDZ D8445 | 400 | 50x25 | Single | 75 | 425 |

Concealed Fix

| | | | | | |
|-----------|------|-------|--------|----|------|
| MDZ C8445 | 1500 | 50x25 | Single | 75 | 1525 |
| MDZ C8445 | 1000 | 50x25 | Single | 75 | 1025 |
| MDZ C8445 | 800 | 50x25 | Single | 75 | 825 |
| MDZ C8445 | 600 | 50x25 | Single | 75 | 625 |
| MDZ C8445 | 400 | 50x25 | Single | 75 | 425 |

NOTE:
Other timbers available on request



HOW TO SPECIFY

Product No. / Fixing Centres / Rail Section / Finish / Fixing (refer diagram below)
eg: B8445 / 800 / 50x25 / SSS / TM

B = BACK TO BACK FIX

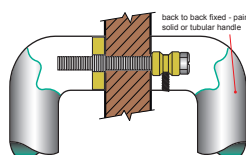

D = DISK FIX

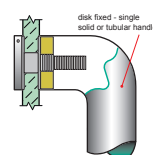

C = CONCEALED FIX

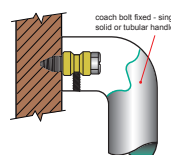

PLEASE SPECIFY DOOR TYPE

- GD** - Glass doors
- TM** - Timber doors
- AL** - Aluminium doors

Entry Door Pull Handle

Material 316 Marine Grade Stainless Steel
Insert Melunak (Plantation Grown Hardwood)



| Product No. | Fixing Centres mm | Rail Section mm | Standoff mm | Unit | Projection mm | Overall Length mm |
|-------------|-------------------|-----------------|-------------|------|---------------|-------------------|
|-------------|-------------------|-----------------|-------------|------|---------------|-------------------|

Back to Back Fix

| | | | | | | |
|------------------|------|-------|-------|------|----|------|
| MDZ B8450 | 1340 | 32x32 | 25x25 | Pair | 70 | 1500 |
| MDZ B8450 | 840 | 32x32 | 25x25 | Pair | 70 | 1000 |
| MDZ B8450 | 640 | 32x32 | 25x25 | Pair | 70 | 800 |
| MDZ B8450 | 440 | 32x32 | 25x25 | Pair | 70 | 600 |
| MDZ B8450 | 240 | 32x32 | 25x25 | Pair | 70 | 400 |

Disk Fix

| | | | | | | |
|------------------|------|-------|-------|--------|----|------|
| MDZ D8450 | 1340 | 32x32 | 25x25 | Single | 70 | 1500 |
| MDZ D8450 | 840 | 32x32 | 25x25 | Single | 70 | 1000 |
| MDZ D8450 | 640 | 32x32 | 25x25 | Single | 70 | 800 |
| MDZ D8450 | 440 | 32x32 | 25x25 | Single | 70 | 600 |
| MDZ D8450 | 240 | 32x32 | 25x25 | Single | 70 | 400 |

Concealed Fix

| | | | | | | |
|------------------|------|-------|-------|--------|----|------|
| MDZ C8450 | 1340 | 32x32 | 25x25 | Single | 70 | 1500 |
| MDZ C8450 | 840 | 32x32 | 25x25 | Single | 70 | 1000 |
| MDZ C8450 | 640 | 32x32 | 25x25 | Single | 70 | 800 |
| MDZ C8450 | 440 | 32x32 | 25x25 | Single | 70 | 600 |
| MDZ C8450 | 240 | 32x32 | 25x25 | Single | 70 | 400 |

NOTE:
Other timbers available on request



HOW TO SPECIFY

Product No. / Fixing Centres / Rail Section / Finish / Fixing (refer diagram below)

eg: B8450 / 840 / 32x32 / SSS / TM

B = BACK TO BACK FIX

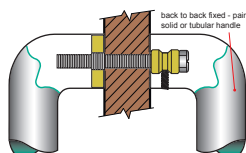

D = DISK FIX

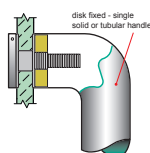

C = CONCEALED FIX

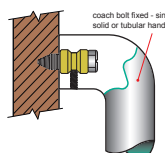

PLEASE SPECIFY DOOR TYPE

GD - Glass doors

TM - Timber doors

AL - Aluminium doors

Entry Door Pull Handle

Material 316 Marine Grade Stainless Steel
Insert Melunak (Plantation Grown Hardwood)



| Product No. | Fixing Centres mm | Rail Section mm | Standoff mm | Unit | Projection mm | Overall Length mm |
|-------------|-------------------|-----------------|-------------|------|---------------|-------------------|
|-------------|-------------------|-----------------|-------------|------|---------------|-------------------|

Back to Back Fix

| | | | | | | |
|------------------|------|-------|-------|------|----|------|
| MDZ B8455 | 1340 | 32x32 | 25x25 | Pair | 70 | 1500 |
| MDZ B8455 | 840 | 32x32 | 25x25 | Pair | 70 | 1000 |
| MDZ B8455 | 640 | 32x32 | 25x25 | Pair | 70 | 800 |
| MDZ B8455 | 440 | 32x32 | 25x25 | Pair | 70 | 600 |
| MDZ B8455 | 240 | 32x32 | 25x25 | Pair | 70 | 400 |

Disk Fix

| | | | | | | |
|------------------|------|-------|-------|--------|----|------|
| MDZ D8455 | 1340 | 32x32 | 25x25 | Single | 70 | 1500 |
| MDZ D8455 | 840 | 32x32 | 25x25 | Single | 70 | 1000 |
| MDZ D8455 | 640 | 32x32 | 25x25 | Single | 70 | 800 |
| MDZ D8455 | 440 | 32x32 | 25x25 | Single | 70 | 600 |
| MDZ D8455 | 240 | 32x32 | 25x25 | Single | 70 | 400 |

Concealed Fix

| | | | | | | |
|------------------|------|-------|-------|--------|----|------|
| MDZ C8455 | 1340 | 32x32 | 25x25 | Single | 70 | 1500 |
| MDZ C8455 | 840 | 32x32 | 25x25 | Single | 70 | 1000 |
| MDZ C8455 | 640 | 32x32 | 25x25 | Single | 70 | 800 |
| MDZ C8455 | 440 | 32x32 | 25x25 | Single | 70 | 600 |
| MDZ C8455 | 240 | 32x32 | 25x25 | Single | 70 | 400 |

NOTE:
Other timbers available on request



HOW TO SPECIFY

Product No. / Fixing Centres / Rail Section / Finish / Fixing (refer diagram below)
eg: B8455 / 840 / 32x32 / SSS / TM

B = BACK TO BACK FIX

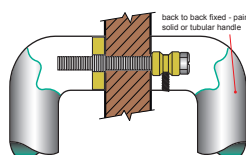

D = DISK FIX

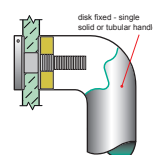

C = CONCEALED FIX

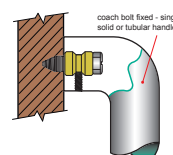

PLEASE SPECIFY DOOR TYPE

- GD** - Glass doors
- TM** - Timber doors
- AL** - Aluminium doors

Entry Door Pull Handle

Material 316 Marine Grade Stainless Steel
Insert Melunak (Plantation Grown Hardwood)



| Product No. | Fixing Centres mm | Rail Section mm | Unit | Projection mm | Overall Length mm |
|-------------|-------------------|-----------------|------|---------------|-------------------|
|-------------|-------------------|-----------------|------|---------------|-------------------|

Back to Back Fix

| | | | | | |
|------------------|------|-------|------|----|------|
| MDZ B8460 | 1000 | 40x10 | Pair | 65 | 1160 |
| MDZ B8460 | 800 | 40x10 | Pair | 65 | 960 |
| MDZ B8460 | 600 | 40x10 | Pair | 65 | 760 |
| MDZ B8460 | 400 | 40x10 | Pair | 65 | 560 |

Disk Fix

| | | | | | |
|------------------|------|-------|--------|----|------|
| MDZ D8460 | 1000 | 40x10 | Single | 65 | 1160 |
| MDZ D8460 | 800 | 40x10 | Single | 65 | 960 |
| MDZ D8460 | 600 | 40x10 | Single | 65 | 760 |
| MDZ D8460 | 400 | 40x10 | Single | 65 | 560 |

Concealed Fix

| | | | | | |
|------------------|------|-------|--------|----|------|
| MDZ C8460 | 1000 | 40x10 | Single | 65 | 1160 |
| MDZ C8460 | 800 | 40x10 | Single | 65 | 960 |
| MDZ C8460 | 600 | 40x10 | Single | 65 | 760 |
| MDZ C8460 | 400 | 40x10 | Single | 65 | 560 |

NOTE:
Other timbers available on request

HOW TO SPECIFY

Product No. / Fixing Centres / Rail Section / Finish / Fixing (refer diagram below)

eg: B8460 / 800 / 40x10 / SSS / TM

B = BACK TO BACK FIX

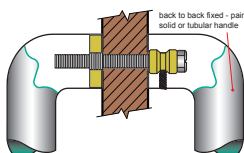

D = DISK FIX

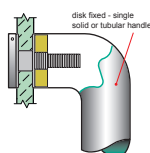

C = CONCEALED FIX

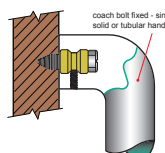

PLEASE SPECIFY DOOR TYPE

GD - Glass doors

TM - Timber doors

AL - Aluminium doors

Entry Door Pull Handle

Material 316 Marine Grade Stainless Steel
Insert Melunak (Plantation Grown Hardwood)



| Product No. | Fixing Centres mm | Rail Section mm | Unit | Projection mm | Overall Length mm |
|-------------|-------------------|-----------------|------|---------------|-------------------|
|-------------|-------------------|-----------------|------|---------------|-------------------|

Back to Back Fix

| | | | | | |
|------------------|------|-------|------|----|------|
| MDZ B8465 | 1000 | 40x10 | Pair | 65 | 1160 |
| MDZ B8465 | 800 | 40x10 | Pair | 65 | 960 |
| MDZ B8465 | 600 | 40x10 | Pair | 65 | 760 |
| MDZ B8465 | 400 | 40x10 | Pair | 65 | 560 |

Disk Fix

| | | | | | |
|------------------|------|-------|--------|----|------|
| MDZ D8465 | 1000 | 40x10 | Single | 65 | 1160 |
| MDZ D8465 | 800 | 40x10 | Single | 65 | 960 |
| MDZ D8465 | 600 | 40x10 | Single | 65 | 760 |
| MDZ D8465 | 400 | 40x10 | Single | 65 | 560 |

Concealed Fix

| | | | | | |
|------------------|------|-------|--------|----|------|
| MDZ C8465 | 1000 | 40x10 | Single | 65 | 1160 |
| MDZ C8465 | 800 | 40x10 | Single | 65 | 960 |
| MDZ C8465 | 600 | 40x10 | Single | 65 | 760 |
| MDZ C8465 | 400 | 40x10 | Single | 65 | 560 |

NOTE:
Other timbers available on request

HOW TO SPECIFY

Product No. / Fixing Centres / Rail Section / Finish / Fixing (refer diagram below)
eg: B8465 / 800 / 40x10 / SSS / TM

B = BACK TO BACK FIX

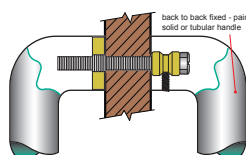

D = DISK FIX

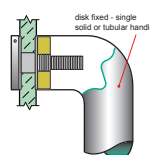

C = CONCEALED FIX

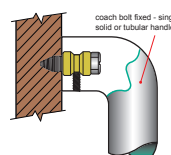

PLEASE SPECIFY DOOR TYPE

- GD** - Glass doors
- TM** - Timber doors
- AL** - Aluminium doors

Entry Door Pull Handle

Material 316 Marine Grade Stainless Steel
Insert Melunak (Plantation Grown Hardwood)



| Product No. | Diameter mm | Projection mm | Length mm | Fixing Centres mm |
|-------------|-------------|---------------|-----------|-------------------|
| MDZ 8470/A | 32 | 76 | 2400 | 2240 |
| MDZ 8470/B | 32 | 76 | 2300 | 2140 |
| MDZ 8470/C | 32 | 76 | 2200 | 2040 |
| MDZ 8470/D | 32 | 76 | 2100 | 1940 |
| MDZ 8470/E | 32 | 76 | 2000 | 1840 |
| MDZ 8470/F | 32 | 76 | 1900 | 1740 |
| MDZ 8470/G | 32 | 76 | 1800 | 1640 |
| MDZ 8470/H | 32 | 76 | 1700 | 1540 |
| MDZ 8470/I | 32 | 76 | 1600 | 1440 |
| MDZ 8470/J | 32 | 76 | 1500 | 1340 |
| MDZ 8470/K | 32 | 76 | 1400 | 1240 |
| MDZ 8470/L | 32 | 76 | 1300 | 1140 |
| MDZ 8470/M | 32 | 76 | 1200 | 1040 |
| MDZ 8470/N | 32 | 76 | 1100 | 940 |
| MDZ 8470/O | 32 | 76 | 1000 | 840 |
| MDZ 8470/P | 32 | 76 | 900 | 740 |
| MDZ 8470/Q | 32 | 76 | 800 | 640 |
| MDZ 8470/R | 32 | 76 | 700 | 540 |
| MDZ 8470/S | 32 | 76 | 600 | 440 |
| MDZ 8470/T | 32 | 76 | 500 | 340 |
| MDZ 8470/U | 32 | 76 | 400 | 240 |

NOTE:

MDZ 8470/A to E to come with 3 stand offs (fixing points)

Special sizes available on request

Other timbers available on request



HOW TO SPECIFY

Product No. / Diameter / Projection / Finish / Fixing (refer diagram below)

eg: 8470A / 32 / 76 / SSS / TM

B = BACK TO BACK FIX

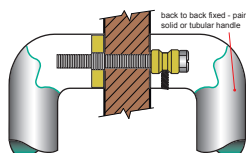

D = DISK FIX

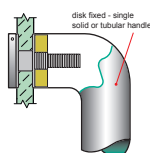

C = CONCEALED FIX

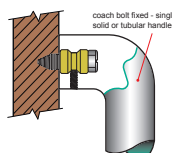

PLEASE SPECIFY DOOR TYPE

GD - Glass doors

TM - Timber doors

AL - Aluminium doors

Entry Door Pull Handle

Material 316 Marine Grade Stainless Steel
Insert Melunak (Plantation Grown Hardwood)



| Product No. | Diameter mm | Projection mm | Length mm | Fixing Centres mm |
|-------------|-------------|---------------|-----------|-------------------|
| MDZ 8475/A | 32 | 76 | 2400 | 2240 |
| MDZ 8475/B | 32 | 76 | 2300 | 2140 |
| MDZ 8475/C | 32 | 76 | 2200 | 2040 |
| MDZ 8475/D | 32 | 76 | 2100 | 1940 |
| MDZ 8475/E | 32 | 76 | 2000 | 1840 |
| MDZ 8475/F | 32 | 76 | 1900 | 1740 |
| MDZ 8475/G | 32 | 76 | 1800 | 1640 |
| MDZ 8475/H | 32 | 76 | 1700 | 1540 |
| MDZ 8475/I | 32 | 76 | 1600 | 1440 |
| MDZ 8475/J | 32 | 76 | 1500 | 1340 |
| MDZ 8475/K | 32 | 76 | 1400 | 1240 |
| MDZ 8475/L | 32 | 76 | 1300 | 1140 |
| MDZ 8475/M | 32 | 76 | 1200 | 1040 |
| MDZ 8475/N | 32 | 76 | 1100 | 940 |
| MDZ 8475/O | 32 | 76 | 1000 | 840 |
| MDZ 8475/P | 32 | 76 | 900 | 740 |
| MDZ 8475/Q | 32 | 76 | 800 | 640 |
| MDZ 8475/R | 32 | 76 | 700 | 540 |
| MDZ 8475/S | 32 | 76 | 600 | 440 |
| MDZ 8475/T | 32 | 76 | 500 | 340 |
| MDZ 8475/U | 32 | 76 | 400 | 240 |

NOTE:

MDZ 8475/A to E to come with 3 stand offs (fixing points)

Special sizes available on request

Other timbers available on request



HOW TO SPECIFY

Product No. / Diameter / Projection / Finish / Fixing (refer diagram below)

eg: 8475A / 32 / 76 / SSS / TM

B = BACK TO BACK FIX

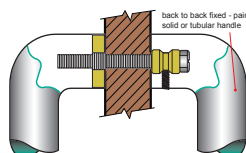

D = DISK FIX

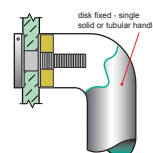

C = CONCEALED FIX

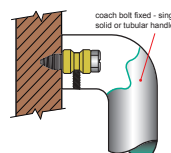

PLEASE SPECIFY DOOR TYPE

GD - Glass doors

TM - Timber doors

AL - Aluminium doors

Entry Door Pull Handle

Material 316 Marine Grade Stainless Steel
Insert Melunak (Plantation Grown Hardwood)



| Product No. | Diameter mm | Projection mm | Length mm | Fixing Centres mm |
|-------------|-------------|---------------|-----------|-------------------|
| MDZ 8480/A | 32 | 75 | 2400 | 2240 |
| MDZ 8480/B | 32 | 75 | 2300 | 2140 |
| MDZ 8480/C | 32 | 75 | 2200 | 2040 |
| MDZ 8480/D | 32 | 75 | 2100 | 1940 |
| MDZ 8480/E | 32 | 75 | 2000 | 1840 |
| MDZ 8480/F | 32 | 75 | 1900 | 1740 |
| MDZ 8480/G | 32 | 75 | 1800 | 1640 |
| MDZ 8480/H | 32 | 75 | 1700 | 1540 |
| MDZ 8480/I | 32 | 75 | 1600 | 1440 |
| MDZ 8480/J | 32 | 75 | 1500 | 1340 |
| MDZ 8480/K | 32 | 75 | 1400 | 1240 |
| MDZ 8480/L | 32 | 75 | 1300 | 1140 |
| MDZ 8480/M | 32 | 75 | 1200 | 1040 |
| MDZ 8480/N | 32 | 75 | 1100 | 940 |
| MDZ 8480/O | 32 | 75 | 1000 | 840 |
| MDZ 8480/P | 32 | 75 | 900 | 740 |
| MDZ 8480/Q | 32 | 75 | 800 | 640 |
| MDZ 8480/R | 32 | 75 | 700 | 540 |
| MDZ 8480/S | 32 | 75 | 600 | 440 |
| MDZ 8480/T | 32 | 75 | 500 | 340 |
| MDZ 8480/U | 32 | 75 | 400 | 240 |

NOTE:

MDZ 8480/A to E to come with 3 stand offs (fixing points)

Special sizes available on request

Other timbers available on request



HOW TO SPECIFY

Product No. / Diameter / Projection / Finish / Fixing (refer diagram below)

eg: 8480A / 32 / 75 / SSS / TM

B = BACK TO BACK FIX

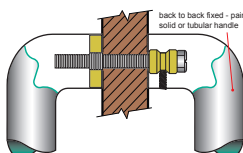

D = DISK FIX

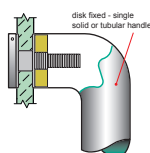

C = CONCEALED FIX

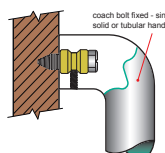

PLEASE SPECIFY DOOR TYPE

GD - Glass doors

TM - Timber doors

AL - Aluminium doors

Entry Door Pull Handle

Material 316 Marine Grade Stainless Steel
Insert Melunak (Plantation Grown Hardwood)



| Product No. | Diameter mm | Projection mm | Length mm | Fixing Centres mm |
|-------------|-------------|---------------|-----------|-------------------|
| MDZ 8485/A | 32 | 75 | 2400 | 2240 |
| MDZ 8485/B | 32 | 75 | 2300 | 2140 |
| MDZ 8485/C | 32 | 75 | 2200 | 2040 |
| MDZ 8485/D | 32 | 75 | 2100 | 1940 |
| MDZ 8485/E | 32 | 75 | 2000 | 1840 |
| MDZ 8485/F | 32 | 75 | 1900 | 1740 |
| MDZ 8485/G | 32 | 75 | 1800 | 1640 |
| MDZ 8485/H | 32 | 75 | 1700 | 1540 |
| MDZ 8485/I | 32 | 75 | 1600 | 1440 |
| MDZ 8485/J | 32 | 75 | 1500 | 1340 |
| MDZ 8485/K | 32 | 75 | 1400 | 1240 |
| MDZ 8485/L | 32 | 75 | 1300 | 1140 |
| MDZ 8485/M | 32 | 75 | 1200 | 1040 |
| MDZ 8485/N | 32 | 75 | 1100 | 940 |
| MDZ 8485/O | 32 | 75 | 1000 | 840 |
| MDZ 8485/P | 32 | 75 | 900 | 740 |
| MDZ 8485/Q | 32 | 75 | 800 | 640 |
| MDZ 8485/R | 32 | 75 | 700 | 540 |
| MDZ 8485/S | 32 | 75 | 600 | 440 |
| MDZ 8485/T | 32 | 75 | 500 | 340 |
| MDZ 8485/U | 32 | 75 | 400 | 240 |

NOTE:

MDZ 8485/A to E to come with 3 stand offs (fixing points)

Special sizes available on request

Other timbers available on request



HOW TO SPECIFY

Product No. / Diameter / Projection / Finish / Fixing (refer diagram below)

eg: 8485A / 32 / 75 / SSS / TM

B = BACK TO BACK FIX

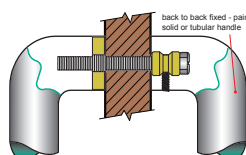

D = DISK FIX

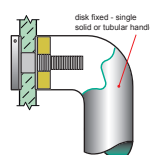

C = CONCEALED FIX

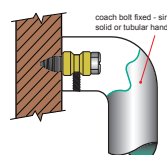

PLEASE SPECIFY DOOR TYPE

GD - Glass doors

TM - Timber doors

AL - Aluminium doors

Entry Door Pull Handle

Material 316 Marine Grade Stainless Steel
Insert Melunak (Plantation Grown Hardwood)

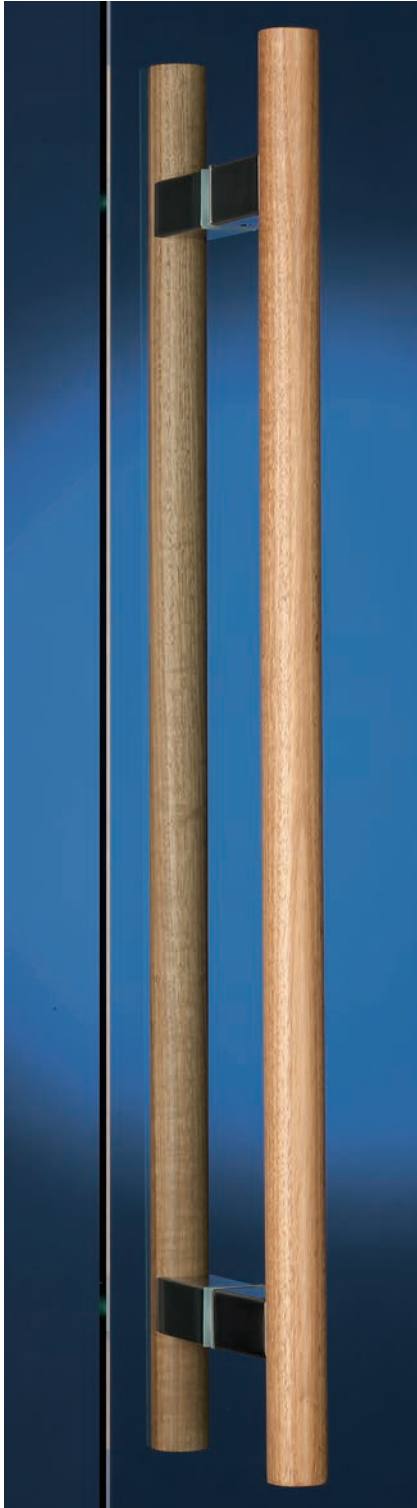

| Product No. | Diameter mm | Projection mm | Length mm | Fixing Centres mm |
|-------------|-------------|---------------|-----------|-------------------|
| MDZ 8490/A | 32 | 77 | 2400 | 2240 |
| MDZ 8490/B | 32 | 77 | 2300 | 2140 |
| MDZ 8490/C | 32 | 77 | 2200 | 2040 |
| MDZ 8490/D | 32 | 77 | 2100 | 1940 |
| MDZ 8490/E | 32 | 77 | 2000 | 1840 |
| MDZ 8490/F | 32 | 77 | 1900 | 1740 |
| MDZ 8490/G | 32 | 77 | 1800 | 1640 |
| MDZ 8490/H | 32 | 77 | 1700 | 1540 |
| MDZ 8490/I | 32 | 77 | 1600 | 1440 |
| MDZ 8490/J | 32 | 77 | 1500 | 1340 |
| MDZ 8490/K | 32 | 77 | 1400 | 1240 |
| MDZ 8490/L | 32 | 77 | 1300 | 1140 |
| MDZ 8490/M | 32 | 77 | 1200 | 1040 |
| MDZ 8490/N | 32 | 77 | 1100 | 940 |
| MDZ 8490/O | 32 | 77 | 1000 | 840 |
| MDZ 8490/P | 32 | 77 | 900 | 740 |
| MDZ 8490/Q | 32 | 77 | 800 | 640 |
| MDZ 8490/R | 32 | 77 | 700 | 540 |
| MDZ 8490/S | 32 | 77 | 600 | 440 |
| MDZ 8490/T | 32 | 77 | 500 | 340 |
| MDZ 8490/U | 32 | 77 | 400 | 240 |

NOTE:

MDZ 8490/A to E to come with 3 stand offs (fixing points)

Special sizes available on request

Other timbers available on request



HOW TO SPECIFY

Product No. / Diameter / Projection / Finish / Fixing (refer diagram below)

eg: 8490A / 32 / 77 / SSS / TM

B = BACK TO BACK FIX

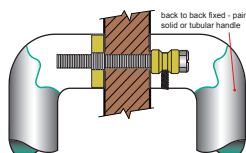

D = DISK FIX

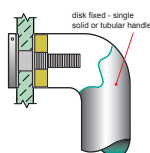

C = CONCEALED FIX

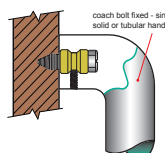

PLEASE SPECIFY DOOR TYPE

GD - Glass doors

TM - Timber doors

AL - Aluminium doors

Entry Door Pull Handle

Material 316 Marine Grade Stainless Steel
Insert Melunak (Plantation Grown Hardwood)



| Product No. | Diameter mm | Projection mm | Length mm | Fixing Centres mm |
|-------------|-------------|---------------|-----------|-------------------|
| MDZ 8495/A | 32 | 77 | 2400 | 2240 |
| MDZ 8495/B | 32 | 77 | 2300 | 2140 |
| MDZ 8495/C | 32 | 77 | 2200 | 2040 |
| MDZ 8495/D | 32 | 77 | 2100 | 1940 |
| MDZ 8495/E | 32 | 77 | 2000 | 1840 |
| MDZ 8495/F | 32 | 77 | 1900 | 1740 |
| MDZ 8495/G | 32 | 77 | 1800 | 1640 |
| MDZ 8495/H | 32 | 77 | 1700 | 1540 |
| MDZ 8495/I | 32 | 77 | 1600 | 1440 |
| MDZ 8495/J | 32 | 77 | 1500 | 1340 |
| MDZ 8495/K | 32 | 77 | 1400 | 1240 |
| MDZ 8495/L | 32 | 77 | 1300 | 1140 |
| MDZ 8495/M | 32 | 77 | 1200 | 1040 |
| MDZ 8495/N | 32 | 77 | 1100 | 940 |
| MDZ 8495/O | 32 | 77 | 1000 | 840 |
| MDZ 8495/P | 32 | 77 | 900 | 740 |
| MDZ 8495/Q | 32 | 77 | 800 | 640 |
| MDZ 8495/R | 32 | 77 | 700 | 540 |
| MDZ 8495/S | 32 | 77 | 600 | 440 |
| MDZ 8495/T | 32 | 77 | 500 | 340 |
| MDZ 8495/U | 32 | 77 | 400 | 240 |

NOTE:

MDZ 8495/A to E to come with 3 stand offs (fixing points)

Special sizes available on request

Other timbers available on request



HOW TO SPECIFY

Product No. / Diameter / Projection / Finish / Fixing (refer diagram below)

eg: 8495A / 32 / 77 / SSS / TM

B = BACK TO BACK FIX

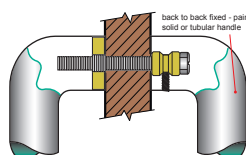

D = DISK FIX

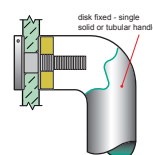

C = CONCEALED FIX

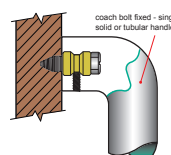

PLEASE SPECIFY DOOR TYPE

GD - Glass doors

TM - Timber doors

AL - Aluminium doors

Entry Door Pull Handle

Material 316 Marine Grade Stainless Steel
Insert Melunak (Plantation Grown Hardwood)



| Product No. | Fixing Centres mm | Rail Section mm | Unit | Projection mm | Overall Length mm |
|-------------|-------------------|-----------------|------|---------------|-------------------|
|-------------|-------------------|-----------------|------|---------------|-------------------|

Back to Back Fix

| | | | | | |
|------------------|------|-------|------|----|------|
| MDZ B8500 | 1500 | 50x25 | Pair | 70 | 1550 |
| MDZ B8500 | 1000 | 50x25 | Pair | 70 | 1050 |
| MDZ B8500 | 800 | 50x25 | Pair | 70 | 850 |
| MDZ B8500 | 600 | 50x25 | Pair | 70 | 650 |
| MDZ B8500 | 400 | 50x25 | Pair | 70 | 450 |

Disk Fix

| | | | | | |
|------------------|------|-------|--------|----|------|
| MDZ D8500 | 1500 | 50x25 | Single | 70 | 1550 |
| MDZ D8500 | 1000 | 50x25 | Single | 70 | 1050 |
| MDZ D8500 | 800 | 50x25 | Single | 70 | 850 |
| MDZ D8500 | 600 | 50x25 | Single | 70 | 650 |
| MDZ D8500 | 400 | 50x25 | Single | 70 | 450 |

Concealed Fix

| | | | | | |
|------------------|------|-------|--------|----|------|
| MDZ C8500 | 1500 | 50x25 | Single | 70 | 1550 |
| MDZ C8500 | 1000 | 50x25 | Single | 70 | 1050 |
| MDZ C8500 | 800 | 50x25 | Single | 70 | 850 |
| MDZ C8500 | 600 | 50x25 | Single | 70 | 650 |
| MDZ C8500 | 400 | 50x25 | Single | 70 | 450 |

NOTE:
Special sizes available on request
Other timbers available on request



HOW TO SPECIFY

Product No. / Fixing Centres / Rail Section / Finish / Fixing (refer diagram below)

eg: B8500 / 800 / 50x25 / SSS / TM

B = BACK TO BACK FIX

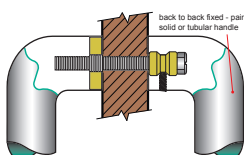

D = DISK FIX

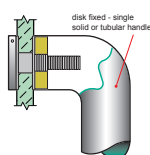

C = CONCEALED FIX

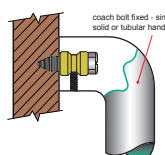

PLEASE SPECIFY DOOR TYPE

GD - Glass doors

TM - Timber doors

AL - Aluminium doors

Entry Door Pull Handle

Material 316 Marine Grade Stainless Steel
Insert Melunak (Plantation Grown Hardwood)



| Product No. | Fixing Centres mm | Rail Section mm | Unit | Projection mm | Overall Length mm |
|-------------|-------------------|-----------------|------|---------------|-------------------|
|-------------|-------------------|-----------------|------|---------------|-------------------|

Back to Back Fix

| | | | | | |
|-----------|------|-------|------|----|------|
| MDZ B8505 | 1500 | 50x25 | Pair | 70 | 1550 |
| MDZ B8505 | 1000 | 50x25 | Pair | 70 | 1050 |
| MDZ B8505 | 800 | 50x25 | Pair | 70 | 850 |
| MDZ B8505 | 600 | 50x25 | Pair | 70 | 650 |
| MDZ B8505 | 400 | 50x25 | Pair | 70 | 450 |

Disk Fix

| | | | | | |
|-----------|------|-------|--------|----|------|
| MDZ D8505 | 1500 | 50x25 | Single | 70 | 1550 |
| MDZ D8505 | 1000 | 50x25 | Single | 70 | 1050 |
| MDZ D8505 | 800 | 50x25 | Single | 70 | 850 |
| MDZ D8505 | 600 | 50x25 | Single | 70 | 650 |
| MDZ D8505 | 400 | 50x25 | Single | 70 | 450 |

Concealed Fix

| | | | | | |
|-----------|------|-------|--------|----|------|
| MDZ C8505 | 1500 | 50x25 | Single | 70 | 1550 |
| MDZ C8505 | 1000 | 50x25 | Single | 70 | 1050 |
| MDZ C8505 | 800 | 50x25 | Single | 70 | 850 |
| MDZ C8505 | 600 | 50x25 | Single | 70 | 650 |
| MDZ C8505 | 400 | 50x25 | Single | 70 | 450 |

NOTE:
Special sizes available on request
Other timbers available on request



HOW TO SPECIFY

Product No. / Fixing Centres / Rail Section / Finish / Fixing (refer diagram below)
eg: B8505 / 800 / 50x25 / SSS / TM

B = BACK TO BACK FIX

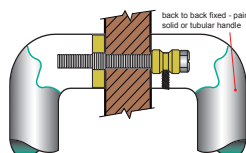

D = DISK FIX

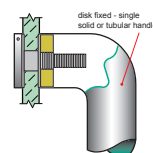

C = CONCEALED FIX

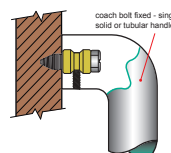

PLEASE SPECIFY DOOR TYPE

- GD** - Glass doors
- TM** - Timber doors
- AL** - Aluminium doors

Entry Door Pull Handle

Material 316 Marine Grade Stainless Steel
Insert Melunak (Plantation Grown Hardwood)



| Product No. | Fixing Centres mm | Rail Section mm | Unit | Projection mm | Overall Length mm |
|-------------|-------------------|-----------------|------|---------------|-------------------|
|-------------|-------------------|-----------------|------|---------------|-------------------|

Back to Back Fix

| | | | | | |
|------------------|------|-------|------|----|------|
| MDZ B8510 | 1500 | 32x32 | Pair | 77 | 1660 |
| MDZ B8510 | 1000 | 32x32 | Pair | 77 | 1160 |
| MDZ B8510 | 800 | 32x32 | Pair | 77 | 960 |
| MDZ B8510 | 600 | 32x32 | Pair | 77 | 760 |
| MDZ B8510 | 400 | 32x32 | Pair | 77 | 560 |

Disk Fix

| | | | | | |
|------------------|------|-------|--------|----|------|
| MDZ D8510 | 1500 | 32x32 | Single | 77 | 1660 |
| MDZ D8510 | 1000 | 32x32 | Single | 77 | 1160 |
| MDZ D8510 | 800 | 32x32 | Single | 77 | 960 |
| MDZ D8510 | 600 | 32x32 | Single | 77 | 760 |
| MDZ D8510 | 400 | 32x32 | Single | 77 | 560 |

Concealed Fix

| | | | | | |
|------------------|------|-------|--------|----|------|
| MDZ C8510 | 1500 | 32x32 | Single | 77 | 1660 |
| MDZ C8510 | 1000 | 32x32 | Single | 77 | 1160 |
| MDZ C8510 | 800 | 32x32 | Single | 77 | 960 |
| MDZ C8510 | 600 | 32x32 | Single | 77 | 760 |
| MDZ C8510 | 400 | 32x32 | Single | 77 | 560 |

NOTE:
Special sizes available on request
Other timbers available on request



HOW TO SPECIFY

Product No. / Fixing Centres / Rail Section / Finish / Fixing (refer diagram below)
eg: B8510 / 1500 / 32x32 / SSS / TM

B = BACK TO BACK FIX

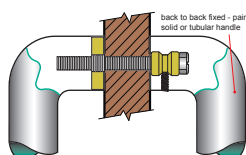

D = DISK FIX

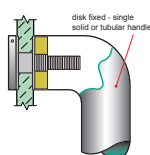

C = CONCEALED FIX

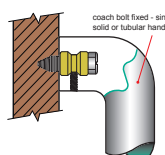

PLEASE SPECIFY DOOR TYPE

GD - Glass doors

TM - Timber doors

AL - Aluminium doors

Entry Door Pull Handle

Material 316 Marine Grade Stainless Steel
Insert Melunak (Plantation Grown Hardwood)



| Product No. | Fixing Centres mm | Rail Section mm | Unit | Projection mm | Overall Length mm |
|-------------|-------------------|-----------------|------|---------------|-------------------|
|-------------|-------------------|-----------------|------|---------------|-------------------|

Back to Back Fix

| | | | | | |
|-----------|------|-------|------|----|------|
| MDZ B8515 | 1500 | 32x32 | Pair | 77 | 1660 |
| MDZ B8515 | 1000 | 32x32 | Pair | 77 | 1160 |
| MDZ B8515 | 800 | 32x32 | Pair | 77 | 960 |
| MDZ B8515 | 600 | 32x32 | Pair | 77 | 760 |
| MDZ B8515 | 400 | 32x32 | Pair | 77 | 560 |

Disk Fix

| | | | | | |
|-----------|------|-------|--------|----|------|
| MDZ D8515 | 1500 | 32x32 | Single | 77 | 1660 |
| MDZ D8515 | 1000 | 32x32 | Single | 77 | 1160 |
| MDZ D8515 | 800 | 32x32 | Single | 77 | 960 |
| MDZ D8515 | 600 | 32x32 | Single | 77 | 760 |
| MDZ D8515 | 400 | 32x32 | Single | 77 | 560 |

Concealed Fix

| | | | | | |
|-----------|------|-------|--------|----|------|
| MDZ C8515 | 1500 | 32x32 | Single | 77 | 1660 |
| MDZ C8515 | 1000 | 32x32 | Single | 77 | 1160 |
| MDZ C8515 | 800 | 32x32 | Single | 77 | 960 |
| MDZ C8515 | 600 | 32x32 | Single | 77 | 760 |
| MDZ C8515 | 400 | 32x32 | Single | 77 | 560 |

NOTE:
Special sizes available on request
Other timbers available on request



HOW TO SPECIFY

Product No. / Fixing Centres / Rail Section / Finish / Fixing (refer diagram below)
eg: B8515 / 1500 / 32x32 / SSS / TM

B = BACK TO BACK FIX

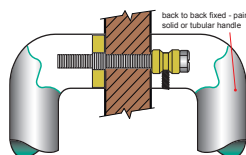

D = DISK FIX

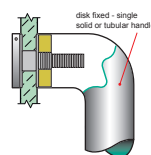

C = CONCEALED FIX

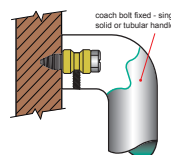

PLEASE SPECIFY DOOR TYPE

- GD** - Glass doors
- TM** - Timber doors
- AL** - Aluminium doors

Entry Door Pull Handle

Material 316 Marine Grade Stainless Steel
Insert Melunak (Plantation Grown Hardwood)



| Product No. | Fixing Centres mm | Rail Section mm | Unit | Projection mm | Overall Length mm |
|-------------|-------------------|-----------------|------|---------------|-------------------|
|-------------|-------------------|-----------------|------|---------------|-------------------|

Back to Back Fix

| | | | | | |
|------------------|------|-------|------|----|------|
| MDZ B8520 | 1500 | 32x32 | Pair | 77 | 1660 |
| MDZ B8520 | 1000 | 32x32 | Pair | 77 | 1160 |
| MDZ B8520 | 800 | 32x32 | Pair | 77 | 960 |
| MDZ B8520 | 600 | 32x32 | Pair | 77 | 760 |
| MDZ B8520 | 400 | 32x32 | Pair | 77 | 560 |

Disk Fix

| | | | | | |
|------------------|------|-------|--------|----|------|
| MDZ D8520 | 1500 | 32x32 | Single | 77 | 1660 |
| MDZ D8520 | 1000 | 32x32 | Single | 77 | 1160 |
| MDZ D8520 | 800 | 32x32 | Single | 77 | 960 |
| MDZ D8520 | 600 | 32x32 | Single | 77 | 760 |
| MDZ D8520 | 400 | 32x32 | Single | 77 | 560 |

Concealed Fix

| | | | | | |
|------------------|------|-------|--------|----|------|
| MDZ C8520 | 1500 | 32x32 | Single | 77 | 1660 |
| MDZ C8520 | 1000 | 32x32 | Single | 77 | 1160 |
| MDZ C8520 | 800 | 32x32 | Single | 77 | 960 |
| MDZ C8520 | 600 | 32x32 | Single | 77 | 760 |
| MDZ C8520 | 400 | 32x32 | Single | 77 | 560 |

NOTE:
Special sizes available on request
Other timbers available on request



HOW TO SPECIFY

Product No. / Fixing Centres / Rail Section / Finish / Fixing (refer diagram below)
eg: B8520 / 1500 / 32x32 / SSS / TM

B = BACK TO BACK FIX

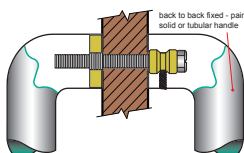

D = DISK FIX

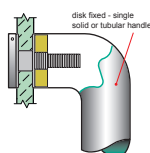

C = CONCEALED FIX

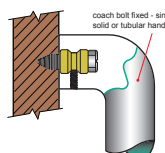

PLEASE SPECIFY DOOR TYPE

- GD** - Glass doors
- TM** - Timber doors
- AL** - Aluminium doors

Entry Door Pull Handle

Material 316 Marine Grade Stainless Steel
Insert Melunak (Plantation Grown Hardwood)



| Product No. | Fixing Centres mm | Rail Section mm | Unit | Projection mm | Overall Length mm |
|-------------|-------------------|-----------------|------|---------------|-------------------|
|-------------|-------------------|-----------------|------|---------------|-------------------|

Back to Back Fix

| | | | | | |
|-----------|------|-------|------|----|------|
| MDZ B8525 | 1500 | 32x32 | Pair | 77 | 1660 |
| MDZ B8525 | 1000 | 32x32 | Pair | 77 | 1160 |
| MDZ B8525 | 800 | 32x32 | Pair | 77 | 960 |
| MDZ B8525 | 600 | 32x32 | Pair | 77 | 760 |
| MDZ B8525 | 400 | 32x32 | Pair | 77 | 560 |

Disk Fix

| | | | | | |
|-----------|------|-------|--------|----|------|
| MDZ D8525 | 1500 | 32x32 | Single | 77 | 1660 |
| MDZ D8525 | 1000 | 32x32 | Single | 77 | 1160 |
| MDZ D8525 | 800 | 32x32 | Single | 77 | 960 |
| MDZ D8525 | 600 | 32x32 | Single | 77 | 760 |
| MDZ D8525 | 400 | 32x32 | Single | 77 | 560 |

Concealed Fix

| | | | | | |
|-----------|------|-------|--------|----|------|
| MDZ C8525 | 1500 | 32x32 | Single | 77 | 1660 |
| MDZ C8525 | 1000 | 32x32 | Single | 77 | 1160 |
| MDZ C8525 | 800 | 32x32 | Single | 77 | 960 |
| MDZ C8525 | 600 | 32x32 | Single | 77 | 760 |
| MDZ C8525 | 400 | 32x32 | Single | 77 | 560 |

NOTE:
Special sizes available on request
Other timbers available on request



HOW TO SPECIFY

Product No. / Fixing Centres / Rail Section / Finish / Fixing (refer diagram below)
eg: B8525 / 1500 / 32x32 / SSS / TM

B = BACK TO BACK FIX

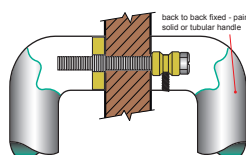

D = DISK FIX

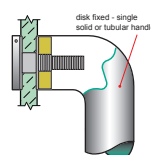

C = CONCEALED FIX

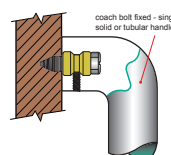

PLEASE SPECIFY DOOR TYPE

- GD** - Glass doors
- TM** - Timber doors
- AL** - Aluminium doors

Entry Door Pull Handle

Material 316 Marine Grade Stainless Steel
Insert Melunak (Plantation Grown Hardwood)



| Product No. | Fixing Centres mm | Rail Section mm | Unit | Projection mm | Overall Length mm |
|-------------|-------------------|-----------------|------|---------------|-------------------|
|-------------|-------------------|-----------------|------|---------------|-------------------|

Back to Back Fix

| | | | | | |
|-----------|------|-------|------|----|------|
| MDZ B8530 | 1500 | 32x32 | Pair | 77 | 1660 |
| MDZ B8530 | 1000 | 32x32 | Pair | 77 | 1160 |
| MDZ B8530 | 800 | 32x32 | Pair | 77 | 960 |
| MDZ B8530 | 600 | 32x32 | Pair | 77 | 760 |
| MDZ B8530 | 400 | 32x32 | Pair | 77 | 560 |

Disk Fix

| | | | | | |
|-----------|------|-------|--------|----|------|
| MDZ D8530 | 1500 | 32x32 | Single | 77 | 1660 |
| MDZ D8530 | 1000 | 32x32 | Single | 77 | 1160 |
| MDZ D8530 | 800 | 32x32 | Single | 77 | 960 |
| MDZ D8530 | 600 | 32x32 | Single | 77 | 760 |
| MDZ D8530 | 400 | 32x32 | Single | 77 | 560 |

Concealed Fix

| | | | | | |
|-----------|------|-------|--------|----|------|
| MDZ C8530 | 1500 | 32x32 | Single | 77 | 1660 |
| MDZ C8530 | 1000 | 32x32 | Single | 77 | 1160 |
| MDZ C8530 | 800 | 32x32 | Single | 77 | 960 |
| MDZ C8530 | 600 | 32x32 | Single | 77 | 760 |
| MDZ C8530 | 400 | 32x32 | Single | 77 | 560 |

NOTE:
Special sizes available on request
Other timbers available on request



HOW TO SPECIFY

Product No. / Fixing Centres / Rail Section / Finish / Fixing (refer diagram below)
eg: B8530 / 1500 / 32x32 / SSS / TM

B = BACK TO BACK FIX

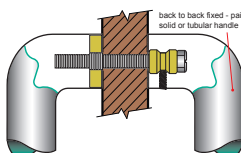

D = DISK FIX

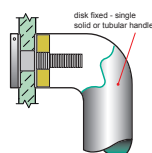

C = CONCEALED FIX

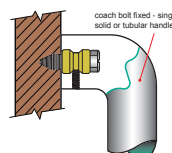

PLEASE SPECIFY DOOR TYPE

GD - Glass doors

TM - Timber doors

AL - Aluminium doors

Entry Door Pull Handle

Material 316 Marine Grade Stainless Steel
Insert Melunak (Plantation Grown Hardwood)



| Product No. | Fixing Centres mm | Rail Section mm | Unit | Projection mm | Overall Length mm |
|-------------|-------------------|-----------------|------|---------------|-------------------|
|-------------|-------------------|-----------------|------|---------------|-------------------|

Back to Back Fix

| | | | | | |
|-----------|------|-------|------|----|------|
| MDZ B8535 | 1500 | 32x32 | Pair | 77 | 1660 |
| MDZ B8535 | 1000 | 32x32 | Pair | 77 | 1160 |
| MDZ B8535 | 800 | 32x32 | Pair | 77 | 960 |
| MDZ B8535 | 600 | 32x32 | Pair | 77 | 760 |
| MDZ B8535 | 400 | 32x32 | Pair | 77 | 560 |

Disk Fix

| | | | | | |
|-----------|------|-------|--------|----|------|
| MDZ D8535 | 1500 | 32x32 | Single | 77 | 1660 |
| MDZ D8535 | 1000 | 32x32 | Single | 77 | 1160 |
| MDZ D8535 | 800 | 32x32 | Single | 77 | 960 |
| MDZ D8535 | 600 | 32x32 | Single | 77 | 760 |
| MDZ D8535 | 400 | 32x32 | Single | 77 | 560 |

Concealed Fix

| | | | | | |
|-----------|------|-------|--------|----|------|
| MDZ C8535 | 1500 | 32x32 | Single | 77 | 1660 |
| MDZ C8535 | 1000 | 32x32 | Single | 77 | 1160 |
| MDZ C8535 | 800 | 32x32 | Single | 77 | 960 |
| MDZ C8535 | 600 | 32x32 | Single | 77 | 760 |
| MDZ C8535 | 400 | 32x32 | Single | 77 | 560 |

NOTE:
Special sizes available on request
Other timbers available on request



HOW TO SPECIFY

Product No. / Fixing Centres / Rail Section / Finish / Fixing (refer diagram below)
eg: B8535 / 1500 / 32x32 / SSS / TM

B = BACK TO BACK FIX

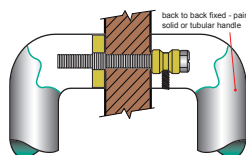

D = DISK FIX

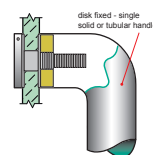

C = CONCEALED FIX

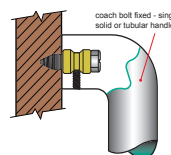

PLEASE SPECIFY DOOR TYPE

GD - Glass doors

TM - Timber doors

AL - Aluminium doors

Entry Door Pull Handle

Material 316 Marine Grade Stainless Steel
Insert Melunak (Plantation Grown Hardwood)



| Product No. | Fixing Centres mm | Flat Plate mm | Unit | Projection mm | Width mm | Overall Length mm |
|-------------------------|-------------------|---------------|--------|---------------|----------|-------------------|
| Back to Back Fix | | | | | | |
| MDZ B8540 | 200 | 32 | Pair | 77 | 150 | 400 |
| Disk Fix | | | | | | |
| MDZ D8540 | 200 | 32 | Single | 77 | 150 | 400 |
| Concealed Fix | | | | | | |
| MDZ C8540 | 200 | 32 | Single | 77 | 150 | 400 |

Entry Door Pull Handle

Material 316 Marine Grade Stainless Steel
Insert Melunak (Plantation Grown Hardwood)



| Product No. | Fixing Centres mm | Flat Plate mm | Unit | Projection mm | Width mm | Overall Length mm |
|-------------------------|-------------------|---------------|--------|---------------|----------|-------------------|
| Back to Back Fix | | | | | | |
| MDZ B8545 | 200 | 32 | Pair | 77 | 150 | 400 |
| Disk Fix | | | | | | |
| MDZ D8545 | 200 | 32 | Single | 77 | 150 | 400 |
| Concealed Fix | | | | | | |
| MDZ C8545 | 200 | 32 | Single | 77 | 150 | 400 |

Entry Door Pull Handle

Material 316 Marine Grade Stainless Steel
Insert Melunak (Plantation Grown Hardwood)



| Product No. | Fixing Centres mm | Diameter mm | Unit | Projection mm | Disc mm |
|-------------------------|-------------------|-------------|--------|---------------|---------|
| Back to Back Fix | | | | | |
| MDZ B8550 | 150 | 300 | Pair | 77 | 32 |
| MDZ B8550 | 100 | 200 | Pair | 77 | 32 |
| Disk Fix | | | | | |
| MDZ D8550 | 150 | 300 | Single | 77 | 32 |
| MDZ D8550 | 100 | 200 | Single | 77 | 32 |
| Concealed Fix | | | | | |
| MDZ C8550 | 150 | 300 | Single | 77 | 32 |
| MDZ C8550 | 100 | 200 | Single | 77 | 32 |

NOTE:
Special sizes available on request

Other timbers available on request

Entry Door Pull Handle

Material 316 Marine Grade Stainless Steel
Insert Melunak (Plantation Grown Hardwood)



| Product No. | Fixing Centres mm | Diameter mm | Unit | Projection mm | Disc mm |
|-------------------------|-------------------|-------------|--------|---------------|---------|
| Back to Back Fix | | | | | |
| MDZ B8555 | 150 | 300 | Pair | 77 | 32 |
| MDZ B8555 | 100 | 200 | Pair | 77 | 32 |
| Disk Fix | | | | | |
| MDZ D8555 | 150 | 300 | Single | 77 | 32 |
| MDZ D8555 | 100 | 200 | Single | 77 | 32 |
| Concealed Fix | | | | | |
| MDZ C8555 | 150 | 300 | Single | 77 | 32 |
| MDZ C8555 | 100 | 200 | Single | 77 | 32 |

NOTE:
Special sizes available on request

Other timbers available on request

Entry Door Pull Handle

Material 316 Marine Grade Stainless Steel
Insert Melunak (Plantation Grown Hardwood)



| Product No. | Fixing Centres mm | Section mm | Unit | Projection mm |
|-------------|-------------------|------------|------|---------------|
|-------------|-------------------|------------|------|---------------|

Back to Back Fix

| | | | | |
|------------------|-----|---------|------|----|
| MDZ B8560 | 100 | 200x200 | Pair | 77 |
|------------------|-----|---------|------|----|

Disk Fix

| | | | | |
|------------------|-----|---------|--------|----|
| MDZ D8560 | 100 | 200x200 | Single | 77 |
|------------------|-----|---------|--------|----|

Concealed Fix

| | | | | |
|------------------|-----|---------|--------|----|
| MDZ C8560 | 100 | 200x200 | Single | 77 |
|------------------|-----|---------|--------|----|

NOTE:
Special sizes available
on request

Other timbers
available on request

Entry Door Pull Handle

Material 316 Marine Grade Stainless Steel
Insert Melunak (Plantation Grown Hardwood)



| Product No. | Fixing Centres mm | Section mm | Unit | Projection mm |
|-------------|-------------------|------------|------|---------------|
|-------------|-------------------|------------|------|---------------|

Back to Back Fix

| | | | | |
|------------------|-----|---------|------|----|
| MDZ B8565 | 100 | 200x200 | Pair | 77 |
|------------------|-----|---------|------|----|

Disk Fix

| | | | | |
|------------------|-----|---------|--------|----|
| MDZ D8565 | 100 | 200x200 | Single | 77 |
|------------------|-----|---------|--------|----|

Concealed Fix

| | | | | |
|------------------|-----|---------|--------|----|
| MDZ C8565 | 100 | 200x200 | Single | 77 |
|------------------|-----|---------|--------|----|

NOTE:
Special sizes available
on request

Other timbers
available on request

Entry Door Pull Handle

Material 316 Marine Grade Stainless Steel
Insert Melunak (Plantation Grown Hardwood)



| Product No. | Diameter mm | Projection mm | Length mm | Fixing Centres mm |
|-------------|-------------|---------------|-----------|-------------------|
| MDZ 8570/A | 32 | 77 | 2400 | 2240 |
| MDZ 8570/B | 32 | 77 | 2300 | 2140 |
| MDZ 8570/C | 32 | 77 | 2200 | 2040 |
| MDZ 8570/D | 32 | 77 | 2100 | 1940 |
| MDZ 8570/E | 32 | 77 | 2000 | 1840 |
| MDZ 8570/F | 32 | 77 | 1900 | 1740 |
| MDZ 8570/G | 32 | 77 | 1800 | 1640 |
| MDZ 8570/H | 32 | 77 | 1700 | 1540 |
| MDZ 8570/I | 32 | 77 | 1600 | 1440 |
| MDZ 8570/J | 32 | 77 | 1500 | 1340 |
| MDZ 8570/K | 32 | 77 | 1400 | 1240 |
| MDZ 8570/L | 32 | 77 | 1300 | 1140 |
| MDZ 8570/M | 32 | 77 | 1200 | 1040 |
| MDZ 8570/N | 32 | 77 | 1100 | 940 |
| MDZ 8570/O | 32 | 77 | 1000 | 840 |
| MDZ 8570/P | 32 | 77 | 900 | 740 |
| MDZ 8570/Q | 32 | 77 | 800 | 640 |
| MDZ 8570/R | 32 | 77 | 700 | 540 |
| MDZ 8570/S | 32 | 77 | 600 | 440 |
| MDZ 8570/T | 32 | 77 | 500 | 340 |
| MDZ 8570/U | 32 | 77 | 400 | 240 |

NOTE:

MDZ 8570/A to E to come with 3 stand offs (fixing points)

Special sizes available on request

Other timbers available on request



HOW TO SPECIFY

Product No. / Diameter / Projection / Finish / Fixing (refer diagram below)

eg: 8570A / 32 / 77 / SSS / TM

B = BACK TO BACK FIX

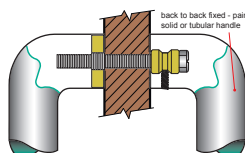

D = DISK FIX

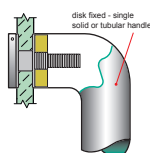

C = CONCEALED FIX

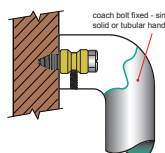

PLEASE SPECIFY DOOR TYPE

GD - Glass doors

TM - Timber doors

AL - Aluminium doors

Entry Door Pull Handle

Material 316 Marine Grade Stainless Steel
Insert Melunak (Plantation Grown Hardwood)



| Product No. | Diameter mm | Projection mm | Length mm | Fixing Centres mm |
|-------------|-------------|---------------|-----------|-------------------|
| MDZ 8575/A | 32 | 77 | 2400 | 2240 |
| MDZ 8575/B | 32 | 77 | 2300 | 2140 |
| MDZ 8575/C | 32 | 77 | 2200 | 2040 |
| MDZ 8575/D | 32 | 77 | 2100 | 1940 |
| MDZ 8575/E | 32 | 77 | 2000 | 1840 |
| MDZ 8575/F | 32 | 77 | 1900 | 1740 |
| MDZ 8575/G | 32 | 77 | 1800 | 1640 |
| MDZ 8575/H | 32 | 77 | 1700 | 1540 |
| MDZ 8575/I | 32 | 77 | 1600 | 1440 |
| MDZ 8575/J | 32 | 77 | 1500 | 1340 |
| MDZ 8575/K | 32 | 77 | 1400 | 1240 |
| MDZ 8575/L | 32 | 77 | 1300 | 1140 |
| MDZ 8575/M | 32 | 77 | 1200 | 1040 |
| MDZ 8575/N | 32 | 77 | 1100 | 940 |
| MDZ 8575/O | 32 | 77 | 1000 | 840 |
| MDZ 8575/P | 32 | 77 | 900 | 740 |
| MDZ 8575/Q | 32 | 77 | 800 | 640 |
| MDZ 8575/R | 32 | 77 | 700 | 540 |
| MDZ 8575/S | 32 | 77 | 600 | 440 |
| MDZ 8575/T | 32 | 77 | 500 | 340 |
| MDZ 8575/U | 32 | 77 | 400 | 240 |

NOTE:

MDZ 8575/A to E to come with 3 stand offs (fixing points)

Special sizes available on request

Other timbers available on request



HOW TO SPECIFY

Product No. / Diameter / Projection / Finish / Fixing (refer diagram below)

eg: 8575A / 32 / 77 / SSS / TM

B = BACK TO BACK FIX

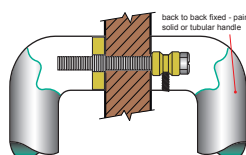

D = DISK FIX

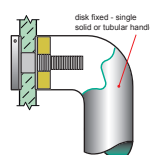

C = CONCEALED FIX

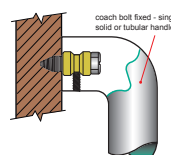

PLEASE SPECIFY DOOR TYPE

GD - Glass doors

TM - Timber doors

AL - Aluminium doors

Entry Door Pull Handle

Material 316 Marine Grade Stainless Steel



| Product No. | Fixing Centres mm | Diameter mm | Unit | Projection mm | Disc mm |
|-------------------------|-------------------|-------------|--------|---------------|---------|
| Back to Back Fix | | | | | |
| MDZ B8580 | 150 | 300 | Pair | 77 | 8 |
| MDZ B8580 | 100 | 200 | Pair | 77 | 8 |
| Disk Fix | | | | | |
| MDZ D8580 | 150 | 300 | Single | 77 | 8 |
| MDZ D8580 | 100 | 200 | Single | 77 | 8 |
| Concealed Fix | | | | | |
| MDZ C8580 | 150 | 300 | Single | 77 | 8 |
| MDZ C8580 | 100 | 200 | Single | 77 | 8 |

NOTE:
Special sizes available on request

Entry Door Pull Handle

Material 316 Marine Grade Stainless Steel



| Product No. | Fixing Centres mm | Flat Plate mm | Unit | Projection mm | Width mm | Overall Length mm |
|-------------------------|-------------------|---------------|--------|---------------|----------|-------------------|
| Back to Back Fix | | | | | | |
| MDZ B8590 | 150 | 8 | Pair | 51 | 150 | 250 |
| Disk Fix | | | | | | |
| MDZ D8590 | 150 | 8 | Single | 51 | 150 | 250 |
| Concealed Fix | | | | | | |
| MDZ C8590 | 150 | 8 | Single | 51 | 150 | 250 |



For further information please contact Madinoz.
Unit 3 / 1-7 Ada Avenue, Brookvale NSW 2100 Australia
Telephone: **(02) 9939 2007**
Facsimile: (02) 9939 8432
E-mail: sales@madinoz.com.au
Website: www.madinoz.com.au