

elite
HARDWARE

PRODUCT CATALOGUE

elite



Contact Us

Elite Hardware Ltd

Unit 4, 56 Hayton Road
(corner of Hayton Road and Dakota Crescent),
Christchurch 8042, New Zealand.

Tel: 03 348 0296

Fax: 03 348 0297

Orders: sales@elitehardware.co.nz

Admin: admin@elitehardware.co.nz

www.elitehardware.co.nz

About Us

Elite Hardware is a New Zealand owned and operated company supplying kitchen and furniture hardware with the main emphasis on cabinet handles. We pride ourselves in providing excellent knowledgeable service and quality products at competitive rates.

Our products are imported directly to our Christchurch warehouse. The majority of these products are unique to Elite Hardware.

The full range of these products can also be viewed online on our website www.elitehardware.co.nz



Installation Warning

After purchasing handles from Elite Hardware Ltd, please check that you have the correct size and finish.

Elite Hardware Ltd will not be held responsible for incorrect hole drilling and fitting.

Finishes can vary slightly between shipments.

Photos in this catalogue are as close to the finished product as possible.

Colour shades can vary due to printing process.

All handles are guaranteed against faulty workmanship.

Products are subject to change.















Elite Hardware Ltd holds no responsibility for any errors shown in this publication.

All measurements are in millimetres unless otherwise stated.

contact us



Handles

Elite Black & Gunmetal Handles	3	
Elite Modern Handles	13	
Elite Chrome Handles	25	
Elite Dee and Bow Handles	29	
Elite Knobs	33	
Elite Classical Collection	39	
Elite Overlay & Strip Handles	47	
Elite Inset Handles	53	
Elite Lumina Lighting Extrusions	57	
Elite Extrusion Handles	61	
Elite Wardrobe Fittings	65	
Italiana Ferramenta Hardware	71	
Elite Legs & Towel Rails	75	
Index	79	

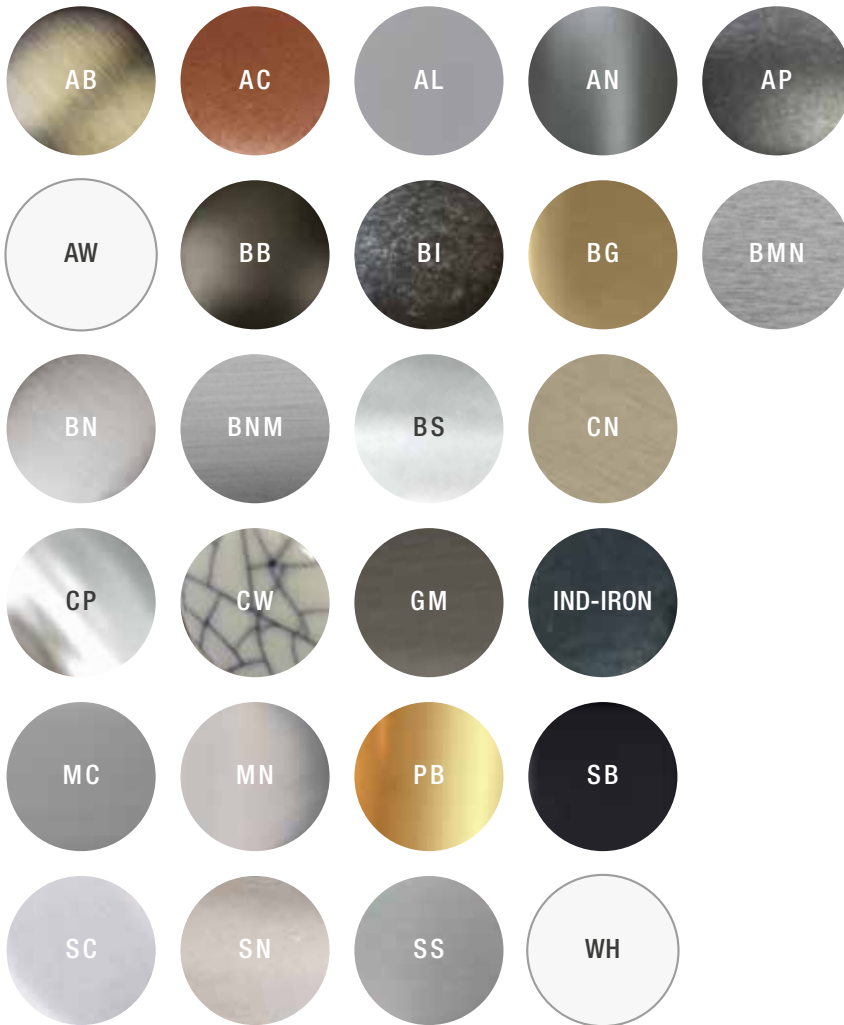

Finish Information

Antique Bronze	AB
Antique Copper	AC
Aluminium	AL
Anthracite	AN
Antique Pewter	AP
Arctic White	AW
Bronze Black	BB
Brushed Gold	BG
Black Iron	BI
Brushed Matt Nickel	BMN
Brushed Nickel	BN
Brushed Nickel Matt	BNM
Brushed Silver	BS
Champagne Nickel	CN
Chrome Plated	CP
Crazed White	CW
Gunmetal	GM
Industrial Iron	IND-IRON
Matt Chrome	MC
Mirror Nickel	MN
Polished Brass	PB
Satin Black	SB
Satin Chrome	SC
Satin Nickel	SN
Stainless Steel	SS
White	WH

Please Note

Brushed Nickel Matt - Fine Brushing
 Brushed Matt Nickel - Medium Brushing



elite black & gunmetal handles

Tuba

Code	Finish	CC	Length	Height	Width
2221	BB	128	152	24	24



Maia

Code	Finish	CC	Length	Height	Width
2238	BB	128	159	29	14



Neo

Code	Finish	CC	Length	Height	Width
2240	BB	128	159	27	20



Siena

Code	Finish	CC	Length	Height	Width
2908	SB	128	136	24	13



Alba

Code	Finish	CC	Length	Height	Width
2918	SB	128	198	29	24

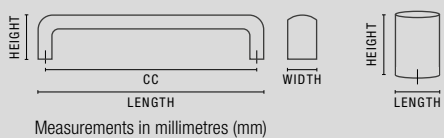

Tom Flat Bow

Code	Finish	CC	Length	Height	Width
3077	SB	128	141	32	15



Traditional Bar

Code	Finish	CC	Length	Height	Width
3809	GM	128	143	33	13
3810	GM	160	175	33	13
3811	GM	224	239	33	13
3812	GM	256	271	33	13



Inspire

Code	Finish	CC	Length	Height	Width
4000	SB	32	39	32	8.5
4001	SB	128	135	32	8.5
4002	SB	160	167	32	8.5
4003	SB	320	329	32	8.5
4004	AN	32	39	32	8.5
4005	AN	128	135	32	8.5
4006	AN	160	167	32	8.5
4007	AN	320	329	32	8.5



Lorenzo

Code	Finish	CC	Length	Height	Width
4030	SB	128	136	25	12
4034	SB	160	168	25	12
4036	SB	256	264	25	12



Micala

Code	Finish	CC	Length	Height	Width
4704	SB	160	174	30	13



Louissette

Code	Finish	CC	Length	Height	Width
4811	SB	160/192	212	24	15



Romana

Code	Finish	CC	Length	Height	Width
5710	SB	128	164	25	21
5711	SB	192	228	25	21
5712	SB	256	292	25	21
5713	SB	320	356	25	21
5815	GM	128	164	25	21
5816	GM	192	228	25	21
5817	GM	256	292	25	21
5818	GM	320	356	25	21



Metropolis

Code	Finish	CC	Length	Height	Width
6160	GM	160	167	23	18



Catalina

Code	Finish	CC	Length	Height	Width
6238	SB	128	137	34	12
6229	SB	160	170	34	12
6239	SB	256	265	34	12
6240	SB	320	329	34	12



Viola

Code	Finish	CC	Length	Height	Width
6705	SB	128	136	26	16
6706	SB	160	168	29	20
6707	SB	192	200	29	20
6708	SB	256	264	29	20
6719	SB	320	328	29	20
6722	SB	416	424	29	22

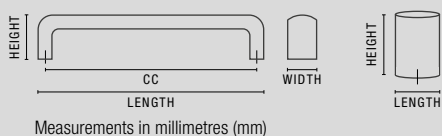

Malaga

Code	Finish	CC	Length	Height	Width
6759	SB	160	190	30	22



Kara Slim Square

Code	Finish	CC	Length	Height	Width
6941	SB	128	154	27	8
6942	SB	160	192	27	8
6943	SB	256	292	27	8
6945	SB	320	356	27	8



Contemporary Handle

Code	Finish	CC	Length	Height	Width
7011	SB	160	174	21	21
7012	SB	224	238	21	21



Estela

Code	Finish	CC	Length	Height	Width
7112	SB	160	178	27.5	18



Contemporary Knob

Code	Finish	Height	Width
2217	SB	27	28





Contact Us

Elite Hardware Ltd

Unit 4, 56 Hayton Road
(corner of Hayton Road and Dakota Crescent),
Christchurch 8042, New Zealand.

Tel: 03 348 0296

Fax: 03 348 0297

Orders: sales@elitehardware.co.nz

Admin: admin@elitehardware.co.nz

www.elitehardware.co.nz

About Us

Elite Hardware is a New Zealand owned and operated company supplying kitchen and furniture hardware with the main emphasis on cabinet handles. We pride ourselves in providing excellent knowledgeable service and quality products at competitive rates.

Our products are imported directly to our Christchurch warehouse. The majority of these products are unique to Elite Hardware.

The full range of these products can also be viewed online on our website www.elitehardware.co.nz



Installation Warning

After purchasing handles from Elite Hardware Ltd, please check that you have the correct size and finish.

Elite Hardware Ltd will not be held responsible for incorrect hole drilling and fitting.

Finishes can vary slightly between shipments.

Photos in this catalogue are as close to the finished product as possible.

Colour shades can vary due to printing process.

All handles are guaranteed against faulty workmanship.

Products are subject to change.

Elite Hardware Ltd holds no responsibility for any errors shown in this publication.

All measurements are in millimetres unless otherwise stated.

contact us

Kingston Pull

Code	Finish	CC	Length	Height	Width
3841	Black	128	133	41	20



Kingston Drop

Code	Finish	CC	Length	Height
3842	Black	160	180	22



Florentine Knob

Code	Finish	Length	Height	Width
3820B	SB	65	32	21



Florentine Pull

Code	Finish	CC	Length	Height	Width
3821B	SB	128	145	35	21



Versailles Cup Handle

Code	Finish	CC	Length	Height
2050	SB	64	103	27



Georgia Cup Handle

Code	Finish	CC	Length	Height
2058	SB	64	96	39



Overlay Pull

Code	Finish	CC	Length
2065	SB	128	168
2073	SB	192	233



Kasia Pull

Code	Finish	CC	Length
4732	SB	64	104
4734	SB	128	168
4736	SB	192	232

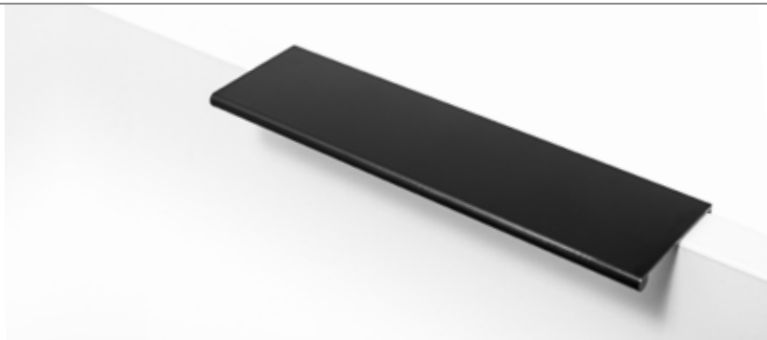

Lorette Overlay Pull

Code	Finish	CC	Length
4802	SB		51

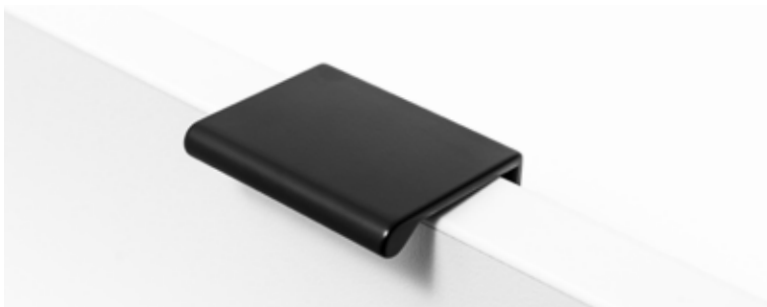

Lucia Pull

Code	Finish	CC	Length	Height	Width
6776	SB	32	52	16	41
6778	SB	50	70	16	41
6779	SB	128	148	16	41
6780	SB	256	276	16	41
6782	GM	32	52	16	41
6783	GM	50	70	16	41
6784	GM	128	148	16	41
6785	GM	256	276	16	41

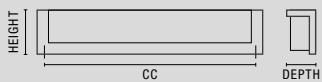

Measurements in millimetres (mm)

Aurora Pull

Code	Finish	CC	Length	Height	Width
6510	SB		298	18	40.5
6511	SB		398	18	40.5
6512	SB		448	18	40.5
6513	SB		498	18	40.5
6515	SB		598	18	40.5
6516	SB		698	18	40.5
6517	SB		798	18	40.5
6519	SB		898	18	40.5
6520	SB		998	18	40.5



Cordoba Pull

Code	Finish	CC	Length	Height	Width
8800	SB	16	33	20	15
8801	SB	160	177	20	15
8803	SB	256	273	20	15



Oriane Inset Handle

Code	Finish	CC	Length	Height	Depth
4816	SB	128	149		13.5

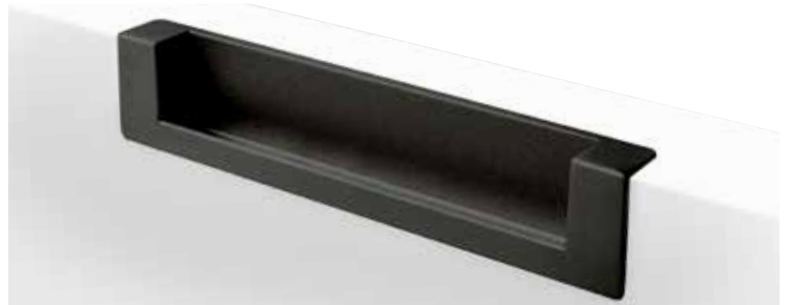

Ultimate Inset

Code	Finish	Length	Height	Depth
6226	GM	202	50	16

For use with painted doors

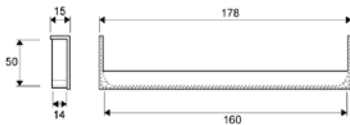

Elite Inset

Code	Finish	CC	Length	Depth
7761	SB	128	134	17
7762	SB	192	198	17

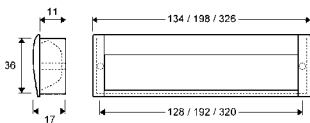

Apollo Centre Profile

Code	Finish	Length	Height	Board Width
8882	SB	3m	56	19

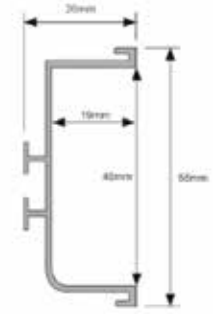

Apollo Top Profile

Code	Finish	Length	Height	Board Width
8884	SB	3m	44	19

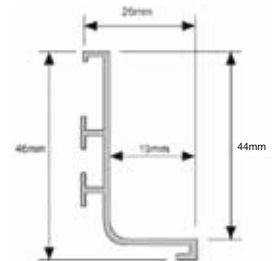

Novara G Profile

Code	Finish	Length	Height	Board Width
8899	SB	3m	35	18

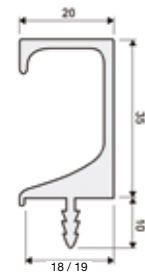

Allegra G Profile with End Caps

Code	Finish	Length	Height	Board Width
8702	SB	3m	35	18
8692	SB	End Caps Pair		

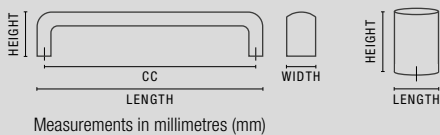
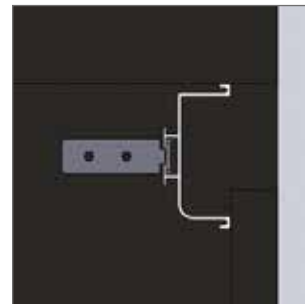
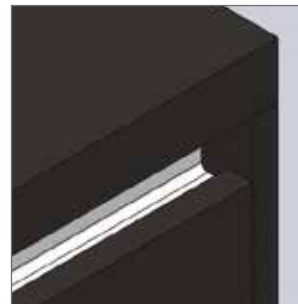
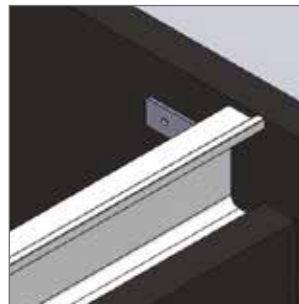
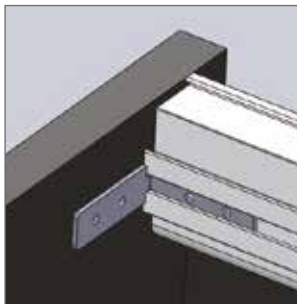



elite modern handles

Tuba

Code	Finish	CC	Length	Height	Width
2229	BNM	128	152	24	24



Siena

Code	Finish	CC	Length	Height	Width
2906	BN	128	136	24	13
2908	SB	128	136	24	13



Alessia

Code	Finish	CC	Length	Height	Width
2912	BN	128	166	32	24



Alba

Code	Finish	CC	Length	Height	Width
2915	BN	128	198	29	24
2917	CP				

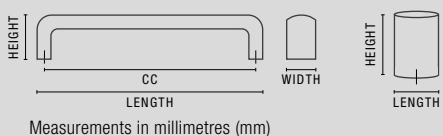

Lorenzo

Code	Finish	CC	Length	Height	Width
3026	BN	96	104	25	12
3030	BN	128	136	25	12
3034	BN	160	168	25	12
3993	BN	192	201	25	12
3995	BN	256	264	25	12
3999	BN	288	296	25	12
3031	MC	96	104	25	12
3032	MC	128	136	25	12
3033	MC	160	168	25	12
3997	MC	256	264	25	12
4030	SB	128	136	25	12
4034	SB	160	168	25	12
4036	SB	256	264	25	12



Ultimate Wide Square

Code	Finish	CC	Length	Height	Width
3991	BN	128	136	25	22
3994	BN	160	168	25	22
3996	BN	224	232	25	22
3998	BN	288	296	25	22



Inspire

Code	Finish	CC	Length	Height	Width
4000	SB	32	39	32	8.5
4001	SB	128	135	32	8.5
4002	SB	160	167	32	8.5
4003	SB	320	329	32	8.5
4004	AN	32	39	32	8.5
4005	AN	128	135	32	8.5
4006	AN	160	167	32	8.5
4007	AN	320	329	32	8.5
4008	BG	32	39	32	8.5
4009	BG	128	135	32	8.5
4010	BG	160	167	32	8.5
4011	BG	320	329	32	8.5
4012	BN	32	39	32	8.5
4013	BN	128	135	32	8.5
4014	BN	160	167	32	8.5
4015	BN	320	329	32	8.5



V Base Square

Code	Finish	CC	Length	Height	Width
4252	BN	160	170	30	22
4253	BN	224	239	30	22
4255	BN	320	334	30	22



Lia

Code	Finish	CC	Length	Height	Width
4331	BN	128	136	30	8
4332	BN	192	200	30	8
4333	BN	320	328	30	8
4339	BN	492	500	30	8
4334	MC	128	136	30	8
4335	MC	192	200	30	8
4336	MC	320	328	30	8
4340	MC	492	500	30	8
4337	CP	128	136	30	8
4338	CP	192	200	30	8



Micala

Code	Finish	CC	Length	Height	Width
4701	BNM	160	174	30	13
4702	PB	160	174	30	13
4703	AC	160	174	30	13
4704	SB	160	174	30	13

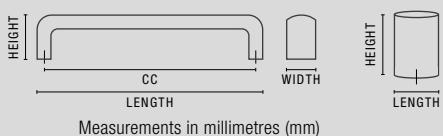

Louissette

Code	Finish	CC	Length	Height	Width
4810	BN	160/192	212	24	15
4811	SB	160/192	212	24	15
4812	AB	160/192	212	24	15



Violetta

Code	Finish	CC	Length	Height	Width
5805	BNM	128	157	20	10
5806	BNM	192	208	20	10
5807	BNM	224	252	20	10
5808	BNM	320	348	20	10



Romana

Code	Finish	CC	Length	Height	Width
5710	SB	128	164	25	21
5711	SB	192	228	25	21
5712	SB	256	292	25	21
5713	SB	320	356	25	21
5810	BNM	128	164	25	21
5811	BNM	192	228	25	21
5812	BNM	256	292	25	21
5813	BNM	320	356	25	21
5814	MC	128	164	25	21
5815	GM	128	164	25	21
5816	GM	192	228	25	21
5817	GM	256	292	25	21
5818	GM	320	356	25	21



Bar Handle

Code	Finish	CC	Length	Height	Width
6010	BN	96	136	36	12
6020	BN	128	168	36	12
6030	BN	160	200	36	12
6040	BN	192	232	36	12
6050	BN	288	328	36	12
6060	BN	448	488	36	12



Metropolis

Code	Finish	CC	Length	Height	Width
6157	BN	160	167	23	18
6158	BN	192	199	25	18
6160	GM	160	167	23	18



Giovanna

Code	Finish	CC	Length	Height	Width
6171	BNM	128	164	28	12
6172	BNM	192	239	28	12
6173	BNM	256	303	28	12
6174	BNM	320	367	28	12



Milan Square

Code	Finish	CC	Length	Height	Width
6194	BN	160	168	22	18
6195	BN	192	200	24	18
6196	BN	256	264	26	18

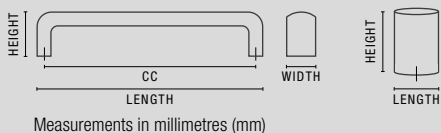

Alanzo

Code	Finish	CC	Length	Height	Width
6197	BNM	128	140	28	13
6199	BNM	160	172	28	13



Catalina

Code	Finish	CC	Length	Height	Width
6231	BNM	128	137	34	12
6228	BNM	160	170	34	12
6232	BNM	256	265	34	12
6233	BNM	320	329	34	12
6238	SB	128	137	34	12
6229	SB	160	170	34	12
6239	SB	256	265	34	12
6240	SB	320	329	34	12



Giorgio Flat Cross Bar

Code	Finish	CC	Length	Height	Width
6432	MC	128	140	35	16
6434	MC	160	172	35	16
6435	MC	224	236	35	16
6436	MC	288	300	35	16
6438	MC	448	460	35	16
6440	MC	544	556	35	16
6442	MC	736	748	35	16
6551	BN	96	108	35	16
6552	BN	128	140	35	16
6553	BN	160	172	35	16
6550	BN	224	236	35	16
6548	BN	256	268	35	16
6554	BN	288	300	35	16
6549	BN	320	332	35	16
6555	BN	448	460	35	16
6556	BN	544	556	35	16
6557	BN	650	662	35	16
6559	BN	728	740	35	16



Alena

Code	Finish	CC	Length	Height	Width
6571	BNM	128	237	32	8.5
6572	BNM	192	301	32	8.5
6573	BNM	256	365	32	8.5
6574	BNM	320	429	32	8.5



Arelia

Code	Finish	CC	Length	Height	Width
6663	MC	128	162	27	24
6664	MC	192	227	27	24



Viola

Code	Finish	CC	Length	Height	Width
6701	BNM	128	136	26	16
6702	BNM	160	168	29	20
6703	BNM	192	200	29	20
6704	BNM	256	264	29	20
6718	BNM	320	328	29	20
6721	BNM	416	424	29	22
6705	SB	128	136	26	16
6706	SB	160	168	29	20
6707	SB	192	200	29	20
6708	SB	256	264	29	20
6719	SB	320	328	29	20
6722	SB	416	424	29	22
6709	AC	128	136	26	16
6710	AC	160	168	29	20
6711	AC	192	200	29	20
6712	AC	256	264	29	20
6720	AC	320	328	29	20
6723	AC	416	424	29	22
6724	BG	128	136	26	16
6725	BG	160	168	29	20
6726	BG	192	200	29	20
6727	BG	256	264	29	20

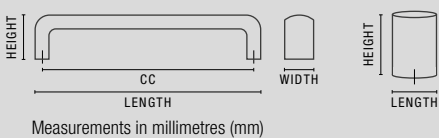

Malaga

Code	Finish	CC	Length	Height	Width
6758	SN	160	190	30	22
6759	SB	160	190	30	22



Kara Slim Square

Code	Finish	CC	Length	Height	Width
6885	BN	96	126	27	8
6886	BN	128	155	27	8
6888	BN	160	192	27	8
6889	BN	192	220	27	8
6906	BN	256	292	27	8
6908	BN	320	356	27	8
6910	BG	128	155	27	8
6911	BG	160	192	27	8
6912	BG	256	292	27	8
6991	MC	96	113	27	8
6992	MC	128	154	27	8
6993	MC	160	192	27	8
6907	MC	256	292	27	8
6909	MC	320	356	27	8
6941	SB	128	154	27	8
6942	SB	160	192	27	8
6943	SB	256	292	27	8
6945	SB	320	356	27	8



Vibe

Code	Finish	CC	Length	Height	Width
6920	BMN	160	188	34	9
6921	BMN	192	220	34	9
6922	BMN	224	252	34	9
6923	BMN	256	284	34	9
6924	BMN	320	348	34	9
6926	BMN	448	476	34	9
6928	BMN	544	572	34	9
6930	BMN	672	700	34	9



Gabi Cross Bar 16mm

Code	Finish	CC	Length	Height	Width
7001	BN	128	140	41	16
7002	BN	160	172	41	16
7003	BN	192	204	41	16
7004	BN	224	236	41	16
7005	BN	288	300	41	16
7006	BN	352	364	41	16
7007	BN	448	460	41	16
7008	BN	544	556	41	16



Mario

Code	Finish	CC	Length	Height	Width
7030	BN	128	146	32	15
7031	BN	224	242	32	15



Contemporary Handle

Code	Finish	CC	Length	Height	Width
7011	SB	160	174	21	21
7012	SB	224	238	21	21
7013	AP	160	174	21	21
7014	AP	224	238	21	21
7016	BI	160	174	21	21
7017	BI	224	238	21	21
7021	MC	128	142	21	21
7025	MC	160	174	21	21
7026	MC	224	238	21	21
7028	MC	256	270	21	21
7022	BN	128	142	21	21
7023	BN	160	174	21	21
7024	BN	224	238	21	21
7027	BN	256	270	21	21



Estela

Code	Finish	CC	Length	Height	Width
7110	BMN	160	178	27.5	18
7111	BI	160	178	27.5	18
7112	SB	160	178	27.5	18

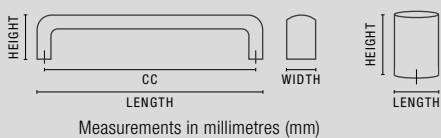

Amelia Cross Bar 14mm

Code	Finish	CC	Length	Height	Width
7201	BN	128	149	36	14
7202	BN	160	181	36	14
7203	BN	192	213	36	14
7204	BN	224	245	36	14
7205	BN	352	373	36	14
7207	BN	544	565	36	14



Amelia Cross Bar 14mm - Parts

Code	Finish	Part	Length	Height	Width
7208	BN	Foot	22	36	14
7209	BN	Bar	825		14

Bar can be cut down to make customised handles



Contemporary Square

Code	Finish	CC	Length	Height	Width
7280	SS	128	142	42	15
7281	SS	160	174	42	15
7283	SS	256	270	42	15
7285	SS	320	334	42	15
7287	SS	448	472	42	15



Gabi Cross Bar 12mm

Code	Finish	CC	Length	Height	Width
7301	SS	128	148	36	12
7303	SS	192	212	36	12
7305	SS	288	308	36	12
7306	SS	384	404	36	12



Amelia Cross Bar 10mm

Code	Finish	CC	Length	Height	Width
7310	BN	128	149	38	10
7311	BN	160	181	38	10
7312	BN	192	213	38	10
7313	BN	288	308	38	10
7314	BN	384	405	38	10
7315	BN	544	565	38	10



Designer Wide Square

Code	Finish	CC	Length	Height	Width
7440	BMN	128	160	27	25
7441	BMN	160	192	27	25
7443	BMN	224	256	27	25
7444	BMN	256	288	27	25
7446	BMN	320	352	27	25
7448	BMN	448	480	27	25



Designer Slim Square

Code	Finish	CC	Length	Height	Width
7450	BMN	160	210	30	9
7451	BMN	192	242	30	9
7452	BMN	224	274	30	9
7453	BMN	256	306	30	9
7454	BMN	320	370	30	9
7455	BMN	384	434	30	9
7457	BMN	480	530	30	9
7460	MC	160	210	30	9
7461	MC	192	242	30	9
7463	MC	256	306	30	9
7465	MC	384	434	30	9
7470	CP	160	210	30	9
7472	CP	256	306	30	9
7474	CP	384	434	30	9



Modular Handle

Code	Finish	CC	Length	Height	Width
7481	BNM	160	188	35	16
7483	BNM	224	252	35	16
7484	BNM	256	284	35	16
7486	BNM	320	348	35	16
7488	BNM	448	476	35	16
7490	BNM	650	678	35	16



Cube Cross Bar

Code	Finish	CC	Length	Height	Width
7560	MC	128	150	38	15
7562	MC	192	214	38	15
7563	MC	256	278	38	15
7565	MC	352	374	38	15
7567	MC	544	566	38	15

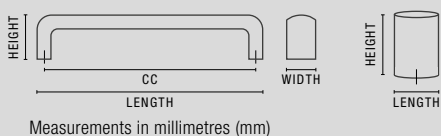



elite chrome

Alba

Code	Finish	CC	Length	Height	Width
2917	CP	128	198	25	24



Big Bow

Code	Finish	CC	Length	Height	Width
3899	CP	128	145	29	10



Lia

Code	Finish	CC	Length	Height	Width
4337	CP	128	136	30	8
4338	CP	192	200	30	8



Contemporary Handle

Code	Finish	CC	Length	Height	Width
7018	CP	160	238	21	21



Designer Bow

Code	Finish	CC	Length	Height	Width
7052	CP	96	138	24	15

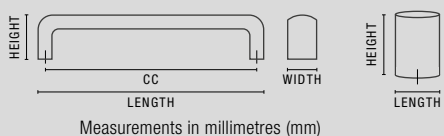

Designer Slim Square

Code	Finish	CC	Length	Height	Width
7470	CP	160	210	30	9
7472	CP	256	306	30	9
7474	CP	384	436	30	9



Sara

Code	Finish	Length	Height	Width
1854	CP	12	25	12



Adella

Code	Finish	Length	Height	Width
2028	CP	44	18	20

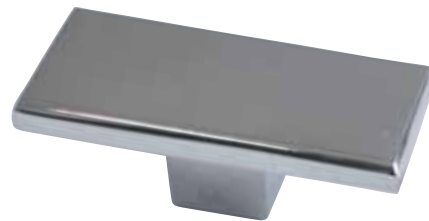

Florenza

Code	Finish	Length	Height	Width
2101	CP	31	27.5	31



Contemporary Knob

Code	Finish	Height	Width
2218	CP	27	28



Classic Knob

Code	Finish	Length	Height	Width
3793	CP	33	25	33



Metro

Code	Finish	CC	Length	Height	Width
6205	CP	32	71	21	18



Versailles Cup Handle

Code	Finish	CC	Length	Height
2052	CP	64	103	27



Georgia Cup Handle

Code	Finish	CC	Length	Height
2054	CP	64	96	39



Romola Reverse Inset

Code	Finish	Length	Height	Depth
6224	CP	195	18	18

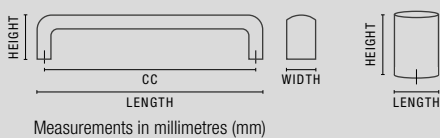



elite dee & bow handles

D Handle

Code	Finish	CC	Length	Height	Width
1268	MC	96	106	35	10
1269	MC	128	138	35	10
1290	BN	96	106	35	10
1270	BN	128	138	35	10
1275	BN	160	170	35	10
1277	BN	256	266	35	10
1278	BN	320	330	35	10



Nova

Code	Finish	CC	Length	Height	Width
3003	BN	128	184	24	21
3004	MC	128	184	24	15



Twist Bow

Code	Finish	CC	Length	Height	Width
3005	BN	128	168	30	16
3007	MC	128	168	30	16



Slim Bow

Code	Finish	CC	Length	Height	Width
3020	BN	96	114	23	10
3028	BN	128	145	23	10
3027	MC	96	114	23	10
3029	MC	128	145	23	10



Standard Bow

Code	Finish	CC	Length	Height	Width
3035	BN	96	115	31	10
3036	BN	128	155	31	10
3037	MC	96	115	30	10
3038	MC	128	155	30	10

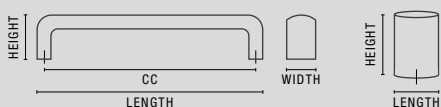

Capri

Code	Finish	CC	Length	Height	Width
3050	BN	96	121	22	12
3055	BN	128	156	22	12
3059	BN	192	220	22	12
3060	BN	320	350	22	12
3057	MC	128	156	22	12



Tom Flat Bow

Code	Finish	CC	Length	Height	Width
3072	BN	96	105	32	15
3075	BN	128	141	32	15
3076	MC	128	141	32	15
3077	SB	128	141	32	15



Josh Wide Bow

Code	Finish	CC	Length	Height	Width
3082	BN	96	105	27	19
3084	BN	128	141	27	19



Big Bow

Code	Finish	CC	Length	Height	Width
3899	CP	128	145	26	10
3900	BN	128	145	26	10
3901	MC	128	145	26	10
3902	SN	128	145	26	10



Designer Bow

Code	Finish	CC	Length	Height	Width
7050	BN	96	138	24	15
7081	BN	192	249	24	15
7052	CP	96	138	24	15
7057	MC	96	138	24	15
7082	MC	192	249	24	15

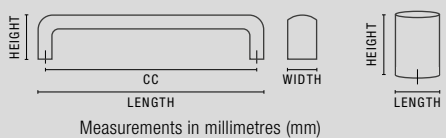

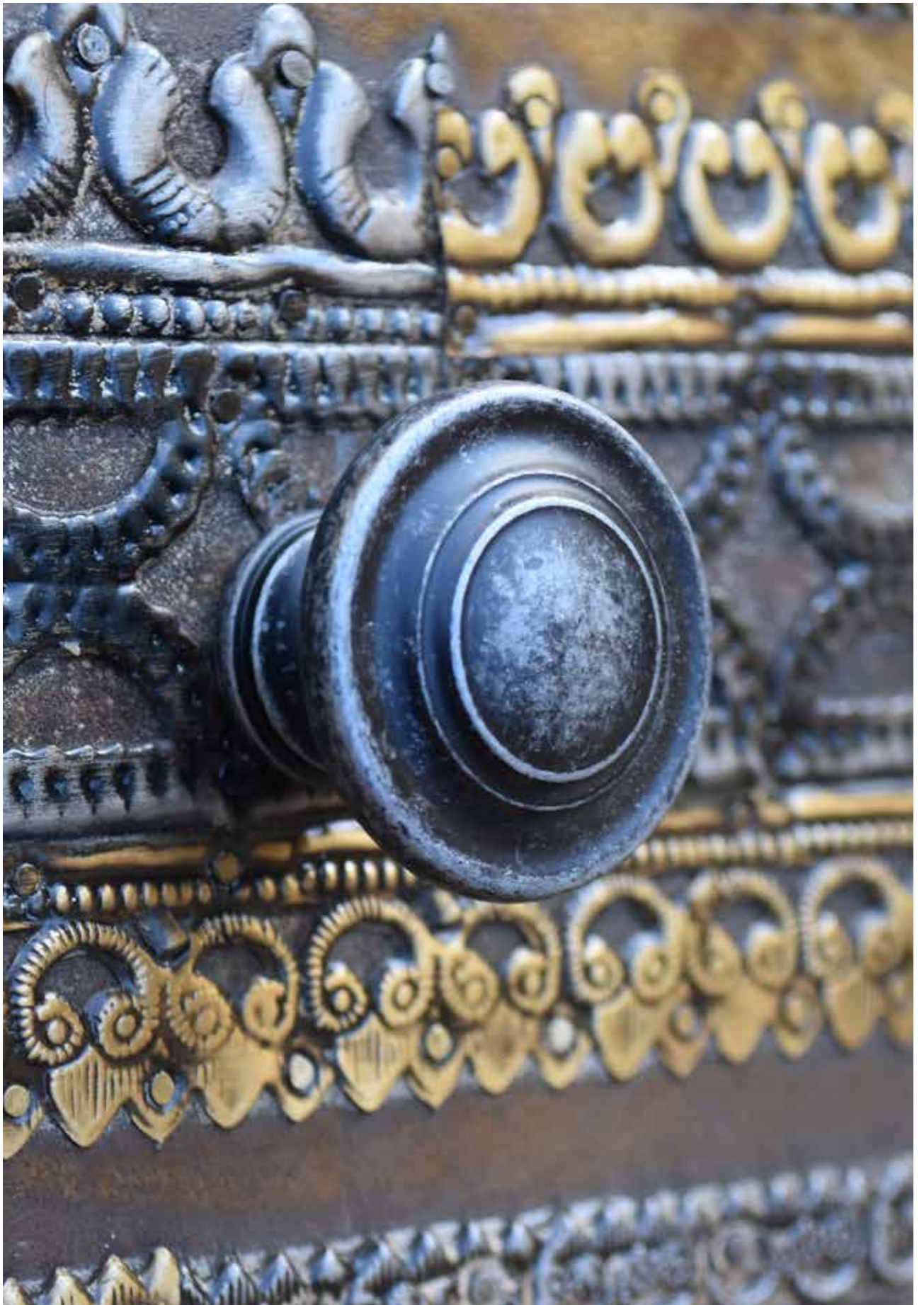

elite knobs

Rosa

Code	Finish	Height	Width
1840	MC	30	25



Primo

Code	Finish	Height	Width
1846	SS	24	18
1847	SS	31	25



Sara

Code	Finish	Height	Width
1852	MC	25	12
1853	BN	25	12
1854	CP	25	12



Alisa

Code	Finish	Height	Width
1998	BN	27	25
1999	MC	27	25



Carrado

Code	Finish	CC	Length	Height	Width
2002	BN	16	25	21	25
2004	MC	16	25	21	25

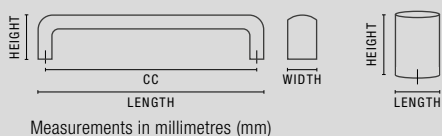

Kira Knob

Code	Finish	Height	Width
2020	BN	29	30
2420	BNM	29	30
2421	PB	29	30
2422	AC	29	30



Adella

Code	Finish	Length	Height	Width
2025	BN	44	18	20
2027	MC	44	18	20
2028	CP	44	18	20



Enzo

Code	Finish	Height	Width
2033	BN	28	35
2034	MC	28	35



Michelle Square Knob

Code	Finish	CC	Length	Height	Width
2071	BN	16	36	21	36
2072	MC	16	36	21	36



Klara

Code	Finish	Length	Height	Width
2075	BN	30	16	13
2076	MC	30	16	13



Florenza

Code	Finish	Height	Width
2100	GM	27.5	31
2101	CP	27.5	31
2102	BN	27.5	31
2103	AB	27.5	31
2104	SC	27.5	31



Cino

Code	Finish	Height	Width
2117	MC	28	31
2119	BN	28	31



Contemporary Knob

Code	Finish	Height	Width
2214	BI	27	28
2215	AP	27	28
2216	BB	27	28
2217	SB	27	28
2218	CP	27	28
2219	BN	27	28



BI

Tuba Knob

Code	Finish	Length	Height	Width
2223	BB	28	27	28
2226	BI	28	27	28
2227	BNM	28	27	28



Classic Knob

Code	Finish	Height	Width
3793	CP	25	33
3797	AC	25	33
3798	SB	25	33
3801	AP	25	33
3802	BI	25	33
3803	BN	25	33
3804	AB	25	33



AP

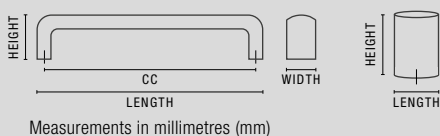

Inspire Knob

Code	Finish	CC	Length	Height	Width
4000	SB	32	39	32	8.5
4004	NBG	32	39	32	8.5
4008	BG	32	39	32	8.5
4012	BN	32	39	32	8.5



Metro

Code	Finish	CC	Length	Height	Width
6205	CP	32	71	21	18
6206	BN	32	71	21	18
6207	MC	32	71	21	18



Stasya

Code	Finish	CC	Length	Height	Width
6208	BN	32	66	27	12



Viola Knob

Code	Finish	Length	Height	Width
6715	BNM	34	30	22
6716	SB	34	30	22
6717	AC	34	30	22



Cordoba Pull

Code	Finish	CC	Length	Height	Width
8800	SB	16	33	20	15
8795	SN	16	33	20	15





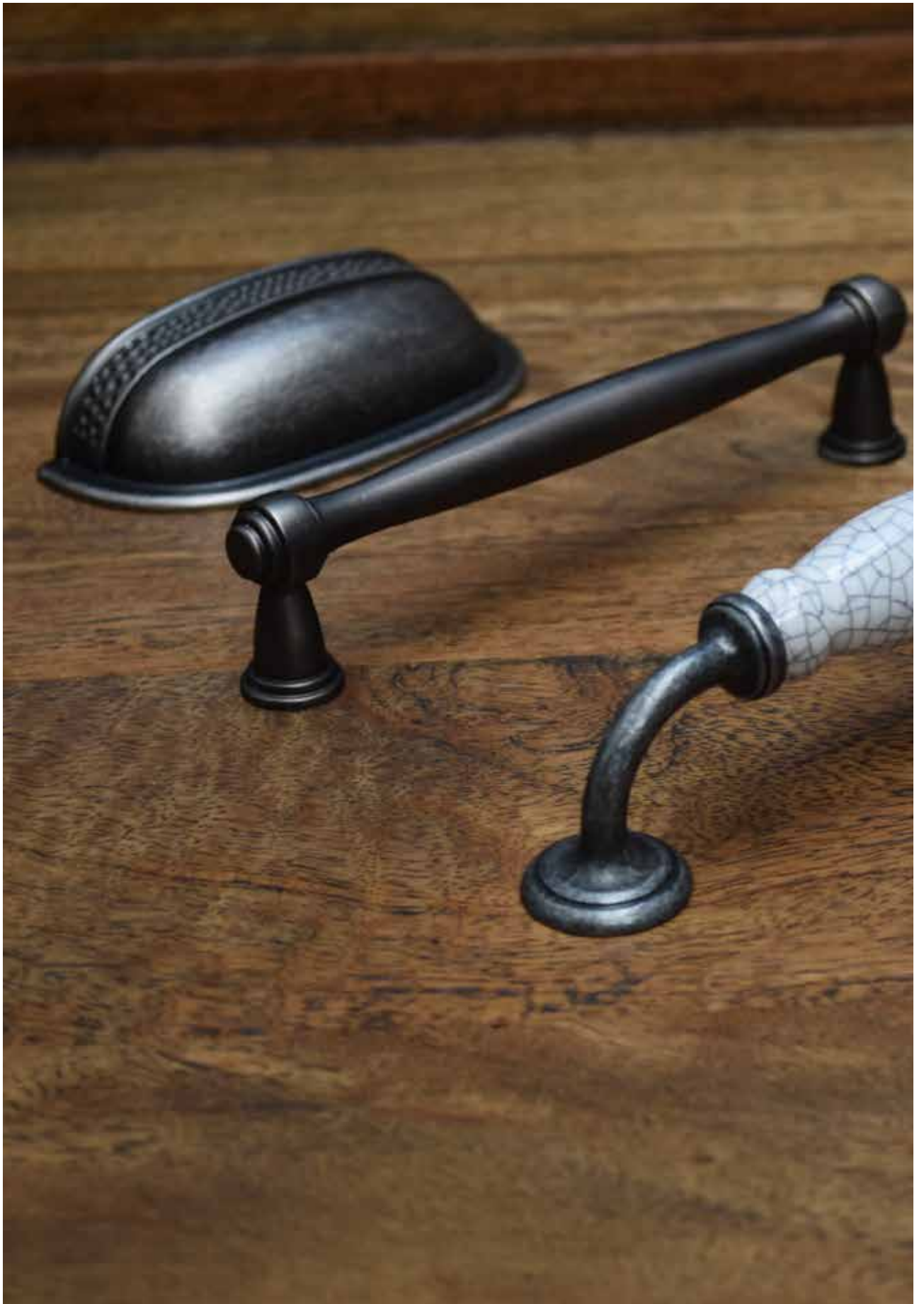

elite classical collection

Ainsley

Code	Finish	Length	Height	Width
1855	AP	30	22	30
1856	BN	30	22	30
1857	AB	30	22	30



Bristol

Code	Finish	Length	Height	Width
1860	AP	30	22	30
1861	AB	30	22	30



Montclair Knob

Code	Finish	Length	Height	Width
2046	BI	33	33	31
2055	AB	33	33	31



Montclair Cup Handle

Code	Finish	CC	Length	Height	Width
2056	BI	76	99	27	41.5
2057	AB	76	99	27	41.5



Florenza

Code	Finish	Height	Width
2100	GM	27.5	31
2101	CP	27.5	31
2102	BN	27.5	31
2103	AB	27.5	31
2104	SC	27.5	31

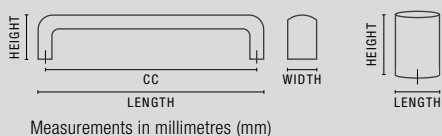

Classic Knob

Code	Finish	Length	Height	Width
3793	CP	33	25	33
3797	AC	33	25	33
3798	SB	33	25	33
3801	AP	33	25	33
3802	BI	33	25	33
3803	BN	33	25	33
3804	AB	33	25	33



AP



Tuba Knob

Code	Finish	Length	Height	Width
2223	BB	28	27	28
2226	BI	28	27	28
2227	BNM	28	27	28



Tuba

Code	Finish	CC	Length	Height	Width
2221	BB	128	152	24	24
2224	BI	128	152	24	24
2229	BNM	128	152	24	24



Florentine Knob

Code	Finish	Length	Height	Width
3825	AB	65	32	21
3820B	SB	65	32	21
3820D	BI	65	32	21
3820P	AP	65	32	21



Florentine Pull

Code	Finish	CC	Length	Height	Width
3821P	AP	128	145	35	21
3821B	SB	128	145	35	21
3826	AB	128	145	35	21
3821D	BI	128	145	35	21



Florentine Drop

Code	Finish	CC	Length	Width
3822D	BI	160	188	21
3827	AB	160	188	21



Versailles Cup Handle

Code	Finish	CC	Length	Height
2039	BI	64	103	27
2048	AP	64	103	27
2050	SB	64	103	27
2051	AB	64	103	27
2052	CP	64	103	27



Georgia Cup Handle

Code	Finish	CC	Length	Height
2058	SB	64	96	39
2054	CP	64	96	39
2059	BN	64	96	39

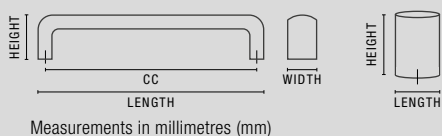

Kingston Pull

Code	Finish	CC	Length	Height	Width
3841	Black	128	133	41	20



Kingston Drop

Code	Finish	CC	Length	Height
3842	Black	160	180	22



Neo

Code	Finish	CC	Length	Height	Width
2240	BB	128	159	27	20



Maia

Code	Finish	CC	Length	Height	Width
2238	BB	128	159	29	14



Juliet Knob

Code	Finish	Length	Height	Width
1865	AB / Crazed Cream	28	24	28



Juliet Pull

Code	Finish	CC	Length	Height	Width
1559	AB / Crazed Cream	128	140	40	22



Nicollet

Code	Finish	Length	Height	Width
3830	AP / Crazed White	85	42	27



Maddison Knob

Code	Finish	Length	Height	Width
3837	White	30	30	32
3850	CP / White	32	27	32



Maddison Pull

Code	Finish	CC	Length	Height	Width
3834	CP / White	128	152	40	23

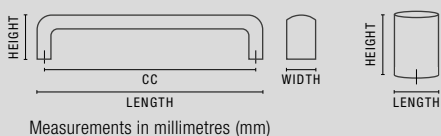

Newport Knob

Code	Finish	Length	Height	Width
3831	Crazed White SQ	38	26	38
3835	AP / Crazed White	32	27	32
3836	Crazed White RND	32	30	32



Newport T Knob

Code	Finish	Length	Height	Width
3829	AP / Crazed White	74	40	23



Newport Pull

Code	Finish	CC	Length	Height	Width
3832	AP / Crazed White	128	152	40	23



Newport Drop

Code	Finish	CC	Length	Height	Width
3833	AP / Crazed White	160	175	23	23



Contemporary Knob

Code	Finish	Length	Height	Width
2214	BI	27	27	27
2215	AP	27	27	27
2216	BB	27	27	27



Contemporary Handle

Code	Finish	CC	Length	Height	Width
7011	SB	160	174	21	21
7012	SB	224	238	21	21
7013	AP	160	174	21	21
7014	AP	224	238	21	21
7016	BI	160	174	21	21
7017	BI	224	238	21	21



Traditional Knob

Code	Finish	Length	Height	Width
3814	IND-IRON	28	22	28
3815	GM	28	22	28



Traditional Bar

Code	Finish	CC	Length	Height	Width
3805	IND-IRON	128	143	33	13
3806	IND-IRON	160	175	33	13
3807	IND-IRON	224	239	33	13
3808	IND-IRON	256	271	33	13
3809	GM	128	143	33	13
3810	GM	160	175	33	13
3811	GM	224	239	33	13
3812	GM	256	271	33	13

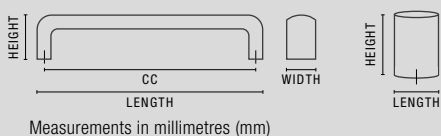

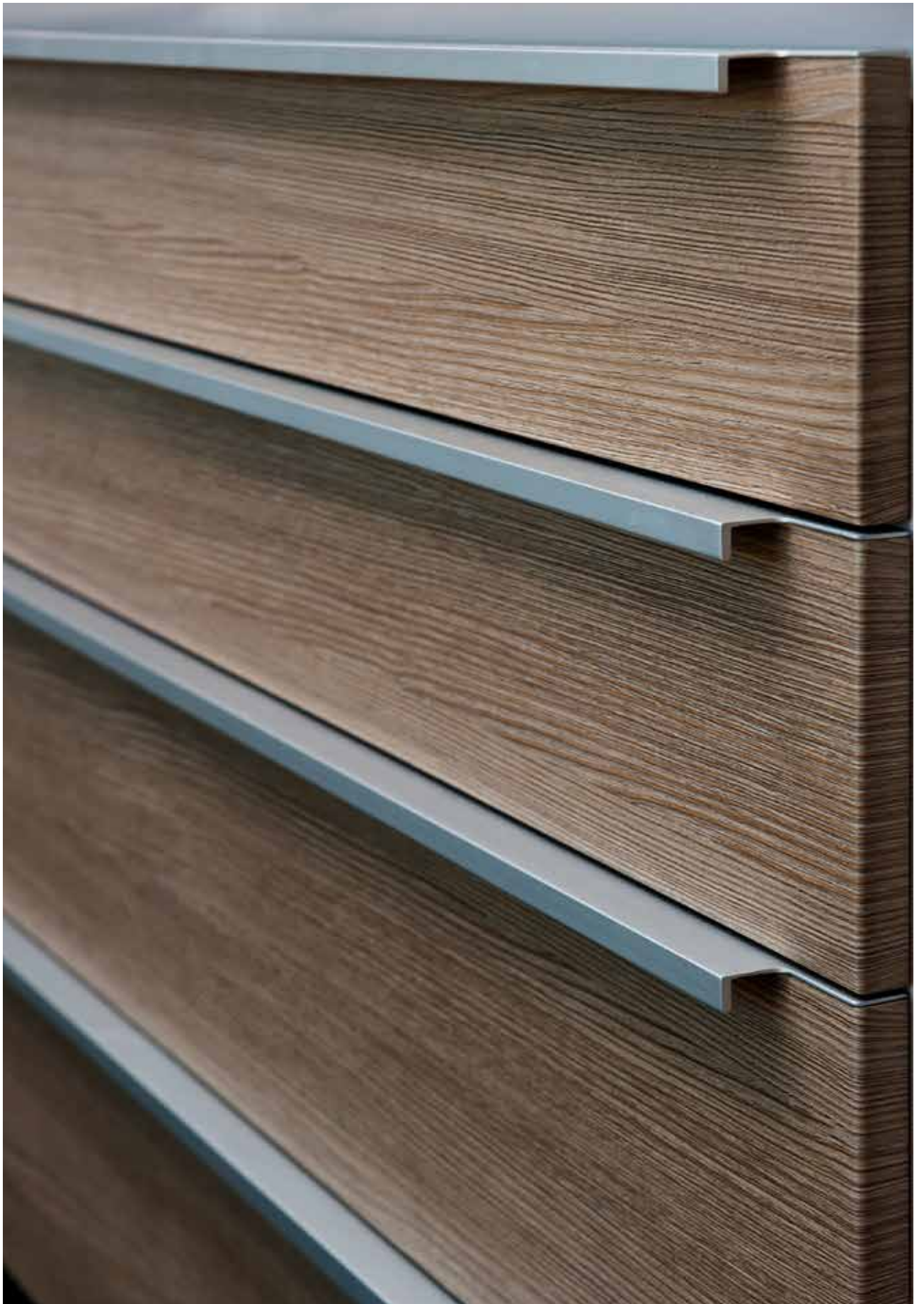

elite overlay & strip handles

Ultimate Top Handle

Code	Finish	Length	Height	Depth
6210	MC	298	12	41
6211	MC	398	12	41
6212	MC	448	12	41
6213	MC	498	12	41
6215	MC	598	12	41
6216	MC	698	12	41
6217	MC	798	12	41
6219	MC	898	12	41
6221	MC	998	12	41
6222	MC	1198	12	41

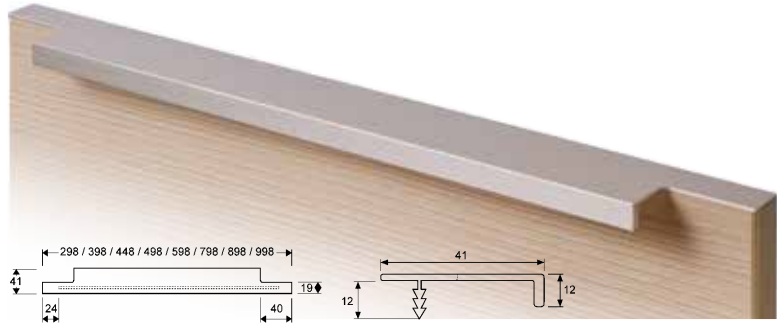

Madrid Pull

Code	Finish	Holes	Length	Height	Width
8873	AL	Every 96mm	250	17	9
8875	AL	Every 96mm	500	17	9
8876	AL	Every 96mm	1000	17	9



Nouveau Pull

Code	Finish	CC	Length	Height	Width
2301	BN	128	140	18	13
2302	MC	128	140	18	13



Savilla Pull

Code	Finish	CC	Length	Height	Width
8806	BN	128	160	18	12
8808	BN	192	224	18	12



Cordoba Pull

Code	Finish	CC	Length	Height	Width
8800	SB	16	33	20	15
8801	SB	160	177	20	15
8803	SB	256	273	20	15
8795	SN	16	33	20	15
8796	SN	160	177	20	15
8797	SN	256	273	20	15

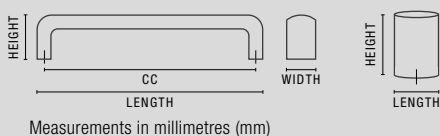

Overlay Pull

Code	Finish	CC	Length
2060	BN	64	105
2061	BN	128	168
2063	BN	192	233
2065	SB	128	168
2073	SB	192	233
2066	CP	64	105
2067	MC	64	105
2068	MC	128	168
2070	MC	192	1000



Kasia Pull

Code	Finish	CC	Length
4722	CN	64	104
4724	CN	128	168
4726	CN	192	232
4732	SB	64	104
4734	SB	128	168
4736	SB	192	232

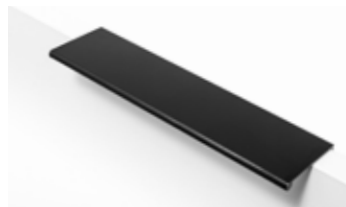
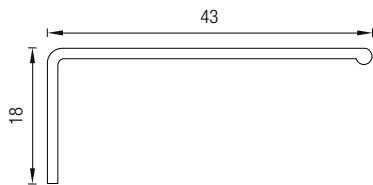

Lorette Overlay Pull

Code	Finish	CC	Length
4801	BN	51	
4802	SB	51	
4803	MC	51	

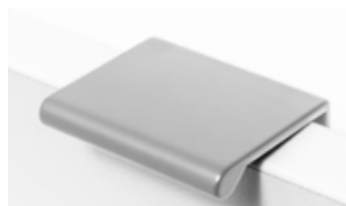
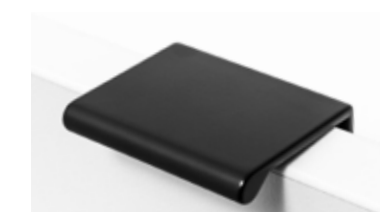
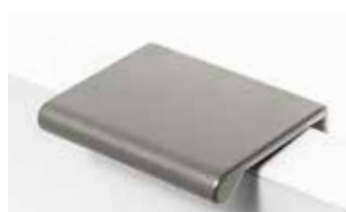

Aurora Pull

Code	Finish	Length	Height	Width
6410	BN	298	18	40.5
6411	BN	398	18	40.5
6412	BN	448	18	40.5
6413	BN	498	18	40.5
6415	BN	598	18	40.5
6416	BN	698	18	40.5
6417	BN	798	18	40.5
6419	BN	898	18	40.5
6420	BN	998	18	40.5
6510	SB	298	18	40.5
6511	SB	398	18	40.5
6512	SB	448	18	40.5
6513	SB	498	18	40.5
6515	SB	598	18	40.5
6516	SB	698	18	40.5
6517	SB	798	18	40.5
6519	SB	898	18	40.5
6520	SB	998	18	40.5

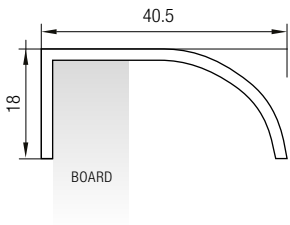

Electra Pull

Code	Finish	CC	Length	Height	Width
6760	SS	32	52	9.5	40
6762	SS	96	116	9.5	40
6764	SS	192	212	9.5	40
6766	SS	256	276	9.5	40
6768	SS	352	372	9.5	40
6769	SS	416	436	9.5	40

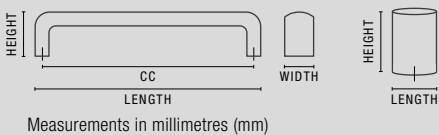
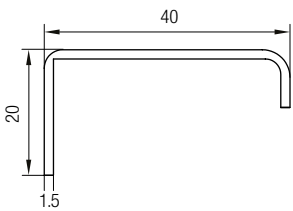

Lucia Pull

Code	Finish	CC	Length	Height	Width
6770	BNM	32	52	16	41
6771	BNM	50	70	16	41
6772	BNM	128	148	16	41
6774	BNM	256	276	16	41
6776	SB	32	52	16	41
6778	SB	50	70	16	41
6779	SB	128	148	16	41
6780	SB	256	276	16	41
6782	GM	32	52	16	41
6783	GM	50	70	16	41
6784	GM	128	148	16	41
6785	GM	256	276	16	41
6786	WH	32	52	16	41
6787	WH	50	70	16	41
6788	WH	128	148	16	41
6789	WH	256	276	16	41

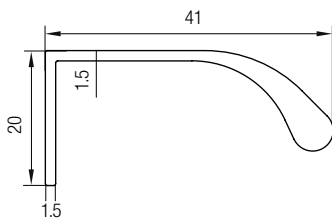
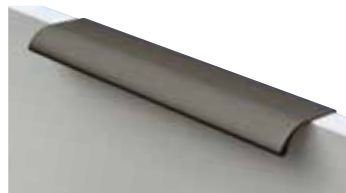
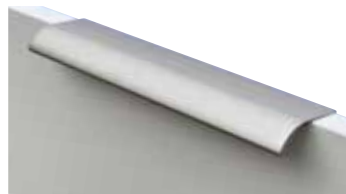





elite inset handles

Oriane Inset Handle

Code	Finish	CC	Length	Height	Depth
4815	BN	128	149		13.5
4816	SB	128	149		13.5



Romola Reverse Inset

Code	Finish	Length	Height	Depth
6223	MC	195	18	18
6224	CP	195	18	18



Ultimate Inset

Code	Finish	Length	Height	Depth
6225	BN	202	50	16
6226	GM	202	50	16

For use with painted doors

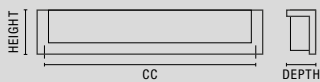
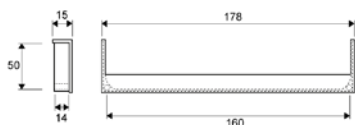

Measurements in millimetres (mm)

Elite Top Mount Pull

Code	Finish	CC	Length	Height	Depth
2042	MC	128	143	31	19
2043	MC	192	207	31	19



Stilvolle

Code	Finish	CC	Length	Height	Depth
2088	SC	160	203	39	13
2089	SC	224	284	39	13
2090	SC	320	374	39	13



Flush Pull

Code	Finish	CC	Length	Height	Depth
7178	MC	128	151	43	15
7179	MC	192	215	43	15
7180	MC	288	311	43	15

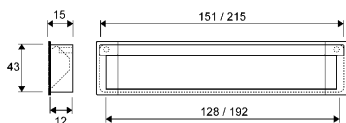

Rosette

Code	Finish	CC	Length	Height	Depth
7185	BN	160	170	55	16
7186	MC	160	170	55	16



Rectangle

Code	Finish	CC	Length	Height	Depth
7760	SC	128	134	39.5	10

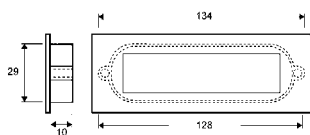

Elite Inset

Code	Finish	CC	Length	Depth
7765	BN	128	134	17
7767	BN	192	198	17
7769	BN	320	326	17
7761	SB	128	134	17
7762	SB	192	198	17

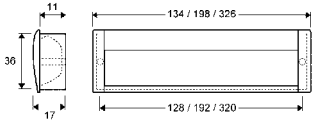

Contemporary Inset

Code	Finish	CC	Length	Depth
7774	SC	128	134	21
7776	SC	192	198	21
7778	SC	256	262	21
7779	SC	480	486	21
7782	SC	554	560	21

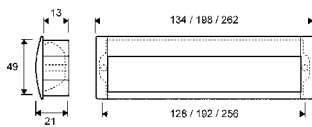

Elite Square Pull

Code	Finish	Length	Width	Depth
7780	SC	40	40	10
7783	BN	40	40	10

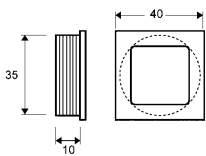

Elite Round Pull

Code	Finish	Length	Width	Depth
7781	BN	40	40	10

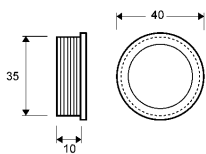



elite lumina lighting extrusions

Zeus LED 14.5mm Inset Extrusion

Code	Finish	Defuser	Length
8610	Silver	Milky White	3 metre
8619	Silver		End Cap

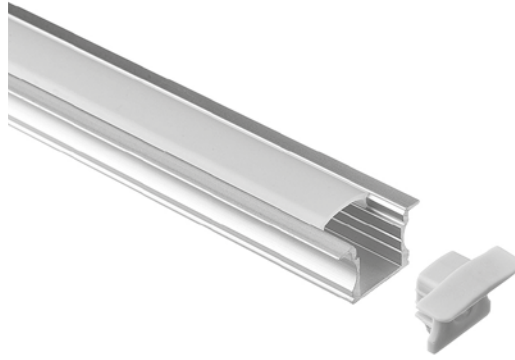
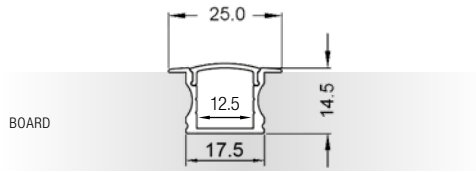

Zeus LED 7mm Inset Extrusion

Code	Finish	Defuser	Length
8611	Silver	Milky White	3 metre
8620	Silver		End Cap
8607	Black	Milky White	3 metre
8608	Black		End Cap

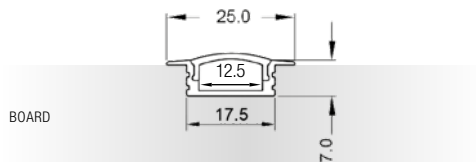

Hero LED 12mm Inset Extrusion

Code	Finish	Defuser	Length
8612	Silver	Milky White	3 metre
8621	Silver		End Cap

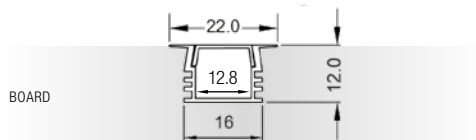

Hero LED 6mm Inset Extrusion

Code	Finish	Defuser	Length
8613	Silver	Milky White	3 metre
8622	Silver		End Cap

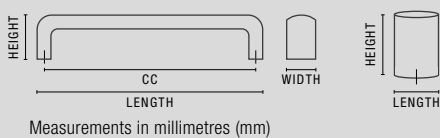
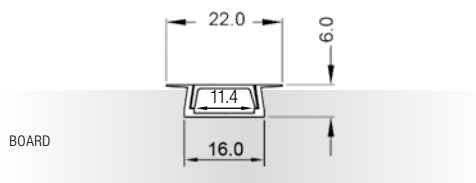

Leda
LED 7mm Surface Mount Extrusion

Code	Finish	Defuser	Length
8614	Silver	Milky White	3 metre
8623	Silver		End Cap

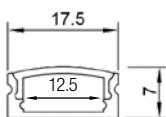

BOARD

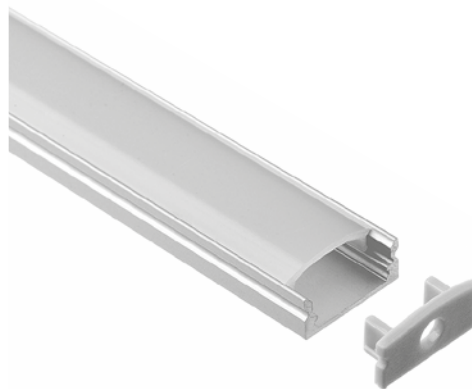

Lyra
LED 8.5mm Surface Extrusion

Code	Finish	Defuser	Length
8615	Silver	Milky White	3 metre
8624	Silver		End Cap



BOARD

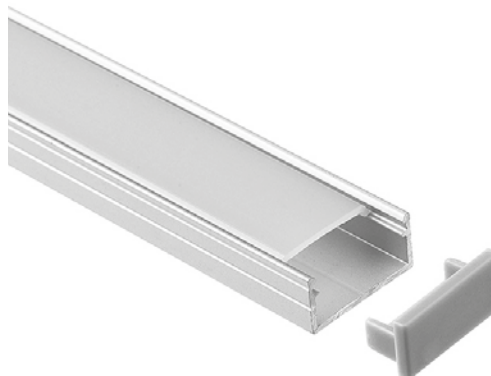

Eos
LED 9.5mm Surface Extrusion

Code	Finish	Defuser	Length
8616	Silver	Milky White	3 metre
8627	Silver		End Cap

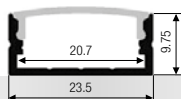

BOARD

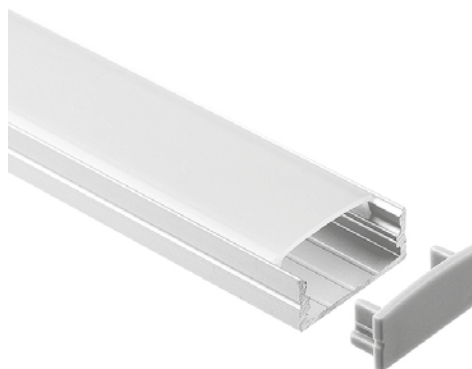

Elisa
LED 12mm Surface Extrusion

Code	Finish	Defuser	Length
8617	Silver	Milky White	3 metre
8625	Silver		End Cap

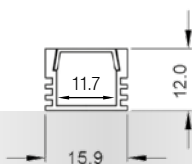

BOARD

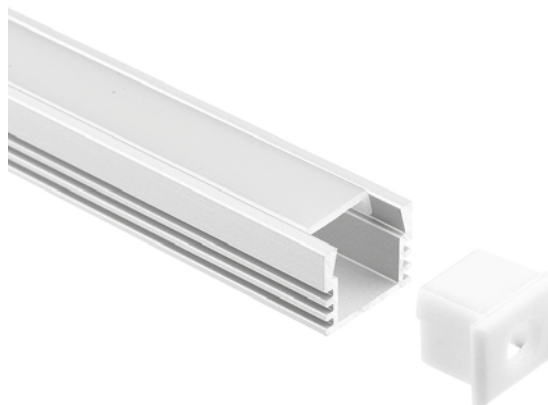

PLEASE CHECK MEASUREMENTS OF EXTRUSION BEFORE CUTTING AND INSTALLING. MEASUREMENTS CAN CHANGE WITHOUT NOTICE.

Neri LED 18.5mm Corner Extrusion

Code	Finish	Defuser	Length
8618	Silver	Milky White	3 metre
8626	Silver		End Cap

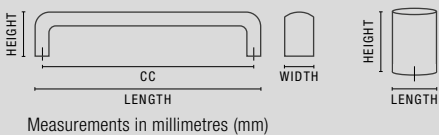
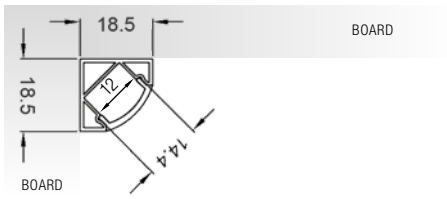



elite extrusion handles

Sachi Top Mount Handle

Code	Finish	Length	Height	Depth
8878	MC	3m	10	37

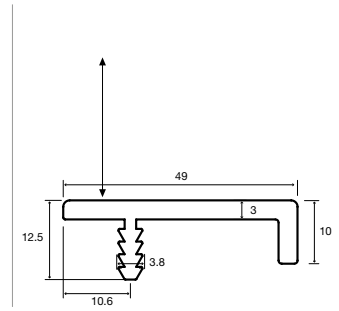

Benito Open Handle Top Section

Code	Finish	Length	Height	Depth
8877	MC	3m	10.8	19

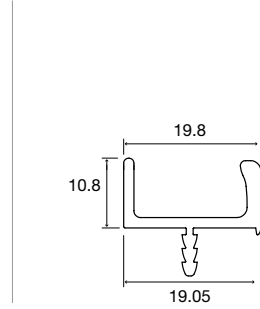

Benito Open Handle

Code	Finish	Length	Height	Depth
8879	MC	3m	30	19

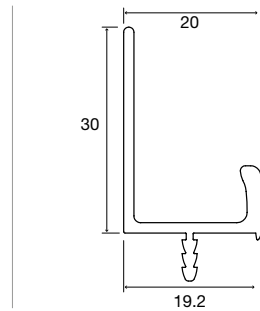

Rosa Top Mount Handle

Code	Finish	Length	Height	Depth
8891	MC	3m	14.7	37

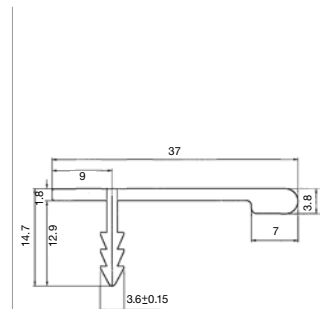
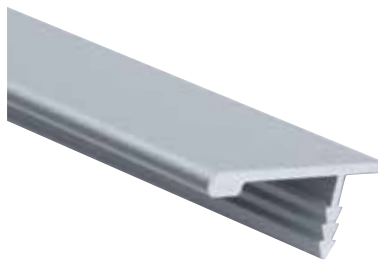

Sabra V Profile

Code	Finish	Length	Height	Board Width
8894	MC	3m	38	18

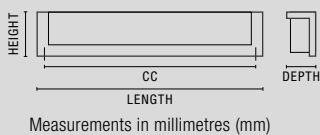
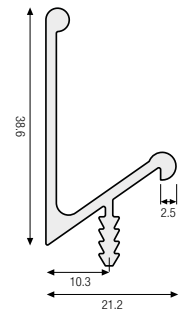

Cosima Clip On G Profile

Code	Finish	Length	Height	Width
8698	MC	3m	29.5	18
8699	MN	3m	29.5	18

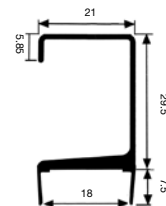

Allegra G Profile with End Caps

Code	Finish	Length	Height	Board Width
8701	MN	3m	35	18
8702	SB	3m	35	18
8703	AW	3m	35	18
8691	MN	End Caps Pair		
8692	SB	End Caps Pair		
8693	AW	End Caps Pair		

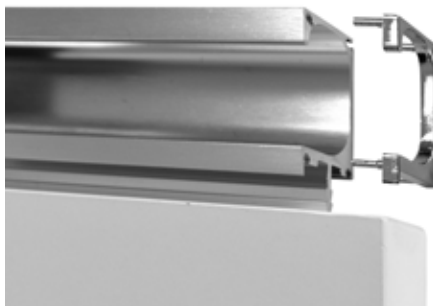

Novara G Central Profile

Code	Finish	Length	Height	Board Width
8890	MC	3m	35	18



Novara G Profile

Code	Finish	Length	Height	Board Width
8901	MN	3m	35	18

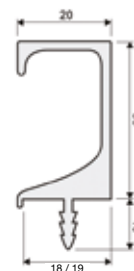
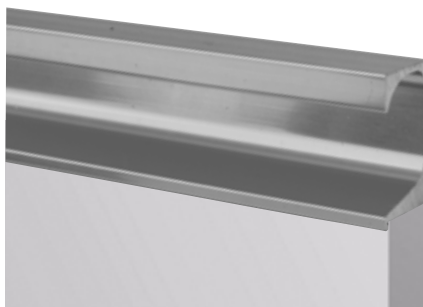

Novara G Profile

Code	Finish	Length	Height	Board Width
8896	MC	3m	35	16
8897	MC	3m	35	18
8899	SB	3m	35	18
8902	Raw	3m	35	18

No finish ready for powder coating

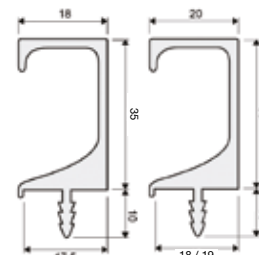

Apollo Centre Profile

Code	Finish	Length	Height	Board Width
8881	MC	3m	56	19
8882	SB	3m	56	19
8889	AW	3m	56	19

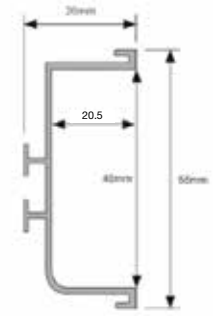

Apollo Top Profile

Code	Finish	Length	Height	Board Width
8883	MC	3m	44	19
8884	SB	3m	44	19
8887	AW	3m	44	19

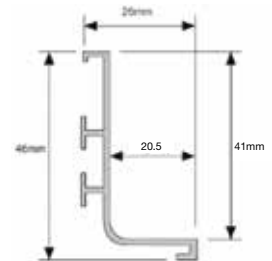

Apollo Bracket

Code	Finish	Length	Height	Width
8885	ZINC	35	35	13



Apollo Bracket Screw

Code	Finish	Height	Width
8886	ZINC	8	M-4

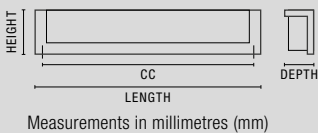
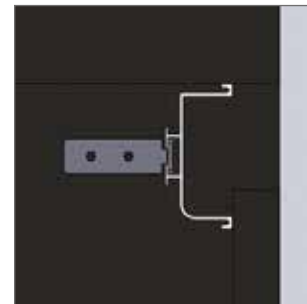
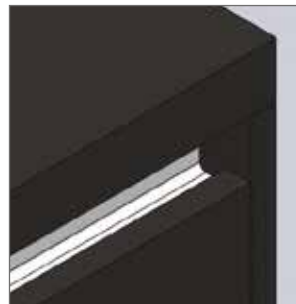
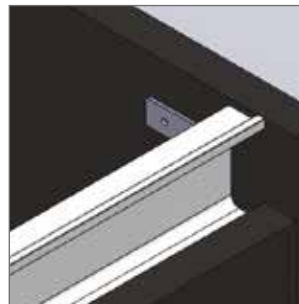
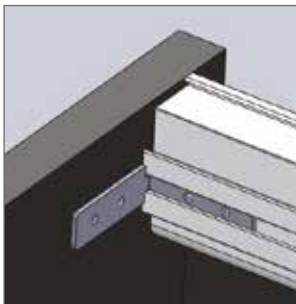



elite wardrobe fittings

Belt Hanger

Code	Length	Depth	Height	Can be cut down to:
8341	450	65	81	350mm



Tie Rack

Code	Length	Depth	Height	Can be cut down to:
8342	450	65	81	350mm



Sliding Clothes Holder

Code	Length	Finish
8344	350	Chrome



Oval Wardrobe Rail

Code	Length	Width	Height	Thickness	Finish
9100	3m	30mm	15mm	1.2mm	Chrome



Aluminium Oval Rail

Code	Length	Width	Height	Finish
9112	3m	15mm	30mm	MC



Round Tube

Code	Length	Width	Thickness	Finish
9400	3m	25mm	1.2mm	Polished Chrome Plated



Rail Bracket - Screw On

Code
9101

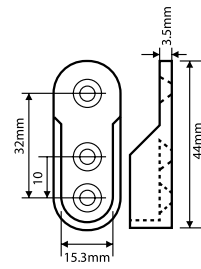

Rail Bracket - Dowel

Code
9102

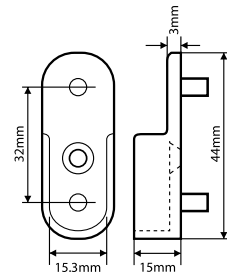

Slim Centre Bracket

Code
9103

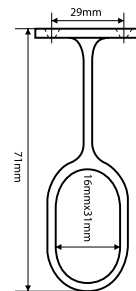

Rail Corner Bracket

Code
9106

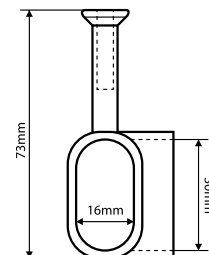

Concealed Bracket

Code	Width	Height	Finish	Fits
9109	19.5	31.2	Chrome	30 x 15mm Tube



Centre Bracket

Code	Height	Finish
9107	74.5	Chrome



End Bracket

Code	Height	Finish
9108	74.5	Chrome



Flange

Code	Finish	For use with:
9401	Chrome Plated	25mm Round Tube



Top Hanging Bracket

Code	Finish	Height	For use with:
9403	Chrome Plated	135	25mm Round Tube



Elbow Join

Code	Finish	Degrees	For use with:
9405	Chrome Plated	90 - 180	25mm Round Tube







italiana ferramenta

K Push Tech - Push to Open System

K PUSH TECH is the fully renewed and extended program of automatic opening systems for doors without handles or knobs. A special inner mechanism provides a very silent, yet powerful utilization, granting a long durability which makes it perfectly suitable for a wide range of doors.

K PUSH TECH is available with buffer, for cabinets using sprung hinges, and with magnet, for cabinets using unsprung hinges or negative hinges.

The aesthetic of buffers is now improved and the range of catch plates for version with magnet is even wider.

Lengths of the output paths: Medium – 20 mm, Long – 37 mm.

Ring thickness is 0,6 mm. Increased adjustment feature: +6 / -0.45 mm.

Beyond this negative adjustment the spring is deactivated. This feature allows to disable the ejector pin for safety reasons.

Perception of steps indicating the adjustment of the ejector pin: every step-stop position adjusts the door gap by 0.15 mm. A click-stop indicates the maximum adjustment range. These features prevent any undesired change of position of the ejector pin during its utilisation.

Highest magnet strength available in the market. New high performing materials to withstand unusual stresses and to avoid parts' damages. The new magnets are installed completely flush with the head of the ejector pin, in order to avoid any scratches on the door plates.

PAT. PENDING REGISTERED DESIGN

INSTALLATION TO BE EMBEDDED INSIDE THE PANEL

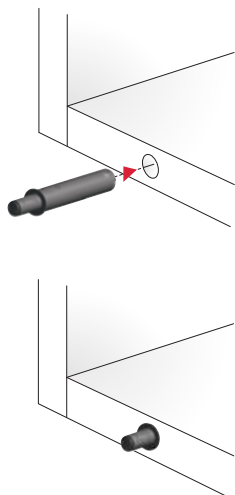

For details refer to K PUSH TECH and K LOCK DOOR PLATES.

WITH MAGNET for cabinets using unsprung hinges or negative hinges

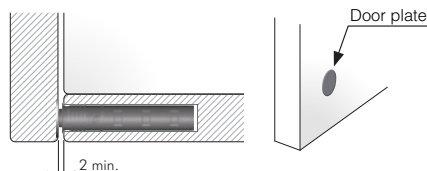

WITH BUFFER for cabinets using sprung hinges

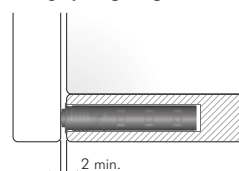

VERSIONS

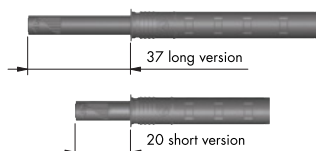

ADJUSTMENTS

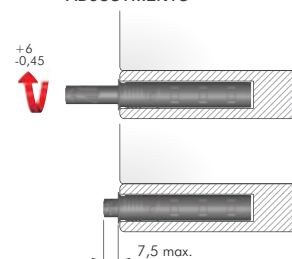

K Push Tech Installing Tool

Code	Material
57112000RO	Engineering Plastic

APPLICATION

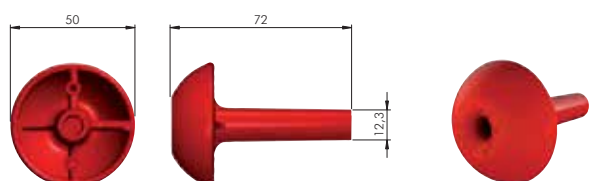
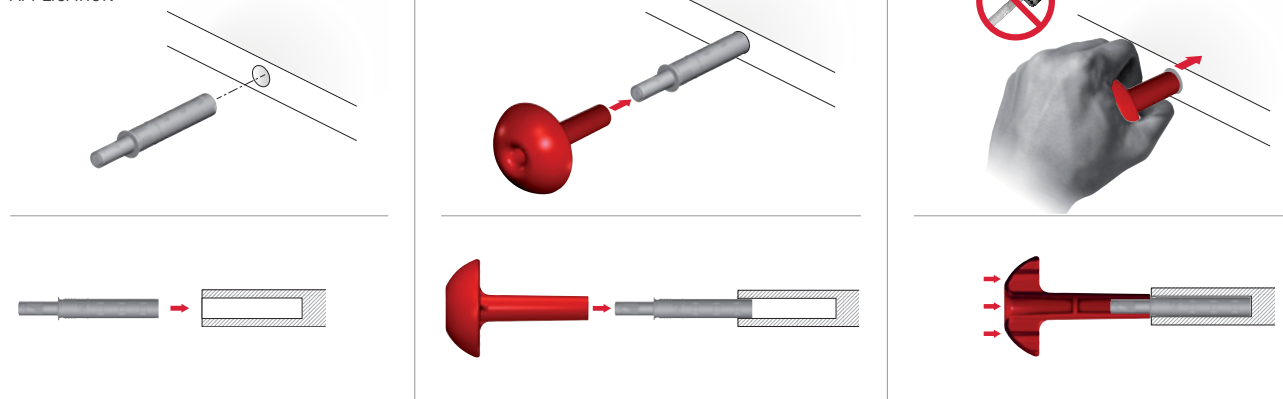

Push Catch Magnetic Short

Code	Colour	Material
57004023AB	White	Steel, Engineering Plastic

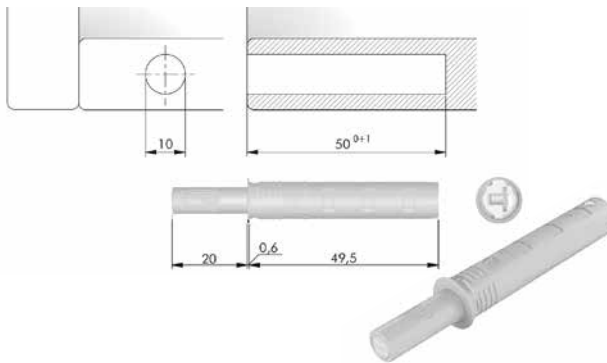

Push Catch Magnetic Long

Code	Colour	Material
57008020AB	White	Steel, Engineering Plastic

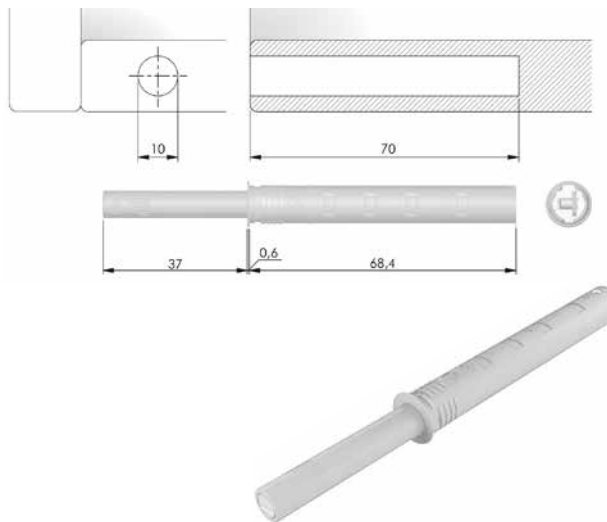

Adapter Shell Housing for Long Version

Code	Colour	Material
57025020AB	White	Engineering Plastic



Push Catch Buffer Short

Code	Colour	Material
57004043AB	White	Steel, Engineering Plastic, Soft Rubber

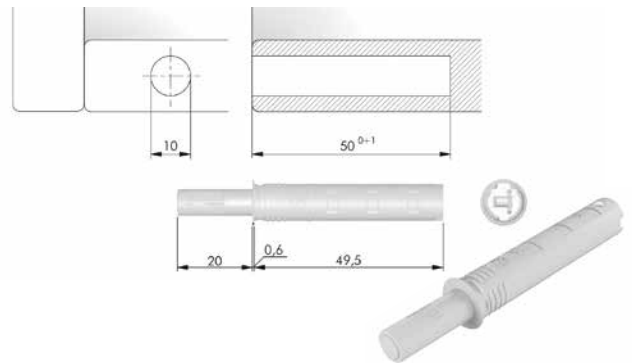

Push Catch Buffer Long

Code	Colour	Material
57008043AB	White	Steel, Engineering Plastic, Soft Rubber
57008040EE	Anthracite	Steel, Engineering Plastic, Soft Rubber

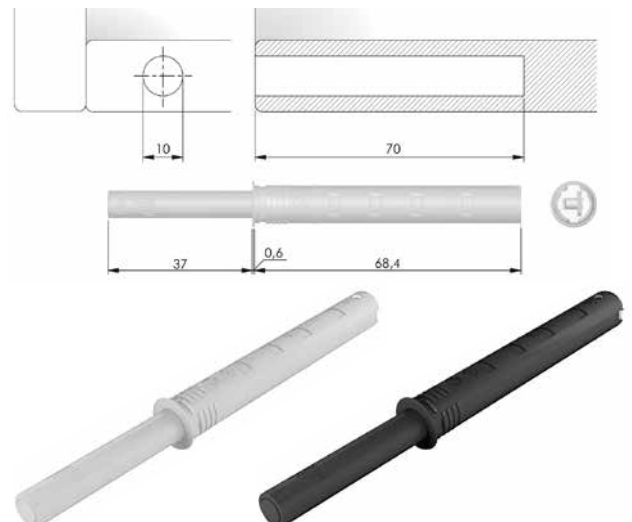

Adapter Mounting Plate for Long Version

Code	Colour	Material
57025040AB	White	Engineering Plastic

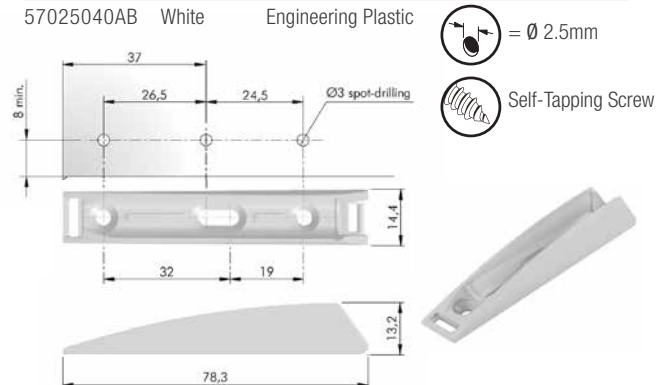

K Push Tech and K Lock Door Plates

Code	Material	System
55006020XD	Steel	Self Adhesive

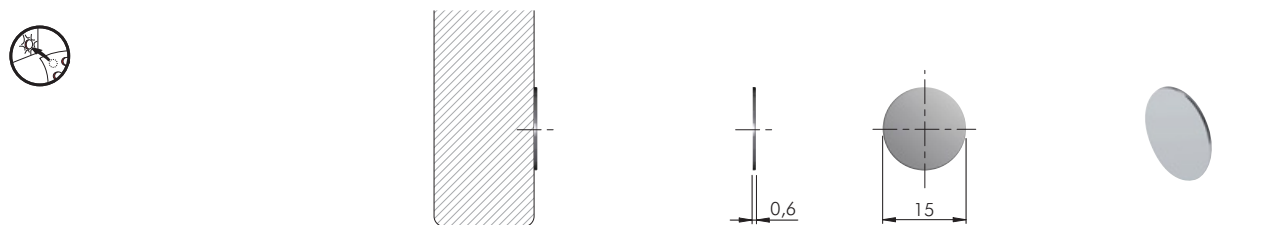

Code	Material	System
55006030YA	Steel	3mm Pin

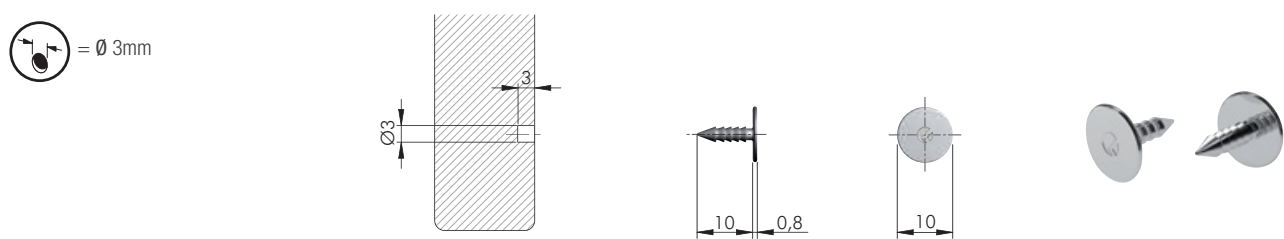

Code	Material	System
55006100YA	Steel	3mm Screw On

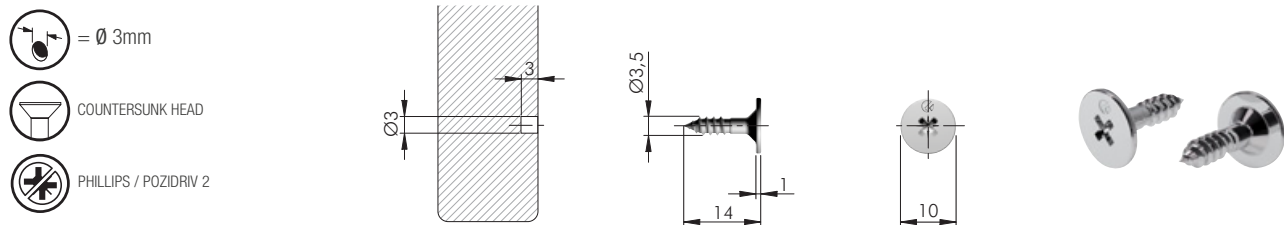

Code	Material	System
55006040YA	Steel	5mm Knock In

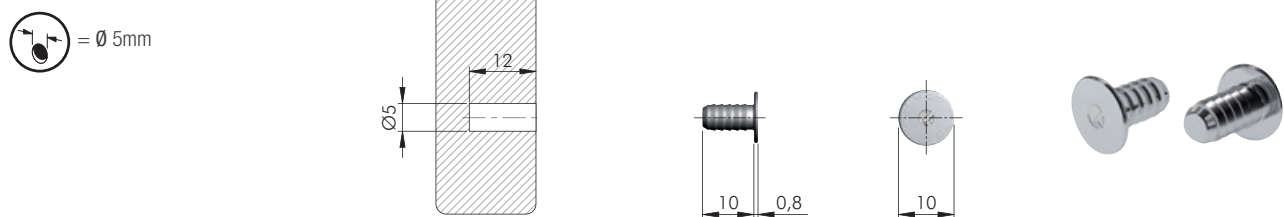

Fixing Accessory for K Push Tech Adapter Plates

Code	Material	System
60101390ZN	Steel	3mm Screw On

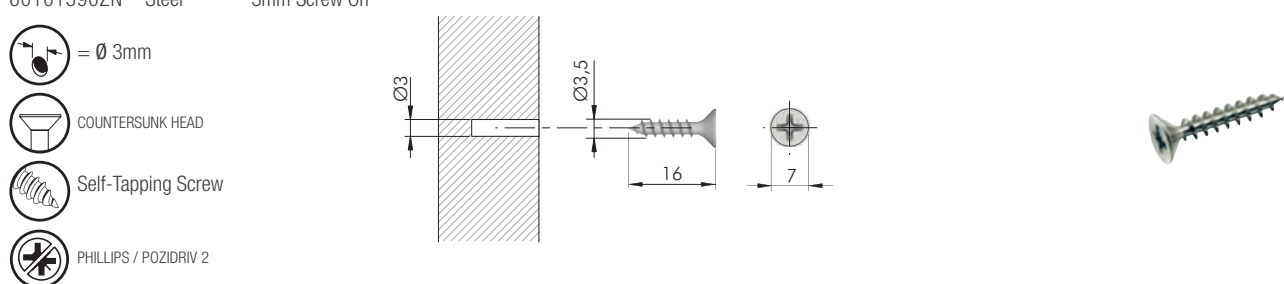



legs & towel rails

Square Leg

Code	Height	Finish	Leg Width
1234	100	Chrome	30
1236	150	Chrome	30



Adjustable Guide M10

Code	Height	Finish	Leg Width	Thread
1239	113	Brushed Nickel	45	M10

Suitable for leg 1246 and 1247



Round Leg - Adjustable

Code	Height	Finish	Leg Width
1246	100	Brushed Nickel	30
1247	150	Brushed Nickel	30



Square Leg Aluminium

Code	Height	Finish	Leg Width
1240	80	Aluminium	40
1244	100	Aluminium	40
1250	150	Aluminium	40
1255	200	Aluminium	40

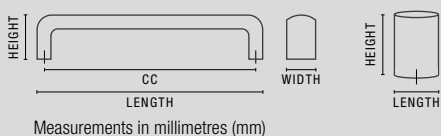

Table Leg

Code	Size	Diameter	Finish
7235	710	60	Brushed Nickel
7236	870	60	Brushed Nickel



Towel Rail

Code	Length	CC	Finish
1123	264	227	Chrome
1135	340	303	Chrome
1140	441	404	Chrome





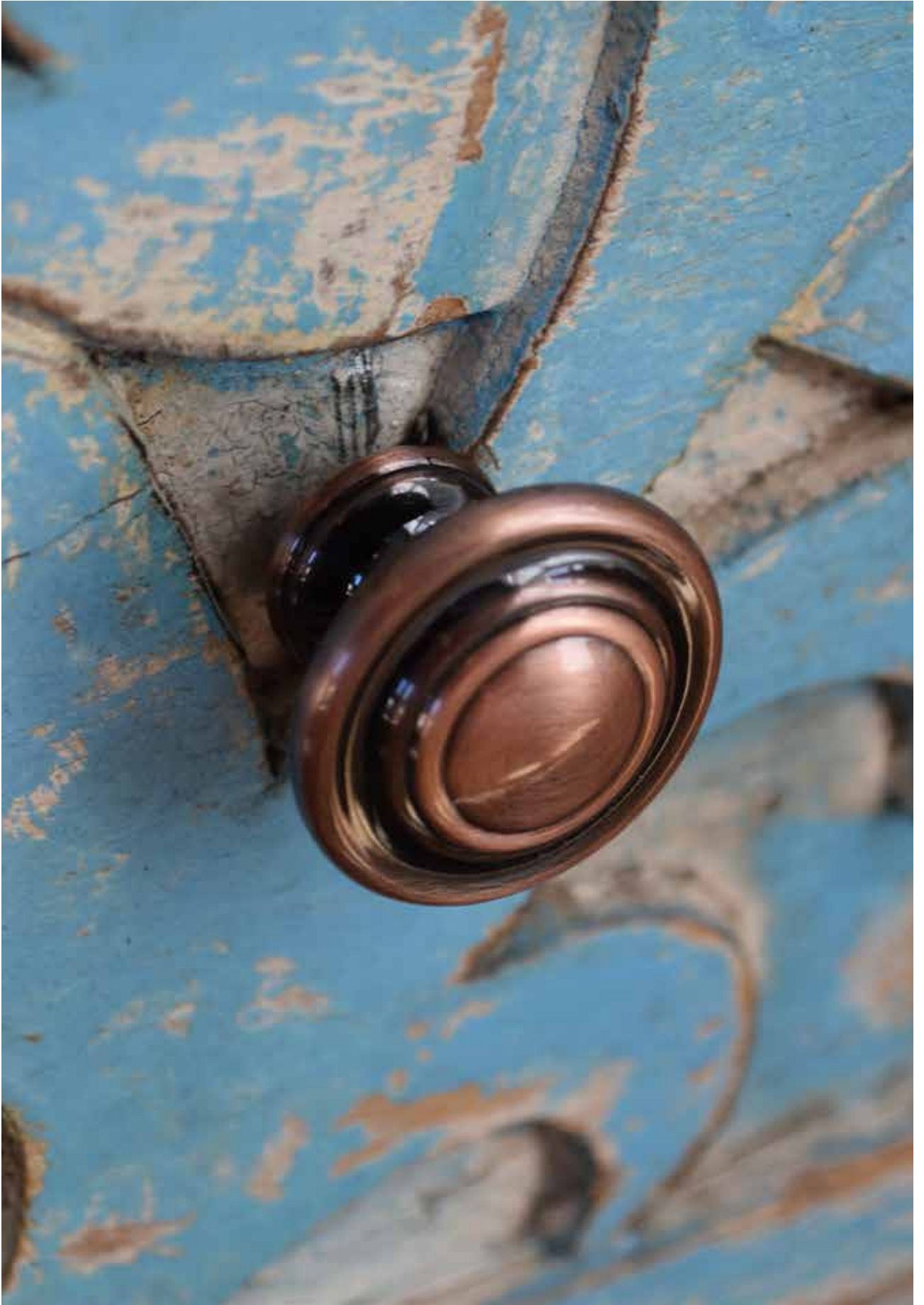

Code	Page	Code	Page	Code	Page	Code	Page	Code	Page	Code	Page	Code	Page
1123	77	2224	41	3901	31	6160	6, 18	6712	20	7030	22	8344	66
1135	77	2226	36, 41	3902	31	6171	18	6715	37	7031	22	8607	58
1140	77	2227	36, 41	3991	15	6172	18	6716	8, 37	7050	32	8608	58
1234	76	2229	14, 41	3993	15	6173	18	6717	37	7052	26, 32	8610	58
1236	76	2238	4, 43	3994	15	6174	18	6718	20	7057	32	8611	58
1239	76	2240	4, 43	3995	15	6194	18	6719	6, 20	7081	32	8612	58
1240	76	2301	48	3996	15	6195	18	6720	20	7082	32	8613	58
1244	76	2302	48	3997	15	6196	18	6721	20	7110	22	8614	59
1246	76	2420	35	3998	15	6197	19	6722	6, 20	7111	22	8615	59
1247	76	2421	35	3999	15	6199	19	6723	20	7112	7, 22	8616	59
1250	76	2422	35			6205	28, 37	6724	20	7178	55	8617	59
1255	76	2906	14	4000	8, 15, 37	6206	37	6725	20	7179	55	8618	60
1268	30	2908	4, 14	4001	5, 15	6207	37	6726	20	7180	55	8619	58
1269	30	2912	14	4002	5, 15	6208	37	6727	20	7185	55	8620	58
1270	30	2915	14	4003	5, 15	6210	48	6758	21	7186	55	8621	58
1275	30	2917	14, 26	4004	8, 15, 37	6211	48	6759	7, 21	7201	23	8622	58
1277	30	2918	4, 14	4005	5, 15	6212	48	6760	50	7202	23	8623	59
1278	30			4006	5, 15	6213	48	6762	50	7203	23	8624	59
1290	30	3003	30	4007	5, 15	6215	48	6764	50	7204	23	8625	59
1559	44	3004	30	4008	15, 37	6216	48	6766	50	7205	23	8626	60
1840	34	3005	30	4009	15	6217	48	6768	50	7207	23	8627	59
1846	34	3007	30	4010	15	6219	48	6769	50	7208	23	8691	63
1847	34	3020	30	4011	15	6221	48	6770	51	7209	23	8692	12, 63
1852	34	3026	15	4012	15, 37	6222	48	6771	51	7235	77	8693	63
1853	34	3027	30	4013	15	6223	54	6772	51	7236	77	8698	63
1854	27, 34	3028	30	4014	15	6224	28, 54	6774	51	7280	23	8699	63
1855	40	3029	30	4015	15	6225	54	6776	10, 51	7281	23	8701	63
1856	40	3030	15	4030	5, 15	6226	11, 54	6778	10, 51	7283	23	8702	12, 63
1857	40	3031	15	4034	5, 15	6228	19	6779	10, 51	7285	23	8703	63
1860	40	3032	15	4036	5, 15	6229	6, 19	6780	10, 51	7287	23	8795	37, 48
1861	40	3033	15	4252	16	6231	19	6782	10, 51	7301	23	8796	48
1865	44	3034	15	4253	16	6232	19	6783	10, 51	7303	23	8797	48
1998	34	3035	30	4255	16	6233	19	6784	10, 51	7305	23	8800	11, 37, 48
1999	34	3036	30	4331	16	6239	6, 19	6785	10, 51	7306	23	8801	11, 48
		3037	30	4332	16	6240	6, 19	6786	51	7310	23	8803	11, 48
		3038	30	4333	16	6410	50	6787	51	7311	23	8806	48
2002	34	3050	31	4334	16	6411	50	6788	51	7312	23	8808	48
2004	34	3055	31	4335	16	6412	50	6789	51	7313	23	8873	48
2020	35	3057	31	4336	16	6413	50	6885	21	7314	23	8875	48
2025	35	3059	31	4337	16, 26	6415	50	6886	21	7315	23	8876	48
2027	35	3060	31	4338	16, 26	6416	50	6888	21	7440	24	8877	62
2028	27, 35	3072	31	4339	16	6417	50	6889	21	7441	24	8878	62
2033	35	3075	31	4340	16	6419	50	6906	21	7443	24	8879	62
2034	35	3076	31	4701	16	6420	50	6907	21	7444	24	8881	64
2039	42	3077	5, 31	4702	16	6432	19	6908	21	7446	24	8882	12, 64
2042	55	3082	31	4703	16	6434	19	6909	21	7448	24	8883	64
2043	55	3084	31	4704	5, 16	6435	19	6910	21	7450	24	8884	12, 64
2046	40	3793	28, 36, 41	4722	49	6436	19	6911	21	7451	24	8885	64
2048	42	3797	36, 41	4724	49	6438	19	6912	21	7452	24	8886	64
2050	9, 42	3798	8, 36, 41	4726	49	6440	19	6920	21	7453	24	8887	64
2051	42	3801	36, 41	4732	10, 49	6442	19	6921	21	7454	24	8889	64
2052	28, 42	3802	36, 41	4734	10, 49	6510	11, 50	6922	21	7455	24	8890	63
2054	28, 42	3803	36, 41	4736	10, 49	6511	11, 50	6923	21	7457	24	8891	62
2055	40	3804	36, 41	4801	49	6512	11, 50	6924	21	7460	24	8894	62
2056	40	3805	46	4802	10, 49	6513	11, 50	6926	21	7461	24	8896	63
2057	40	3806	46	4803	49	6515	11, 50	6928	21	7463	24	8897	63
2058	9, 42	3807	46	4810	17	6516	11, 50	6930	21	7465	24	8899	12, 63
2059	42	3808	46	4811	6, 17	6517	11, 50	6941	7, 21	7470	24, 27	8901	63
2060	49	3809	5, 46	4812	17	6519	11, 50	6942	7, 21	7472	24, 27	8902	63
2061	49	3810	5, 46	4815	54	6520	11, 50	6943	7, 21	7474	24, 27		
2063	49	3811	5, 46	4816	11, 54	6548	19	6945	7, 21	7481	24	9100	67
2065	10, 49	3812	5, 46			6549	19	6991	21	7483	24	9101	68
2066	49	3814	46	5710	6, 17	6550	19	6992	21	7484	24	9102	68
2067	49	3815	8, 46	5711	6, 17	6551	19	6993	21	7486	24	9103	68
2068	49	3820B	9, 42	5712	6, 17	6552	19			7488	24	9106	68
2070	49	3820D	42	5713	6, 17	6553	19	7001	21	7490	24	9107	69
2071	35	3820P	42	5805	17	6554	19	7002	21	7560	24	9108	69
2072	35	3820P	42	5806	17	6555	19	7003	21	7562	24	9109	68
2073	10, 49	3821B	9, 42	5807	17	6556	19	7004	21	7563	24	9112	67
2075	35	3821D	42	5808	17	6557	19	7005	21	7565	24	9400	67
2076	35	3821P	42	5810	17	6559	19	7006	21	7567	24	9401	69
2088	55	3822D	42	5811	17	6571	20	7007	21	7760	55	9403	69
2089	55	3825	42	5812	17	6572	20	7008	21	7761	11, 56	9405	69
2090	55	3826	42	5813	17	6573	20	7011	7, 22, 46	7762	11, 56		
2100	36, 40	3827	42	5814	17	6574	20	7012	7, 22, 46	7765	56		
2101	27, 36, 40	3829	45	5815	6, 17	6663	20	7013	22, 46	7767	56	57025040AB	73
2102	36, 40	3830	44	5816	6, 17	6664	20	7014	22, 46	7769	56	57025020AB	73
2103	36, 40	3831	45	5817	6, 17	6701	20	7016	22, 46	7774	56	57004023AB	73
2104	36, 40	3832	45	5818	6, 17	6702	20	7017	22, 46	7776	56	57004043AB	73
2117	36	3833	45			6703	20	7018	26	7778	56	55006020XD	74
2119	36	3834	44	6010	18	6704	20	7021	22	7779	56	55006030YA	74
2214	36, 46	3835	45	6020	18	6705	6, 20	7022	22	7780	56	55006040YA	74
2215	36, 46	3836	45	6030	18	6706	6, 20	7023	22	7781	56	55006100YA	74
2216	36, 46	3837	44	6040	18	6707	6, 20	7024	22	7782	56	57008020AB	73
2217	7, 36	3841	9, 43	6050	18	6708	6, 20	7025	22	7783	56	57008040EE	73
2218	27, 36	3842	9, 43	6060	18	6709	20	7026	22			57008043AB	73
2219	36	3850	44	6157	18	6710	20	7027	22	8341	66	57112000RO	72
2221	4, 41	3899	26, 31	6158	18	6711	20	7028	22	8342	66	60101390ZN	74
2223	8, 36, 41	3900	31										

elite
HARDWARE

ELITEHARDWARE.CO.NZ SALES@ELITEHARDWARE.CO.NZ