

## Handles



Code	Size CC	Overall Size	Projection	Width	Finish	Material
<b>1004</b>	96 mm	100 mm	19 mm	10 mm	BN,SC	zinc alloy
	128 mm	132 mm	25 mm	11 mm		



Code	Size CC	Overall Size	Projection	Width	Finish	Material
<b>1005</b>	96 mm	105 mm	30 mm	14 mm	BN	zinc alloy
	128 mm	148 mm	30 mm	14 mm		



Code	Size CC	Overall Size	Projection	Width	Finish	Material
<b>1012</b>	96 mm	114 mm	20 mm	10 mm	BN,SN,SC	zinc alloy
	128 mm	148 mm	25 mm	10 mm		
	192 mm	227 mm	32 mm	10 mm	BN	steel
	320 mm	355 mm	32 mm	10 mm		



Code	Size CC	Overall Size	Projection	Width	Finish	Material
<b>1090</b>	96 mm	114 mm	29 mm	8 mm	SC, PC	zinc alloy







Code	Size CC	Overall Size	Projection	Width	Finish	Material
<b>1092</b>	64 mm	72 mm	26 mm	12 mm	BN,SC	zinc alloy
	96 mm	112 mm	26 mm	12 mm		
	128 mm	131 mm	31 mm	14 mm		
	160 mm	167 mm	31 mm	14 mm		
	256 mm	262 mm	31 mm	14 mm		







Code	Size CC	Overall Size	Projection	Width	Finish	Material
<b>1211</b>	96 mm	113	27 mm	10 mm	BN, SC	aluminium
	128 mm	142	27 mm	12 mm		zinc alloy

## Barhandles







						
Code	Size CC	Overall Size	Projection	Diameter	Finish	Material
<b>2001115</b>	64 mm	115 mm	35 mm	12 mm	SS	SS =
<b>2001155</b>	96 mm	155 mm	35 mm	12 mm		Stainless
<b>2001200</b>	128 mm	200 mm	35 mm	12 mm		Steel
<b>2001250</b>	160 mm	250 mm	35 mm	12 mm		
<b>2001300</b>	192 mm	300 mm	35 mm	12 mm		
<b>2001350</b>	224 mm	350 mm	35 mm	12 mm		
<b>2001400</b>	288 mm	400 mm	35 mm	12 mm		
<b>2001450</b>	320 mm	450 mm	35 mm	12 mm		
<b>2001500</b>	360 mm	500 mm	35 mm	12 mm		
<b>2001600</b>	480 mm	600 mm	35 mm	12 mm		







						
Code	Size CC	Overall Size	Projection	Diameter	Finish	Material
<b>2002</b>	96 mm	102 mm	32 mm	10 mm	SS, SC	SS =
	128 mm	138 mm	32 mm	10 mm	and BN	Stainless
	160 mm	168 mm	32 mm	10 mm		Steel
	192 mm	200 mm	32 mm	10 mm		SC/BN
	288 mm	296 mm	32 mm	10 mm		= Steel



						
Code	Size CC	Overall Size	Projection	Width	Finish	Material
<b>2004108</b>	96 mm	108 mm	30 mm	12x12 mm	SS	SS =
<b>2004140</b>	128 mm	140 mm	30 mm	12x12 mm		Stainless
<b>2004172</b>	160 mm	172 mm	30 mm	12x12 mm		Steel
<b>2004204</b>	192 mm	204 mm	30 mm	12x12 mm		
<b>2004236</b>	224 mm	236 mm	30 mm	12x12 mm		
<b>2004268</b>	256 mm	268 mm	30 mm	12x12 mm		
<b>2004300</b>	288 mm	300 mm	30 mm	12x12 mm		
<b>2004332</b>	320 mm	332 mm	30 mm	12x12 mm		
<b>2004364</b>	352 mm	364 mm	30 mm	12x12 mm		
<b>2004396</b>	384 mm	396 mm	30 mm	12x12 mm		
<b>2004428</b>	416 mm	428 mm	30 mm	12x12 mm		
<b>2004492</b>	480 mm	492 mm	30 mm	12x12 mm		
<b>2004524</b>	512 mm	524 mm	30 mm	12x12 mm		
<b>2004620</b>	608 mm	620 mm	30 mm	12x12 mm		



						
Code	Size CC	Overall Size	Projection	Width	Finish	Material
<b>2005</b>	192 mm	208	32 mm	14 mm	SS	Stainless
	448 mm	464	32 mm	14 mm	SS	Steel hollow



Code	Size CC	Overall Size	Projection	Width	Finish	Material
<b>2006140</b>	128 mm	140 mm	30 mm	12x12 mm		Stainless
<b>2006172</b>	160 mm	172 mm	30 mm	12x12 mm		Steel
<b>2006204</b>	192 mm	204 mm	30 mm	12x12 mm		hollow
<b>2004268</b>	256 mm	268 mm	30 mm	12x12 mm		
<b>2004332</b>	320 mm	332 mm	30 mm	12x12 mm		



Code	Size CC	Overall Size	Projection	Width	Finish	Material
<b>3060</b>	160 mm	197mm	29 mm	11 mm	BN,SC	zinc alloy



Code	Size CC	Overall Size	Projection	Width	Finish	Material
<b>3061</b>	128 mm	158 mm	25 mm	20 mm	BN,SC	zinc alloy
	160 mm	190 mm	26 mm	22 mm	BL	
	192 mm	226 mm	27 mm	24 mm		



Code	Size CC	Overall Size	Projection	Width	Finish	Material
<b>3064</b>	64 mm	85 mm	25 mm	8 mm	BN, SC	zinc alloy
	96 mm	119 mm	26 mm	8 mm		
	128 mm	155 mm	26 mm	8 mm		
	160 mm	192 mm	27 mm	8 mm		
	192 mm	224 mm	27 mm	8 mm		
	240 mm	272 mm	27 mm	8 mm		
	256 mm	290 mm	28.5 mm	8 mm		
	320 mm	357 mm	28.5 mm	8.5 mm		



Code	Size CC	Overall Size	Projection	Width	Finish	Material
<b>3090</b>	128 mm	166 mm	30 mm	19 mm	BN,SC	zinc alloy



Code	Size CC	Overall Size	Projection	Width	Finish	Material
<b>3126</b>	128 mm	179 mm	33 mm	14 mm	BN, SC	zinc alloy
	288 mm	339 mm	33 mm	14 mm		



Code	Size CC	Overall Size	Projection	Width	Finish	Material
<b>3129</b>	128 mm	137 mm	33 mm	15 mm	BN, SC	zinc alloy
	288 mm	297 mm	33 mm	15 mm		



Code	Size CC	Overall Size	Projection	Width	Finish	Material
<b>3802</b>	160 mm	175 mm	33 mm	13 mm	PE, AB, BL	zinc alloy
	256 mm	271 mm	33 mm	13 mm		zinc alloy



Code	Size CC	Overall Size	Projection	Width	Finish	Material
<b>4019</b>	128 mm	140 mm	32 mm	10 mm	BN,SC	zinc alloy
	160 mm	172 mm	32 mm	10 mm		
	192 mm	204 mm	32 mm	10 mm		
	224 mm	236 mm	32 mm	10 mm		
	256 mm	268 mm	32 mm	10 mm		

**Siena**



Code	Size CC	Overall Size	Projection	Width	Finish	Material
<b>4020</b>	32 mm	40 mm	25 mm	19 mm	SC	aluminium
	96 mm	108 mm	25 mm	19 mm		
	128 mm	140 mm	25 mm	19 mm		
	160 mm	172 mm	25 mm	19 mm		
	192 mm	204 mm	25 mm	19 mm		
	224 mm	236 mm	25 mm	19 mm		
	288 mm	300 mm	25 mm	19 mm		
	384 mm	396 mm	25 mm	19 mm		
	480 mm	492 mm	25 mm	19 mm		
	608 mm	620 mm	25 mm	19 mm		



### Estrada



Code	Size CC	Overall Size	Projection	Width	Finish	Material
<b>4021</b>	60 mm	60 mm	40mm	8 mm	SC, BL	aluminium
	120 mm	120 mm	40mm	8 mm		
	240 mm	240 mm	40mm	8 mm		
	400 mm	400 mm	40mm	8 mm		



### Estiva



Code	Size CC	Overall Size	Projection	Width	Finish	Material
<b>4022</b>	300 mm	300 mm	35 mm	15 mm	SC,BL,WH	aluminium
	400 mm	400 mm	35 mm	15 mm		
	500 mm	500 mm	35 mm	15 mm		
	600 mm	600 mm	35 mm	15 mm		



### Avesta



Code	Size CC	Overall Size	Projection	Width	Finish	Material
<b>4023</b>	256 mm	276 mm	24 mm	19 mm	BN, PC	aluminium
	288 mm	308 mm	24 mm	19 mm		
	320 mm	340 mm	24 mm	19 mm		

**Limited stocks available, see price list**



### Aseda



Code	Size CC	Overall Size	Projection	Width	Finish	Material
<b>4024</b>	96 mm	106 mm	35 mm	16 mm	SC and BN	aluminium
	128 mm	138 mm	35 mm	16 mm		
	160 mm	170 mm	35 mm	16 mm		
	192 mm	202 mm	35 mm	16 mm		
	224 mm	234 mm	35 mm	16 mm		
	256 mm	266 mm	35 mm	16 mm		
	288 mm	292 mm	35 mm	16 mm		
	352 mm	362 mm	35 mm	16 mm		
	416 mm	426 mm	35 mm	16 mm		
	512 mm	522 mm	35 mm	16 mm		
	608 mm	618 mm	35 mm	16 mm		
	736 mm	746 mm	35 mm	16 mm		
960 mm	970 mm	35 mm	16 mm			



**Barcelona**



Code	Size CC	Overall Size	Projection	Width	Finish	Material
<b>4026</b>	96 mm	113 mm	29 mm	15 mm	SC, BN, PC	aluminium
	128 mm	145 mm	29 mm	15 mm	BL WH	
	160 mm	177 mm	29 mm	15 mm		
	192 mm	209 mm	29 mm	15 mm		
	320 mm	337 mm	29 mm	15 mm		



**Valencia**



Code	Size CC	Overall Size	Projection	Width	Finish	Material
<b>4028</b>	128 mm	145 mm	29 mm	25 mm	SC, PC	aluminium
	160 mm	177 mm	29 mm	25 mm	BL WH	
	192 mm	209 mm	29 mm	25 mm		
	320 mm	337 mm	29 mm	25 mm		
	416 mm	433 mm	29 mm	25 mm		



**Merano**



Code	Size CC	Overall Size	Projection	Width	Finish	Material
<b>4029</b>	128 mm	152 mm	35 mm	13 mm	SC and BN	aluminium
	160 mm	184 mm	35 mm	13 mm		
	192 mm	216 mm	35 mm	13 mm		
	224 mm	248 mm	35 mm	13 mm		
	288 mm	312 mm	35 mm	13 mm		
	352 mm	376 mm	35 mm	13 mm		



**Arezzo**



Code	Size CC	Overall Size	Projection	Width	Finish	Material
<b>4030</b>	128 mm	136 mm	28 mm	8.5 mm	SC, BN, BL WH	zinc alloy
	160 mm	168 mm	28 mm	8.5 mm		
	192 mm	200 mm	28 mm	8.5 mm		
	320 mm	328 mm	28 mm	8.5 mm		



### Cortona



Code	Size CC	Overall Size	Projection	Width	Finish	Material
4031	160 mm	174 mm	37 mm	9.5 mm	SC, BN, BR	zinc alloy
	320 mm	333 mm	37 mm	9.5 mm		



### Volterra



Code	Size CC	Overall Size	Projection	Width	Finish	Material
4032	160 mm	172 mm	34 mm	23 mm	SC, BN, BR	zinc alloy
	320 mm	338 mm	29 mm	23 mm		



### Mallorca



Code	Size CC	Overall Size	Projection	Width	Finish	Material
4034	160 mm	178 mm	35 mm	4 - 9 mm	BN, BR, BRS	zinc alloy
	320 mm	338 mm	35 mm	4 - 9 mm		



### Madrid



Code	Size CC	Overall Size	Projection	Width	Finish	Material
4037	160 mm	173 mm	32 mm	6 mm	BN, BR, BRS	zinc alloy
	320 mm	330 mm	32 mm	6 mm		



### Milano



Code	Size CC	Overall Size	Projection	Width	Finish	Material
4038	160 mm	177 mm	35 mm	14 mm	BN, BR, BRS	zinc alloy
	320 mm	337 mm	35 mm	14 mm		



### Malaga



Code	Size CC	Overall Size	Projection	Width	Finish	Material
4039	160 mm	167 mm	29 mm	24 mm	BN, BR, BRS	zinc alloy
	320 mm	329 mm	29 mm	24 mm		

**Alessio**



Code	Size CC	Overall Size	Projection	Width	Finish	Material
<b>4385</b>	480 mm	492 mm	38 mm	14 mm	SC	aluminium
	544 mm	556 mm	38 mm	14 mm		
	736 mm	748 mm	38 mm	14 mm		



Code	Size CC	Overall Size	Projection	Width	Finish	Material
<b>4390/224</b>	224 mm	260 mm	20 mm	13 mm	SC	Aluminium

**Dimaro**



Code	Size CC	Overall Size	Projection	Width	Finish	Material
<b>4400</b>	128 mm	142 mm	26 mm	21 mm	BN	zamak
	160 mm	174 mm	26 mm	21 mm		
	192 mm	206 mm	26 mm	21 mm		
	224 mm	238 mm	26 mm	21 mm		
	256 mm	270 mm	26 mm	21 mm		



**Livo**



Code	Size CC	Overall Size	Projection	Width	Finish	Material
<b>4420</b>	128 mm	160 mm	42 mm	15 mm	BMN	aluminium
	160 mm	192 mm	42 mm	15 mm		
	224 mm	256 mm	42 mm	15 mm		
	256 mm	288 mm	42 mm	15 mm		
	320 mm	352 mm	42 mm	15 mm		
	448 mm	480 mm	42 mm	15 mm		



**Hamar**



Code	Size CC	Overall Size	Projection	diameter	Finish	Material
<b>STSI500</b>		1500 mm	63 mm	25 mm	SS	SS =
BN001					BN and PC	Stainless
PC001						Steel
						and
						zamak

Can be cut to size

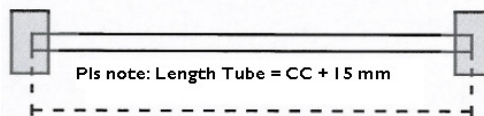

Matches Viking Professional Series



**Alda  
G' rail**

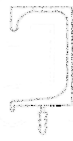

Code	Overall Size	Width	height	Finish	Material
<b>4520</b>	3 m	20 mm	35 mm	Anodised grey Raw Mill Finish	aluminium

**Armino  
L' rail**

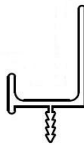

Code	Overall Size	Width	Height	Finish	Material
<b>4530</b>	3 m	21 mm	30 mm	Anodised grey Raw Mill Finish	aluminium

**Molise V rail**

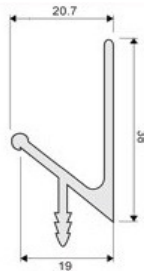

Code	Overall Size	Width	Height	Finish	Material
<b>4540</b>	3 m	19 mm	38 mm	Anodised grey Raw Mill Finish	aluminium

**Calabria Top rail**

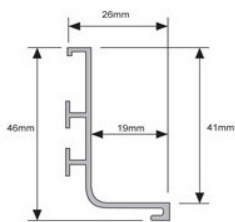

Code	Overall Size	Width	Height	Finish	Material
<b>4550/2M</b>	2 m	26 mm	46 mm	Anodised grey Raw Mill Finish BL, WH	aluminium
<b>4550/4M</b>	4 m				

**Trentino centre  
rail**

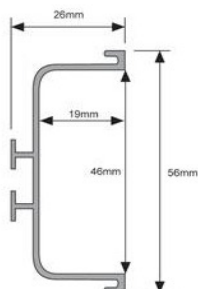

Code	Overall Size	Width	Height	Finish	Material
<b>4555/2M</b>	2 m	26 mm	56 mm	Anodised grey Raw Mill Finish BL, WH	aluminium
<b>4555/4M</b>	4 m				



Code		Overall Size	Width	Height	Finish	Material
<b>BR45</b>		Fixing bracket	42 x 42 mm	13 mm		steel
<b>SR45</b>		Screw	M4 x 8 mm			steel



Code	Size CC	Overall Size	Projection	Width	Finish	Material
<b>5003</b>	64 mm	77 mm	12 mm	39 mm	Antique	zinc alloy



Code	Size CC	Overall Size	Projection	Width	Finish	Material
<b>5005</b>	64 mm	89 mm	16 mm	30 mm	PER, BL	zinc alloy



Code	Size CC	Overall Size	Projection	Width	Finish	Material
<b>5006</b>	128 mm	164 mm	44 mm	19 mm	PEC	zinc alloy



Code	Size CC	Overall Size	Projection	Width	Finish	Material
<b>6010</b>		100 mm	37 mm	100 mm	SS	Stainless
		200 mm	37 mm	200 mm	BL	Steel
		300 mm	37 mm	300 mm		



Code	Size CC	Overall Size	Projection	Width	Finish	Material
<b>7001</b>	96 mm	105 mm	38 mm	10 mm	PE	Steel
	128 mm	135 mm	38 mm	10 mm		



## Knobs



Code	Diam	Overall Size	Projection	Width	Finish	Material
<b>7002/40</b>	40 mm		60 mm		PE	Steel

Code		Overall Size	Projection		Finish	Material
<b>7002/76</b>		76 mm	40 mm		PE	Steel

Code			Projection	Width	Finish	Material
<b>1112</b>			20 mm	25 x 25 mm	BN	zinc alloy

Code			Projection	Width	Finish	Material
<b>1114</b>			24 mm	19 x 19 mm	SC	zinc alloy

Code		Overall Size	Projection	Width	Finish	Material
<b>1115</b>		25 x 25 mm	24 mm	9 mm	SN,SC	zinc alloy

Code	size		Projection	Diameter	Finish	Material
<b>1160</b>	S		23 mm	17 mm	BN,SC	zinc alloy
	L		26 mm	25 mm		

Code	size		Projection	Diameter	Finish	Material
<b>1161</b>			23mm	12 mm	SC	zinc alloy

Code	size		Projection	Diameter	Finish	Material
<b>1162</b>			20 mm	25 mm	SC	zinc alloy





Code		Overall Size	Projection	Width	Finish	Material
<b>I164</b>		35 mm	18 mm	8 mm	SC	zinc alloy



Code	size		Projection	Diameter	Finish	Material
<b>I165</b>	L		26 mm	29 mm	BN,SC	zinc alloy



Code		Overall size	Projection		Finish	Material
<b>I167</b>		19 x 19 mm	25 mm		SC	zinc alloy



Code	Size CC	Overall Size	Projection	Width	Finish	Material
<b>I168</b>	32 mm	44 mm	20 mm	8 mm	BN,SN,SC	zinc alloy



Code			Projection	Diameter	Finish	Material
<b>I179-22</b>			28 mm	22 mm	BN	zinc alloy



Code		Overall Size	Projection		Finish	Material
<b>I184</b>		60 x 60 mm	22 mm		BN	zinc alloy



Code		Overall Size	Projection		Finish	Material
<b>I185</b>		25 x 25 mm	23 mm		SC, BN	zinc alloy



Code		Overall Size	Projection		Finish	Material
<b>I186</b>		31 x 31 mm	25 mm		BN	zinc alloy



Code	Size CC	Overall Size	Projection		Finish	Material
<b>I187</b>	32 mm	56 mm	25 mm		BN,SN,SC	zinc alloy



Code			Projection	Width	Finish	Material
<b>1194</b>			25 mm	20 x 21 mm	BN,SN,SC	zinc alloy



Code			Projection	diameter	Finish	Material
<b>1223</b>			25 mm	16 mm	White Black	Duron

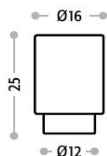

Code	Size CC	Overall Size	Projection	Width	Finish	Material
<b>1299</b>	32 mm	41 mm	20 mm	10 mm	BN	zinc alloy



Code			Projection	Diameter	Finish	Material
<b>3801</b>			25 mm	33 mm	PE, BL	zinc alloy



Code			Projection	Diameter	Finish	Material
<b>3804</b>			25 mm	33 mm	PER	zinc alloy



Code			Projection	Diameter	Finish	Material
<b>3805</b>			25 mm	33 mm	PEC	zinc alloy



Code		Overall Size	Projection		Finish	Material
<b>3905</b>		26 x 18 mm	16 mm		SC	zinc alloy



## Flush Pulls



Code	Size CC	Overall Size	Depth	inside dim.	Finish	Material
<b>I132</b>	64 mm	76x42 mm	10 mm	18x48 mm	BN,SC	zinc alloy
	96 mm	108x42 mm	10 mm	18x80 mm		
	128 mm	142x42 mm	10 mm	18x111 mm		



Code	Overall Size	Depth	inside dim.	Finish	Material
<b>I141</b>	100 x 38 mm	13 mm	68 x 18 mm	BN,SC	zinc alloy
	135 X 38 mm	13 mm	95 x 18 mm	BSC, BL	
	165 x 50 mm	13 mm	115 x 25 mm		



Code	Overall Size	Depth	inside dim.	Finish	Material	
<b>I145</b>	96 mm	124 mm	13 mm	21x76mm	BN, SC	aluminium
	160 mm	188 mm	13 mm	21x140mm	BL, BSC	
	224 mm	252 mm	13 mm	21x204mm		
	288 mm	316 mm	13 mm	21x268mm		



Code	Overall Size	Depth	inside dim.	Finish	Material
<b>IN 16 410</b>	135x70	17 mm	120 x 46mm	SS	stainless steel



Code	Overall Size	Depth	inside dim.	Finish	Material
<b>IN 16 416</b>	300x55mm	17 mm	250 x 25mm	SS	stainless steel



Code	Overall Size	Depth	inside dim.	Finish	Material
8002/190	190x45mm	12mm	125x26mm	BN,SC,BR, BL,PC	zinc alloy

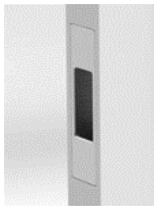

Code	Overall Size	Depth	inside dim.	Finish	Material
BN8001/92	92x26mm	12mm	38 x 18mm	BN,SC,BR, BL,PC	zinc alloy



Code	Size CC	Overall Size	Depth	Finish	Material
1150	160 mm	171x52 mm	14 mm	SC	zinc alloy

for 18 mm board only



Code	Overall Size	Depth	inside dim.	Finish	Material
IN 16 316	30 mm	29 mm	20 mm	SS	stainless steel

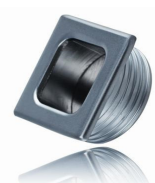

Code	diam	Overall Size	Depth	inside dim.	Finish	Material
3038S	24 mm	26 x 26 mm	11 mm	16 x 16 mm	BN,SC, BSC BL	zinc alloy



Code	diam	Overall Size	Depth	inside dim.	Finish	Material
3038L	40 mm	46 x 46 mm	11 mm	26 x 26 mm	BN,SC,BL	zinc alloy

## Hooks



Code	diam	Diameter	Height	Projection	Finish	Material
IN 14 60I		16mm	85 mm	45 mm	BL, SC, BN	Aluminium

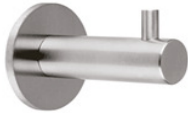

Code	diam	Diameter	Projection		Finish	Material
IN 14 500		14 mm	48 mm		SS	stainless steel

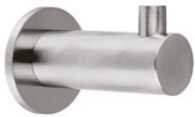

Code	diam	Diameter	Projection		Finish	Material
IN 14 50I		19 mm	48 mm		SS	stainless steel

## Doorstops



Code		Diameter	Height		Finish	Material
5025		47 mm	25 mm		BN, SC	zinc alloy



Code		Diameter	Length		Finish	Material
5029C		30 mm	76 mm		BN, SC	zinc alloy

doorstop with catch



Code		Diameter	Height		Finish	Material
5031		19 mm	50 mm		SS	stainless steel



Code		Diameter	Height		Finish	Material
5034		10 mm	83 mm		BN	zinc alloy



Code		Diameter	Height		Finish	Material
5036		16 mm	83 mm		BN, SC BSC, BL	aluminium



## Doorstops



Code	Diameter	Height	Finish	Material
IN 13 106 20	20 mm	22 mm	SS	stainless steel
IN 13 106 25	25 mm	23 mm		steel



Code	Diameter	Height	Finish	Material
IN 13 186	35 mm	60 mm	SS	stainless steel



Code	Diameter	Height	Finish	Material
IN 13 121 30	30 mm	40 mm	SS	stainless steel



Code	Diameter	Height	Finish	Material
IN 13 355	47 mm	30 mm	SS	stainless steel



Code	Diameter	Height	Finish	Material
IN 13 185	30 mm	30 mm	SS, BL	stainless steel



Code	Diameter	Height	Finish	Material
IN 13 185	50 mm	30 mm	SS, BL	stainless steel



Code	Diameter	Height	Finish	Material
IN 13 010	90x75	110 mm	SS	stainless steel

## Pull handles

back to back

### Locarno



Code	Size CC	Overall Size	Projection	Width	Finish	Material
4035	160 mm	184 mm	43 mm	13 mm	BN, SC, BL	Aluminium
	224 mm	248 mm	43 mm	13 mm		

interior only

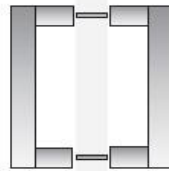

Back to back



Code	Size CC	Overall Size	Projection	Width	Finish	Material
IN 07 185	250 mm	290 mm	66mm	30 mm	SS, BL	stainless steel



Please refer to our hardware price list for handle screws, brackets, shelf supports, ball bearing sliders, aluminium legs, benchtop connectors, cabinet locks, etc.

