

AC-Q4x Family
Vandal Resistant
Stand-Alone controllers

Instruction Manual

Models:

AC-Q41H/HB

AC-Q41SB

AC-Q42H/HB

AC-Q42SB

AC-Q44



December 2006

ROSSLARE
SECURITY PRODUCTS

Table of Contents

1. General Information	4
1.1 INTRODUCTION	4
1.2 CONTROLLER TYPES	4
1.3 BOX CONTENT	5
1.4 ANCILLARY EQUIPMENT	5
1.5 TECHNICAL SPECIFICATIONS	6
1.6 KEY FEATURES	7
1.7 FRONT PANEL DESCRIPTION	8
2. Installation	9
2.1 MOUNTING THE CONTROLLER	9
2.2 WIRING THE CONTROLLER	10
2.2.1 Pre-wired Models.....	10
2.2.2 Terminal Block Models	15
3. Operation	19
3.1 MODES OF OPERATION.....	19
3.1.1 Normal Mode (Default)	19
3.1.2 Secure Mode	19
3.1.3 Bypass Mode.....	20
3.2 USER LEVELS	20
3.2.1 Normal User.....	20
3.2.2 Secure User	21
3.2.3 Master User	21
3.3 SWITCHING OPERATIONAL MODES	21
3.3.1 From Normal to Secure Mode	21
3.3.2 From Secure to Normal Mode	22
3.3.3 From Normal to Bypass Mode.....	22
3.3.4 From Bypass to Normal Mode.....	23
3.4 SPECIAL OPERATIONAL FEATURES	23
3.4.1 Auxiliary Input & Output.....	23
3.4.2 Request to Exit Button (REX)	23
3.4.3 Tamper Feature	24
3.4.4 Lockout Feature (Keypad / Card Tamper).....	24
3.4.5 BL-D40 External Sounder	25

Table of Contents

4. Programming	26
4.1 INTRODUCTION	26
4.1.1 Entering the Programming Mode	28
4.1.2 Exiting the Programming Mode	28
4.2 CHANGING THE OPEN CODE	29
4.3 CHANGING THE AUXILIARY CODE	29
4.4 CHANGING THE PROGRAMMING CODE	30
4.5 CHANGING THE NORMAL/SECURE CODE	31
4.6 CHANGING THE NORMAL/BYPASS CODE	31
4.7 SETTING FAILSAFE/SECURE OPERATION	32
4.8 SETTING AUXILIARY MODES	33
4.8.1 General	33
4.8.2 Quick Reference Guide for Auxiliary Mode Setting	35
4.8.3 Detailed Reference Guide	36
4.9 KEYPAD HEATER OPERATION	41
4.10 SETTING THE LOCKOUT FEATURE	41
4.11 BACKLIGHT and LED BEHAVIOR	43
4.12 ENROLLING CODES	43
4.12.1 Primary Codes Definition	43
4.12.2 Secondary Codes Definition	44
4.12.3 Primary and Secondary Codes Enrolling Methods	44
4.12.4 Standard Method for Codes Enrolling	45
4.12.5 Search Method for Codes Enrolling	46
4.13 DELETING CODES	47
4.13.1 Standard Method for Deleting Codes	47
4.13.2 Search Method for Deleting Codes	47
4.14 RELAY CODES ASSIGNMENT	49
4.14.1 Relay Code Assignment using Standard Method	49
4.14.2 Relay Code Assignment using Search Method	50
4.15 PIN CODE LENGTH / FACTORY DEFAULT SETTINGS	51
4.16 REPLACING A PROGRAMMING CODE	52
4.17 REPLACING A NORMAL/SECURE CODE	52
Appendix A. Limited Warranty	53
Appendix B. Technical Support	55

1. General Information

1.1 INTRODUCTION

The AC-Q4x series Access Control units are vandal resistant stand-alone controllers. All the units are water resistant and suitable for indoor or outdoor mounting. The unit(s) accepts up to 500 users and allows entry via a personal identification number (PIN) and / or by presenting a proximity card.

1.2 CONTROLLER TYPES

The different types of control units described in this manual are:

- Type 41 is PIN only
- Type 42 is PIN and proximity card
- Type 44 is PIN and proximity card, with Piezo contacts

	Heater	Relay Current	Backlight	Keypad Type	Proximity
AC-Q41H	✓	2A	✗	Standard	✗
AC-Q41HB	✓	2A	✓	Standard	✗
AC-Q41SB	✓	2A	✓	Standard	✗
AC-Q42H	✓	2A	✗	Standard	✓
AC-Q42HB	✓	2A	✓	Standard	✓
AC-Q42SB	✓	2A	✓	Standard	✓
AC-Q44	✗	2A	✗	Piezo	✓

1.3 BOX CONTENT

Before beginning verify that all of the following is in the box, if anything is missing please report the discrepancy to your nearest Rosslare Office.

- One unit
- One Drilling Template (Label/Sticker)
- One security spline key
- One security hex screw
- Four mounting screws and wall plugs

1.4 ANCILLARY EQUIPMENT

The following ancillary equipment may be required to complete your installation:

- Electric Lock Strike Mechanism - fail safe (power to lock) or fail secure (power to open).
- Power Supply with Backup Battery - 12 to 24 VDC (from a regulated power supply) or 16 to 24 VAC (from a transformer).
- Request to Exit (REX) Button (optional) - normally open type; switch is closed when pressed.
- BL-D40 External Sounder (optional) - provides siren, bell, and chime.
- Magnetic Contact (optional) - installed for door monitor capabilities.

1.5 TECHNICAL SPECIFICATIONS

		AC-Q41H	AC-Q41HB	AC-Q42H	AC-Q42HB	AC-Q41SB	AC-Q42SB	AC-Q44
Input Voltage	VDC	12-24 VDC						
	VAC	12-24 VAC		16-24 VAC		12-24 VAC	16-24 VAC	
Maximum Input Current (12VDC)	Heater Off	100mA	130mA	125mA	145mA	130mA	145mA	125mA
	Heater On	580mA	610mA	605mA	625mA	610mA	625mA	N/A
Standby Input Current (12VDC)	Heater Off	40mA	70mA	65mA	85mA	70mA	85mA	65mA
	Heater On	520mA	550mA	545mA	565mA	550mA	565mA	N/A
Maximum Relay Current	2A							
REX Input	Normally Open(Dry Contact)							
Aux. Input	Normally Open(Dry Contact)							
Max. Proximity read range	N/A		65 mm (2.5")		N/A		65 mm (2.5")	
Proximity Modulation	N/A		ASK at 125 KHz		N/A		ASK at 125 KHz	
Proximity card compatibility	N/A		26 Bits EM cards		N/A		26 Bits EM cards	
LED Indicators	Two 3 colored LED (Mode and Door)							
Operating Temperatures	-20°C to +60°C (-4°F to +140°F)							
Outdoor Usage	Water resistant, meets IP-54					Weather resistant, meets IP-65, Epoxy potted		
Size	H 120 x W 76 x T 27 mm		H 4.72" x W 3" x T 1.06"		H 120 x W 76 x T 22 mm		H 4.72" x W 3" x T 0.85"	
Weight	440 gr. 1 lbs.				521 gr. 1.18 lbs.			

1.6 KEY FEATURES

- 500 Users
- Water and vandal resistant
- Programmable Backlight and active LED control (option "B")
- Three user levels: normal; secure; master
- Three modes of operation: normal; bypass; secure
- Integrated keypad for PIN entry (Piezoelectric - Q44 only)
- Integrated proximity card reader (Q42 and Q44 only)
- Selectable PIN code length up to 8 digits
- Auxiliary input and auxiliary output
- Ten auxiliary modes including: door ajar; forced door; shunt; door monitor; normal / secure; LED control
- Input for Request to Exit (REX) button
- Code search feature for easy maintenance of user codes
- Internal buzzer
- Vandal proof screw (special tool supplied)
- Two tri-colored status/programming LED indicators
- Built-in case and back tamper protection
- Lockout feature on wrong entries (Keypad / Card Tamper)
- Bell, chime, siren and strobe features available with BL-D40
- Programmable siren time (with BL-D40)
- Programmable lock strike release time.
- Supplied with mounting template for easy installation

1.7 FRONT PANEL DESCRIPTION

Controls and indicators of all controller versions are identical. See Figure 1 (excluding the antenna, which is unique to Q42 and Q44).

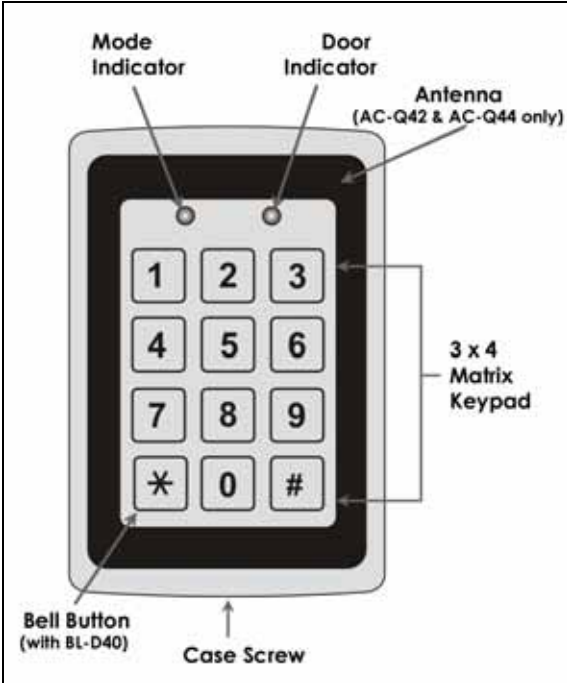

Figure 1: Front Panel

2. Installation

2.1 MOUNTING THE CONTROLLER

Prior to starting, select the location where the controller unit is to be mounted. Perform the following steps:

- 1) Open the controller by loosening and removing the case security screw at the bottom using the security spline key.
- 2) Depending on the type of installation, gang box or panel mount, drill the respective holes in the rear cover. See Figure 2 for details. For gang box mounting, drill two holes marked "A". For flat panel mount, drill four holes marked "B".

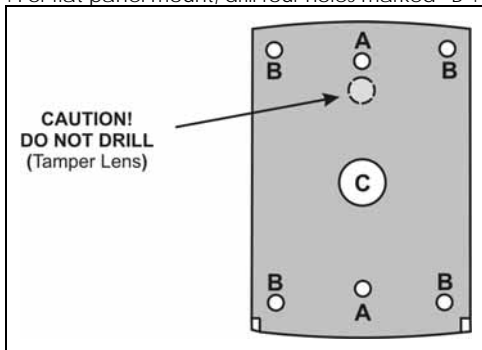

Figure 2: Drilling Holes Identification



Note:

The central hole, marked "C" is for routing the wiring to the controller.

- 3) Use the provided drilling template to accurately locate and drill the required holes in the wall or panel.
- 4) Use the hardware provided to mount the back plate on the wall or on a gang box. Be sure to route the wiring via the large center hole in the back plate. Check for level.
- 5) Wire the controller according to the type supplied: pre-wired cable or terminal block terminal, as instructed hereafter.
- 6) Once wired, replace the controller back onto its back plate and secure using tamper-proof screw and special tool, supplied with the hardware.

2.2 WIRING THE CONTROLLER

The controllers are provided either with a sixty-centimeter, pre-wired, 10-conductor cable or with a screw-type terminal block. Specifically:

Pre-wired cabling Models

AC-Q41SB
AC-Q42SB
AC-Q44

Terminal block models

AC-Q41H/HB
AC-Q42H/HB

2.2.1 Pre-wired Models

These controllers come with a 60cm 24-AWG wiring.

Wire according to the following steps:

- 1) Cut and strip the conductors to the necessary length.
- 2) Splice the controller pigtail wires to the corresponding ancillary devices and insulate each connection, including unused wires. Refer to the wiring color guide table below and to the wiring diagrams, depending on the desired application:

Wiring the Lock Strike Relay & REX (Figure 3)

Wiring for Auxiliary Input & Output (Figure 4)

Wiring for the BL-D40 External Sounder (Figure 5)

Wiring Color Guide

Color	Description
Red	V input
Black	Ground
Green	REX / BL
White	In / Monitor
Purple	Lock: Com
Gray	Lock: N.O.
Brown	Lock: N.C.
Blue	Aux: Com
Yellow	Aux: N.O.
Orange	Aux: N.C.

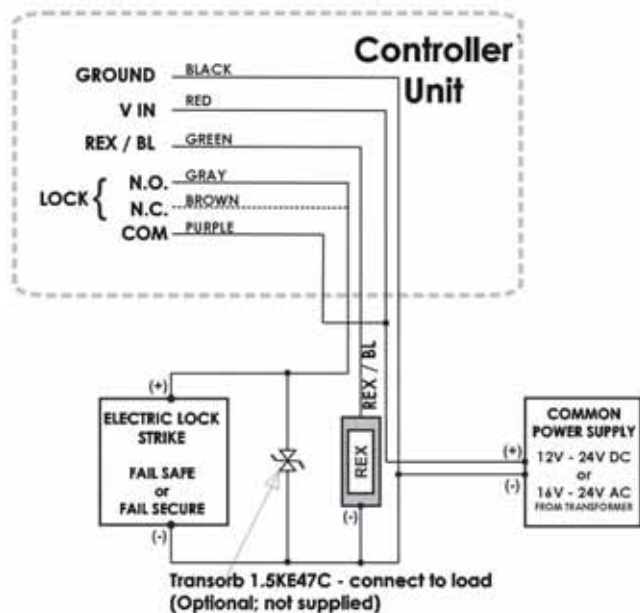

Figure 3: Pre-Wired Connection for Lock Strike Relay & REX

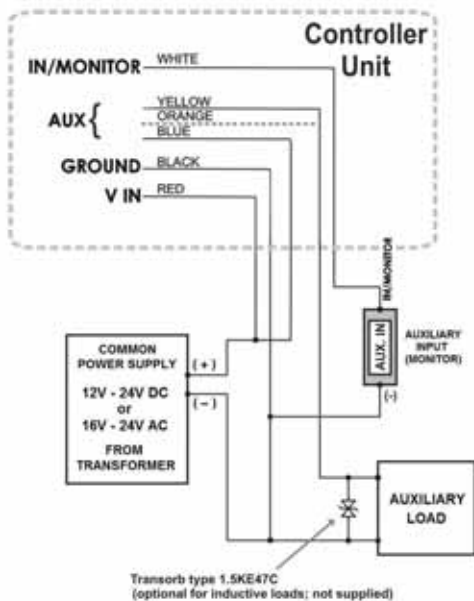

Figure 4: Pre-Wired Connection for Auxiliary Input & Output

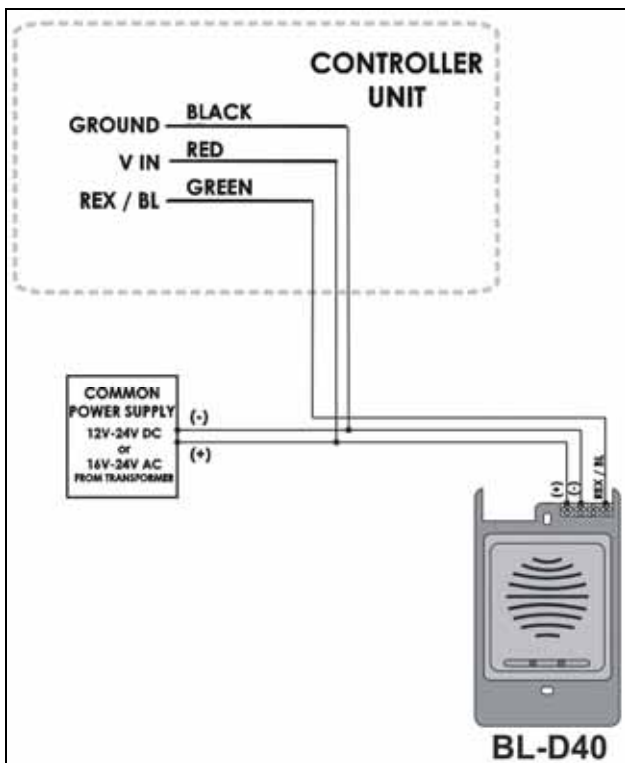

Figure 5: Pre-Wired Connection for the BL-D40 External Sounder

2.2.2 Terminal Block Models

These controllers come with removable terminal blocks that are pushed on pins on the motherboard of the controllers. Wire according to the following steps:

- 3) Route the wires or cable through the large hole in the back cover. See Figure 6. Connect the terminal blocks as shown.
- 4) Wire the cabling according to the following diagrams.
 - Wiring the Lock Strike Relay & REX (Figure 7)
 - Wiring for Auxiliary Input & Output (Figure 8)
 - Wiring for the BL-D40 External Sounder (Figure 9)

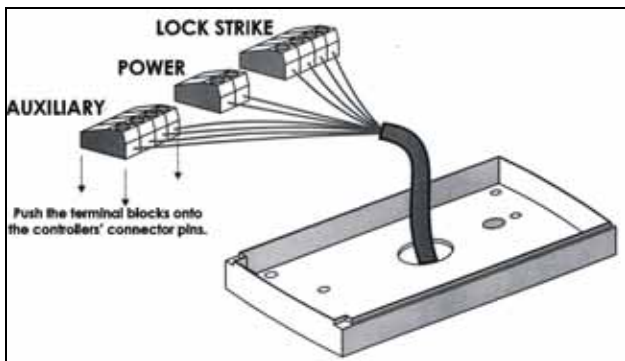

Figure 6: Connections to Terminal Blocks

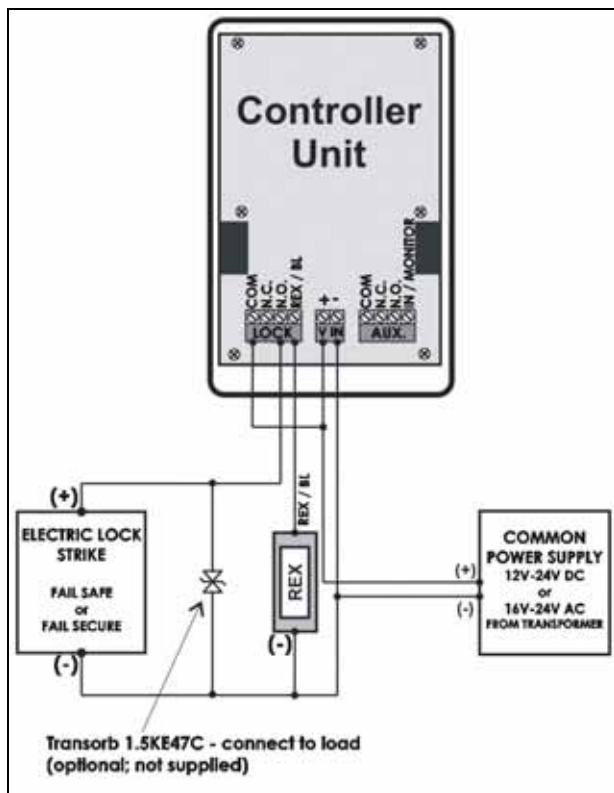

Figure 7: Terminal Block Wiring of the Lock Strike Relay & REX

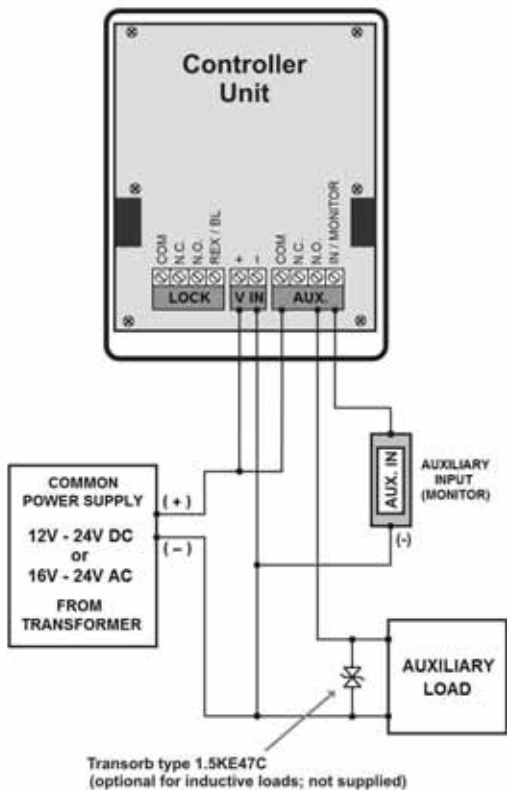

Figure 8: Terminal Block Wiring of the Auxiliary Input & Output

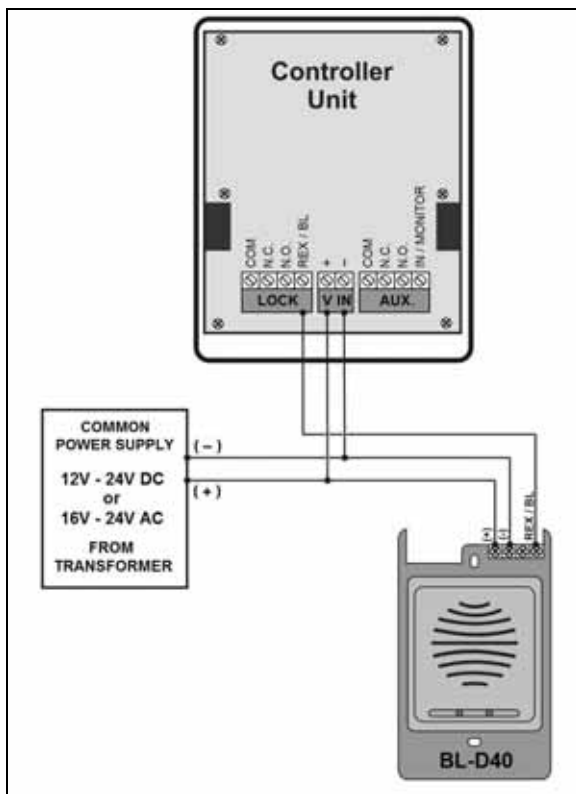

Figure 9: Terminal Block Wiring of the BL-D40 External Sounder

3. Operation

**Note:**

- In the Operation chapter, “code” refers to a PIN code or proximity card depending on the unit you have.
- Memory slots can be a proximity card or PIN code depending on the unit you have.

3.1 MODES OF OPERATION

The Control units have three modes of operation. These are indicated by the color of the Mode indicator:

3.1.1 Normal Mode (Default)

- Mode indicator is green.

In normal mode, the door is locked until a valid primary code is presented to the controller.

The controller can only be programmed in normal mode.

3.1.2 Secure Mode

- Mode indicator is red.

Only secure and master users can access the premises in secure mode.

A secure user must enter a primary and secondary code to gain entry. Once the primary code has been entered, the Door indicator will flash green for 10 seconds. During this time, the secondary code must be entered. A master user only needs to enter his code to gain entry.

3.1.3 Bypass Mode

- Mode indicator is orange.

In bypass mode, access to the premises is dependent on the Lock Strike relays; that is, if the relay is programmed for failsafe operation or fail-secure operation.

When the Lock Strike relay is programmed for fail secure operation, the door is locked until the star button (*) is depressed.

When the Lock Strike relay is programmed for failsafe operation, the door is constantly unlocked.

In case of power failure, once the power is restored, the controller will return to normal mode, for security reasons.

3.2 USER LEVELS

AC-Q4x series Access Control units accept up to 500 users and provide entry via the use of codes. Each user is allocated two memory slots: Memory Slot 1 (primary code) and Memory Slot 2 (secondary code).

The way in which the two memory slots are programmed, determines a user's access level and also establishes access is granted for each of the three modes of operation.

There are three user levels:

3.2.1 Normal User

A normal user only has a primary code and is granted access only when the controller is in its normal or bypass mode.

3.2.2 Secure User

A secure user must have a primary and secondary code assigned, and the two codes must not be the same. The secure user can gain access in any mode of operation. In normal mode the secure user must use the primary code to gain entry. In secure mode, the secure user must first enter the primary and then the secondary code, in order to gain entry.

3.2.3 Master User

A master user must have identical primary and secondary codes assigned. The codes are entered with the same proximity card or the same PIN. The master user can gain access during any mode of operation by entering their code only once.

3.3 SWITCHING OPERATIONAL MODES

The three modes of operation defined above, can be changed through a few steps.

3.3.1 From Normal to Secure Mode

The default factory setting for the normal / secure code is 3838.

1) Enter the normal / secure code.

Mode  Door
Green

- Mode indicator will flash red.

Mode  Door
Red

2) Depress the # key to confirm the Mode change.

- Mode indicator is red.

Mode  Door
Red

The auxiliary input of the controller can also be used to switch the mode of operation from secure to normal and vice versa, if the auxiliary input is selected it de-activates the Norma/Secure mode code. Refer to Setting the Auxiliary Mode, paragraph 4.8.

3.3.2 From Secure to Normal Mode

The default factory setting for the normal / secure code is 3838.

- 1) Enter the normal / secure code.
 - Mode indicator will flash green.
- 2) Depress the # key to confirm the Mode change.
 - Mode indicator will turn green.

Mode  Door
Red

Mode  Door
Green

Mode  Door
Green

The auxiliary input of the controller can also be used to switch the mode of operation from secure to normal and vice versa, if the auxiliary input is selected it de-activates the Norma/Secure mode code. Refer to Setting the Auxiliary Mode, paragraph 4.8.

3.3.3 From Normal to Bypass Mode

By default, there is no normal / bypass code. The normal / bypass code must first be programmed to use this function. Refer to paragraph 4.6 to create / modify the normal / bypass code.

- 1) Enter the normal / bypass code.
 - Mode indicator will flash orange.
- 2) Depress the # key to confirm the mode change.
 - Mode indicator will turn orange.

Mode  Door
Green

Mode  Door
Orange

Mode  Door
Orange

3.3.4 From Bypass to Normal Mode

1) Enter the normal / bypass code.



- Mode indicator will flash green.



2) Depress the # key to confirm the mode change.

- Mode indicator will turn green.



3.4 SPECIAL OPERATIONAL FEATURES

Some installation-specific features are exercised, as required by the system. These features are implemented as shown in Figures 4 thru 9.

3.4.1 Auxiliary Input & Output

For optimum usability in different applications, the controller's auxiliary input and output can be configured in ten different modes of operation. Refer to Setting the Auxiliary Mode, on paragraph 4.8.

3.4.2 Request to Exit Button (REX)

The REX pushbutton is located within the premises and is used to open the door from the inside. It is usually located in a convenient location (e.g.: next to the door or at a receptionist's desk). The door chime (if enabled) in the BL-D40 does not sound when the REX pushbutton is used to open the door.

The function of the REX pushbutton depends on the Lock Strike relay, whether it is programmed for failsafe or for fail secure operation.

Fail Secure Operation: from the moment the REX pushbutton is depressed, the door will be unlocked until the Lock Strike release time has elapsed. After this time, the door will be locked, even if the REX pushbutton has not been released.

Failsafe Operation: from the moment the REX pushbutton is depressed, the door will be unlocked until the REX pushbutton is released. In this case the Lock Strike relay only begins its countdown once the REX pushbutton has been released. This feature is designed to keep the door open, when used in conjunction with fire systems.

3.4.3 Tamper Feature

In case the controller is forcibly opened or the controller is removed from the wall, a tamper event is triggered. A tamper signal is sent to the BL-D40.

If the BL-D40 External Sounder receives a tamper event signal, it will activate a tamper output and a strobe light. The siren time can be easily programmed in the controller from 0 to 9 minutes.

The tamper event can activate the auxiliary output if the controller is in Auxiliary Mode 3. Refer to the Quick Reference Guide for Auxiliary Mode Setting table in paragraph 4.8.2 below.

3.4.4 Lockout Feature (Keypad / Card Tamper)

In case the controller is presented with wrong codes, (PIN or Card) consecutively several times the unit goes into lockout mode.

When a lockout occurs, the controller keypad and reader are deactivated so no codes can be entered until the set lockout period expires.

Operation

During Lockout, Mode LED is Off, Door LED flashes Red, and the controller beeps every two seconds.

Refer to programming menu 6 for detailed programming of this feature.

3.4.5 BL-D40 External Sounder

The BL-D40 External Sounder is designed for indoor use only and installed within the secured premises. The Sounder can be powered by a 12 to 24 VDC power supply or by a 16VAC transformer. The BL-D40 is capable of emitting four different types of audible and visual alerts: bell, chime, siren and strobe light.

- The bell sounds when the controller's bell button is depressed.
- The door chime can be programmed to sound whenever a valid code is entered as well as for a door held open alert.
- The siren can be programmed to sound when the controller is tampered with (opened or removed from the wall). The length of the siren can also be programmed in the controller.

The controller communicates with the BL-D40 via a Rosslare proprietary protocol. If the BL-D40 receives an unrecognized code over its communication line or communications between the controller and the BL-D40 are severed, the strobe will flash repeatedly, until the communication problem has been resolved.

4. Programming

**Note:**

- In the Programming chapter, “code” refers to a PIN code or proximity card depending on the unit you have.
- When entering a PIN or presenting a proximity card is mentioned, the meaning may vary between units.

4.1 INTRODUCTION

Programming an AC-Q4x series Access Control unit is done solely via the unit’s keypad-driven Programming Menu System. To reach the Programming Menu System, the controller must first be placed into Programming Mode. Refer to Entering Programming Mode, paragraph 4.1.1

During the manufacturing process, certain codes and settings are pre-programmed. These settings are the called default factory settings.

Programming

The table below shows all the programming menus, with default factory codes and settings.

Menu No.	Description	Default				Page No.
		4 Digit	5 Digit	6 Digit	4-8 Digits	
1	Change open code	2580	25802	258025	25802580	29
2	Change auxiliary code	0852	08520	085208	08520852	29
3	Change program code	1234	12341	123412	12341234	30
4	Change normal / secure code	3838	38383	383838	38383838	31
5	Change normal / bypass code	-				31
6	Change door release time	0004				32
6	Define auxiliary inputs / outputs	2004				33
6	Enable or disable keypad heater	3000				41
6	Set Lockout Feature	4000				41
6	Backlight and LED Behavior	5100				43
7	Enroll proximity cards, PIN or both	-				43
8	Delete proximity cards or PIN	-				47
9	Code assignment with strike/auxiliary	-				49
0	Return to factory defaults / Change PIN code Length	-				51

Table 1 programming Menu

4.1.1 Entering the Programming Mode

Note:

- The controller must be in normal mode to enter the programming mode.
- The factory default 4-digit programming code is **1234**.
- If a programming code is not entered within 5 seconds, the controller will return to its normal mode.

1) Depress the # key twice, within 0.5 seconds.

- Mode indicator will turn off.
- Door indicator will turn red.

Mode Door
Red

2) Enter your programming code.

If the programming code is valid, the door Indicator will turn green and the controller will enter the programming mode.

Mode Door
Green

4.1.2 Exiting the Programming Mode

Note:

- Wrong entries may reset the controller back to its normal mode.
- If no key is pressed for 1 minute, while in programming mode, the controller will exit the programming mode and return to its normal mode.

To exit the programming mode, depress the # key twice, within 0.5 seconds.

- You will hear three beeps.
- The door indicator will be off.
- The mode indicator will turn green.

Mode Door
Green

The above indicates that the controller has returned to its normal mode.

Note:

While enrolling, deleting users, or while in code assignment mode, depress the # key, twice to exit the programming mode.

4.2 CHANGING THE OPEN CODE

The open code is mainly used as a method to quickly test the Lock Strike relay during installation.

The factory 4-digit default setting for the open code is **2580**.

For security reasons when the first user is added to the controller or the auxiliary code is changed, the default open code will automatically be deleted, non-default codes will not be erased automatically.



Note:

- Open code does not function in secure mode.
- Wrong entries: you will hear a long beep and the controller will return to its normal mode.
- Code 0000 will erase and deactivate the open code.

1) Enter the programming mode.

2) Depress 1 to enter Menu 1.

- The Mode indicator will turn red.

Mode   Door
Red Green

3) Enter the new code you wish to set as open code.

4) System returns to its normal mode.

- You will hear three beeps.
- The Door indicator will turn off.
- The Mode indicator will turn green.

Mode   Door
Green

4.3 CHANGING THE AUXILIARY CODE

The auxiliary code is mainly used as a method to quickly test the Auxiliary relay during installation. The default 4-Digit factory setting for the auxiliary code is **0852**.

For security reasons when the first user is added to the controller or the open code is changed, the default auxiliary code will automatically be deleted, non-default codes will not be erased automatically.



Note:

- Auxiliary code does not function in secure mode.
- Auxiliary code only works when the auxiliary mode is 0, 1, 8 or 9.
- Wrong entries: you will hear a long beep and the controller will return to its normal mode.
- Code 0000 will erase and deactivate the auxiliary code.

- | | | | |
|--|------|----------------------------------|---------------------------------------|
| 1) Enter the programming mode. | Mode | <input type="radio"/> | <input checked="" type="radio"/> Door |
| 2) Depress 2 to enter Menu 2. | | | Green |
| • The Mode indicator will turn orange. | Mode | <input checked="" type="radio"/> | <input checked="" type="radio"/> Door |
| | | | Orange Green |
| 3) Enter a new auxiliary code. | | | |
| 4) System returns to its normal mode. | | | |
| • You will hear three beeps. | | | |
| • The Door indicator will turn off. | Mode | <input checked="" type="radio"/> | <input type="radio"/> Door |
| • The Mode indicator will turn green. | | | Green |

4.4 CHANGING THE PROGRAMMING CODE



Note:

- The code 0000 is not valid; thus, the programming code cannot be erased.
- Wrong entries: you will hear a long beep and the controller will return to its normal mode.

- | | | | |
|---------------------------------------|------|----------------------------------|---------------------------------------|
| 1) Enter the programming mode. | Mode | <input type="radio"/> | <input checked="" type="radio"/> Door |
| | | | Green |
| 2) Depress 3 to enter Menu 3. | | | |
| • The Mode indicator will turn green. | Mode | <input checked="" type="radio"/> | <input checked="" type="radio"/> Door |
| | | | Green Green |
| 3) Enter the new programming code. | | | |
| 4) System returns to its normal mode. | | | |
| • You will hear three beeps. | | | |
| • The Door indicator will turn off. | Mode | <input checked="" type="radio"/> | <input type="radio"/> Door |
| • The Mode indicator will turn green. | | | Green |

4.5 CHANGING THE NORMAL/SECURE CODE



Note:

- When the auxiliary mode is 1, 2, 3 or 4, the auxiliary input takes priority over the normal/secure code.
- Wrong entries: you will hear a long beep and the controller will return to its normal mode.
- Code 0000 will erase and deactivate the normal/secure code.

1) Enter the programming mode.

Mode Door
Green

2) Depress 4 to enter Menu 4.

- The Mode indicator will flash red.

Mode Door
Red Green

3) Enter the new Normal/Secure code.

4) System returns to its normal mode.

- You will hear three beeps.
- The Door indicator will turn off.
- The Mode indicator will turn green.

Mode Door
Green

4.6 CHANGING THE NORMAL/BYPASS CODE

The normal / bypass code is also used to turn the door chime off and on. Chime only functions with the BL-D40 External Sounder.



Note:

- The chime is only heard when the Lock Strike relay is activated by a valid code entry.
- Wrong entries: you will hear a long beep and the controller will return to its normal mode.
- Code 0000 will erase and deactivate the normal/bypass code.

1) Enter the programming mode.

Mode Door
Green

2) Depress 5 to enter Menu 5.

- The Mode indicator will flash orange.

Mode Door
Orange Green

- 3) Hereafter, are four different ways to program the normal / bypass code and door chime.
- a. Disable both Bypass Code and the door chime.
Enter the code 0000.
 - b. Disable Bypass Code and enable the door chime.
Enter the code 0001.
 - c. Enable Bypass Code and disable the door chime.
Enter any code ending with 0.
 - d. Enable Bypass Code and enable the door chime.
Enter a code not ending with 0.

4) System returns to its normal mode.

- You will hear three beeps.
- The Door indicator will turn off.
- The Mode indicator will turn green.

Mode Green Door

4.7 SETTING FAILSAFE/SECURE OPERATION

In this paragraph, the failsafe / fail secure operation of the door lock and the door lock strike release time are set. Setting the sounding period for the siren feature requires a BL-D40 External Sounder.

1) Enter the programming mode.

Mode Door
Green

2) Depress 6 to enter Menu 6.

- The Mode indicator will flash green.

Mode Door
Green Green

Programming

3) Construct a code using instructions hereafter.

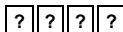

First Digit

For *fail secure* operation, the first digit is set to **0**.

For *failsafe* operation, the first digit is set to **1**.

Second Digit

Siren time, enter any number from 0 to 9 (minutes).

Third and Fourth Digits

The Lock Strike is to be released after the number of seconds entered (1 to 99).

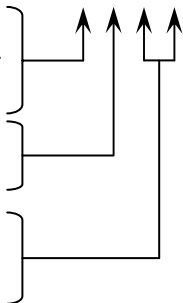

For example **0512** means: *fail secure* operation (0), with 5 minutes siren time (5) and a 12-second Lock Strike release time (12).

4) System returns to its normal mode.

- You will hear three beeps.
- The Door indicator will turn off.
- The Mode indicator will turn green.



4.8 SETTING AUXILIARY MODES

4.8.1 General

The default auxiliary setting is **2004**.

1) Enter the Programming Mode.



2) Depress 6 to enter Menu 6.

- The Mode indicator will flash green



3) Construct a code using the instructions hereafter.

The Quick Reference Guide for Auxiliary Mode

2 ? ? ?

Setting Table provides a quick reference listing for the auxiliary modes and settings.

Auxiliary Mode

Auxiliary Setting



Note:

Auxiliary Relay activation is subject to users' Auxiliary code assignment (Excluding Shunt, which is activated by all users), for more details see paragraph 4.14 RELAY CODES ASSIGNMENT.

Auxiliary Mode

In addition to the Lock Strike relay and the Lock Strike REX, the controller features an auxiliary output relay and an auxiliary input, whose function is established by the auxiliary mode selection (0 thru 9).

The auxiliary mode also determines if the auxiliary output relay is set for failsafe or for fail secure operation.

For a more detailed explanation on each auxiliary mode, refer to the Auxiliary Mode Reference table below.

Auxiliary Settings

Each of the auxiliary modes has a two-digit setting which affects the operation of the related relay(s).

4) System returns to its normal mode.

- You will hear three beeps.
- The Door indicator will turn off.
- The Mode indicator will turn green.

Mode Green Door

4.8.2 Quick Reference Guide for Auxiliary Mode Setting

Auxiliary Mode	Auxiliary Input Function	Auxiliary Output Activated by	Auxiliary Relay	Auxiliary Settings (in seconds)
0	AUX REX	Valid code or AUX REX	N.O.	01 to 99 Aux. relay release time 00 Aux. relay toggle
1	Normal/Secure switch	Valid code	N.O.	01 to 99 Aux. relay release time 00 Aux. relay toggle
2	Normal/Secure switch	Star button (*)	N.O.	01 to 99 Aux. relay release time 00 Aux. relay toggle
3	Normal/Secure switch	Tamper event	N.C.	01 to 99 Aux. relay release time 00 Aux. relay tamper activated
4	Normal/Secure switch	Direct shunt	N.O.	01 to 99 Shunt time
5	Door Monitor	Shunt	N.C.	01 to 99 Maximum shunt time
6	Door Monitor	Forced door	N.C.	01 to 99 Forced delay
7	Door Monitor	Door ajar	N.C.	01 to 99 Ajar delay
8	LED control - Green	Valid code	N.O.	01 to 99 Aux. relay release time 00 Aux. relay toggle
9	LED control - Red	Valid code	N.O.	01 to 99 Aux. relay release time 00 Aux. relay toggle

4.8.3 Detailed Reference Guide

The following are brief descriptions of each auxiliary mode. To implement the features of each mode, refer to Setting the Auxiliary Mode, paragraph 4.8.1.

AUXILIARY MODE 0

Auxiliary input function: Activates the auxiliary output

Auxiliary output activated by: Valid user code, Auxiliary code, Auxiliary input

E.g. In auxiliary mode 0, the controller can function as a two-door controller. The auxiliary relay is to be attached to the lock on the second door. The auxiliary setting defines the door open time for the second door. The auxiliary input is to be attached to the REX pushbutton for the second door. Door Monitor input feature for the second door is not enabled when using this mode.

AUXILIARY MODE 1

Auxiliary input function: Toggles normal/secure modes

Auxiliary output activated by: Valid user code, Auxiliary code

E.g. In auxiliary mode 1, the controller can function as a two-door controller. The auxiliary relay is to be attached to the lock on the second door. REX feature for the second door is not enabled when using this mode.

The auxiliary setting defines the door open time for the second door. The auxiliary input can switch the mode of operation of the controller between normal and secure mode. By connecting a switch timer or alarm system output to the auxiliary input, the controller can be automatically switched from normal mode (during office hours) to secure mode (after office hours).

AUXILIARY MODE 2

Auxiliary input function: Toggles normal/secure modes

Auxiliary output activated by: Star Button (*)

E.g. In auxiliary mode 2, the auxiliary relay can function as a general purpose time switch that can be activated when the star button (*) is depressed. The auxiliary setting establishes for how long the auxiliary relay is to be activated. The auxiliary input can switch the mode of operation of the controller between normal and secure mode. By connecting a switch timer or alarm system output to the auxiliary input, the controller can be automatically switched from normal mode (during office hours) to secure mode (after office hours).

AUXILIARY MODE 3

Auxiliary input function: Toggles normal/secure modes

Auxiliary output activated by: Alarms

E.g. In auxiliary mode 3, the auxiliary output is activated if the controller is tampered; that is, if the case is forcibly opened or removed from the wall. The auxiliary input can switch the mode of operation of the controller between normal and secure mode. By connecting a switch timer or alarm system output to the auxiliary input, the controller can be automatically switched from normal mode (during office hours) to secure mode (after office hours).

AUXILIARY MODE 4

Auxiliary input function: Toggles normal/secure modes

Auxiliary output activated by: direct shunt (explanation below)

E.g. In auxiliary mode 4, the controller is capable of bypassing an alarm zone by shunting an alarm system's door sensor. The auxiliary output is to be wired in parallel to the door sensor output. When in use, the auxiliary output is normally open and the door sensor functions normally. When a valid code is entered, the auxiliary relay shunts the door sensor for the duration of the shunt time, as defined by the auxiliary setting. If the door is left open longer than the shunt time, an alarm will be triggered.

AUXILIARY MODE 5

Auxiliary input function: Door Monitor

Auxiliary output activated by: Shunt (explanation below)

E.g. In auxiliary mode 5, the controller is capable of shunting an alarm system. In this mode, the auxiliary input is to be wired to the magnetic contact switch on the door. The auxiliary relay is wired to the alarm system. Without a valid code entered, the auxiliary relay will match the condition of the magnetic contact switch; if the door opens, the auxiliary relay will open; if the door closes, the auxiliary relay will close. When a valid code is entered, a count down for maximum shunt time, as defined by the auxiliary setting, begins; if the door is not closed before the maximum shunt time, the alarm will be triggered.

AUXILIARY MODE 6

Auxiliary input function: Door Monitor

Auxiliary output activated by: Forced entry

E.g. In auxiliary mode 6, the controller can trigger the auxiliary relay if the door has been forced. If the Siren Settings is enabled the siren will be activated.

In this mode, the auxiliary input functions as a door monitor switch and is wired to the magnetic contact switch on the door. The auxiliary relay is to be wired to the alarm system. If the door is forced open, the controller will wait for the period of the forced door delay time to elapse and then, it will activate the auxiliary relay. The auxiliary setting sets the forced door delay period.

AUXILIARY MODE 7

Auxiliary input function: Door Monitor

Auxiliary output activated by: Door Ajar (door held open)

E.g. In auxiliary mode 7, the controller can trigger the auxiliary relay, if it detects that the door has been held open (ajar) too long. In this mode the auxiliary input functions as a door monitor switch and is wired to the magnetic contact switch on the door. The auxiliary relay is to be wired to the alarm system. If the door is opened, the controller will wait for the door ajar delay time to elapse and if the door does not close prior to the end of this period, the controller will activate the auxiliary relay. The auxiliary setting defines the door-ajar time.

If the BL-D40 External Sounder is connected in the system and a door-ajar event occurs, the BL-D40 will chime every few seconds for 1 minute or until the door is closed.

AUXILIARY MODE 8

Auxiliary input function: Green LED control

Auxiliary output activated by: Valid user code, Auxiliary code

E.g. In auxiliary mode 8, the controller can function as a two-door controller and also provide indicator functionality control. The auxiliary relay is connected to the lock on the second door. The auxiliary setting defines the door open time for the second door. The auxiliary input is used to control the Door indicator. If the auxiliary input is open, the indicator will flash green; if the auxiliary input is closed, the Door indicator will flash red.

**Note:**

This mode takes control of the Door indicator LED.

The indicator LED will not be lit when:

1. A valid code is entered
2. While in secure mode, when waiting for a secondary code.

AUXILIARY MODE 9

Auxiliary input function: Red LED control

Auxiliary output activated by: Valid user code, Auxiliary code

E.g. In auxiliary mode 9, the controller can function as a two-door controller and also provide indicator functionality control. The auxiliary relay is connected to the lock on the second door. The auxiliary setting defines the door open time for the second door. The auxiliary input is used to control the indicator. If the auxiliary input is open the Door indicator will flash red; if the auxiliary input is closed the Door indicator will flash green.

**Note:**

This mode takes control of the Door indicator LED.

The indicator LED will not be lit when:

1. A valid code is entered
2. While in secure mode, when waiting for a secondary code.

4.9 KEYPAD HEATER OPERATION

⊗ NOT APPLICABLE FOR AC-Q44 (without keypad heater)

The controllers contain a built-in keypad heater. Once the heater circuitry is activated, the heater will turn on when the ambient temperature drops to $4\pm 1^{\circ}\text{C}$ and will remain on until the keypad temperature rises to $7(+2 \text{ or } -1)^{\circ}\text{C}$.

When the heater is on, the controller can operate down to an ambient temperature of -20°C . When the heater is disabled, the lowest operating temperature is 0°C .

The default setting for the keypad heater is disabled state (3000).

- 1) Enter the programming mode.
- 2) Depress 6 to enter Menu 6.
 - The Mode indicator will flash green.

Mode   Door
Green Green

- 3) Construct a code using the following instructions:

3	0	0	?
---	---	---	---

To disable the heater, the fourth digit is set to 0.
To enable the heater, the fourth digit is set to 1.

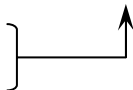

4.10 SETTING THE LOCKOUT FEATURE

In case the controller is presented with wrong codes, (PIN or Card) consecutively several times the unit goes into lockout mode.

When a lockout occurs, the controller keypad and reader are locked so no codes can be entered until the set lockout period expires.

During Lockout, Mode LED is Off, Door LED flashes Red, and the controller beeps every two seconds.

The default setting for the Lockout Feature is 4000 (Lockout Disabled)



Note:

Using the lockout feature is highly recommended, especially when selecting to use short PIN code length (4 or 5 digits).

- 1) Enter the programming mode.
- 2) Depress 6 to enter Menu 6.
 - The Mode indicator will flash green.
- 3) Construct a code using the following instructions:

Mode  Door 
 Green Green

Set the number of wrong code attempts, which will cause Lockout between 0 and 9 attempts.

Sets the Duration of the lockout, between 00 and 99, the value is multiplied by ten, resulting in 0-990 seconds

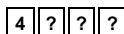

4.11 BACKLIGHT and LED BEHAVIOR

⊗ APPLICABLE FOR AC-Q4xHB/SB MODELS ONLY (backlight)

The controller allows you to define the way the units' Backlight as well as the Mode and Door LEDs will work.

To define the Backlight and LEDs operation:

- 1) Enter the programming mode.
- 2) Depress 6 to enter Menu 6.
 - The Mode indicator will flash green.



- 3) Construct a code using the following instructions:

the first digit is five indicating the backlight and Led option

the second key can be 0-3 indicating the type of activity

- Option 0 - LED Active / Backlight Off
- Option 1 - LED Active / Backlight On (default)
- Option 2 - LED and Backlight Off, both activated on any key press for ten seconds.
- Option 3 - LED Active / Backlight Dimmed, backlight activated on any key press for ten seconds.

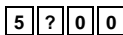

4.12 ENROLLING CODES

4.12.1 Primary Codes Definition

- Primary codes can only be enrolled to an empty user slot, a slot with no existing primary code in the controller's memory.

- A primary code must be unique; for instance, one user's primary code may not be the same as that of another user.
- Primary codes cannot be the same as system codes, such as: the normal / secure code or the open code.
- Users possessing a primary code can gain entry during normal and bypass modes.

4.12.2 Secondary Codes Definition



- Secondary codes can only be enrolled to a user slot that already includes a primary code.
- A Secondary code need not be unique; for instance, one user's Secondary code may be the same as that of another user.
- Secondary codes cannot be the same as any system codes, such as: the normal / secure code or the open code.
- Users possessing secondary codes can gain entry in any mode of operation.
- A Secondary code can be the same as the primary code of any user.



4.12.3 Primary and Secondary Codes Enrolling Methods

There are two methods used to enroll primary and secondary codes: the standard method and the code search method.



- 1) The standard method is used when the user slot number, for the user you wish to program, is known. You can program both primary and secondary codes using this method.
- 2) The code search method is mainly used when enrolling a secondary code and the user's slot code is unknown. The code search method will function only if a user's primary code is already enrolled and the secondary code is not.



4.12.4 Standard Method for Codes Enrolling

- 1) Enter the programming mode. Mode   **Door Green**

- 2) Depress 7 to enter Menu 7.
 - The Door indicator will turn orange. Mode   **Door Orange**

- 3) Enter the 3-digit user slot number into the memory (from 001 to 500) so as to enroll a primary or secondary code. ? ? ?
For example, the user slot 003 represents user no. 3.

- 4) At this time three possibilities exist:
 - a. If the selected slot has no primary code, the Mode indicator will flash green, indicating that the controller is ready to accept a primary code. Mode   **Door Orange**
Green





 - b. If the selected slot already has a primary code, but no secondary code, the Mode indicator will flash red, indicating that the controller is ready to accept a secondary code. Mode   **Door Orange**
Red

 - c. If the selected slot already has a primary and secondary code, a long beep will be heard and the controller will return to its normal mode.

- 5) Enter the code to be assigned as the primary or secondary code for this slot number.
If the code that is entered is valid, the Mode indicator will cease flashing and the controller is ready for the next 3-digit slot number (step 3) or depress the # key to move to the next slot number (step 4). If you do not wish to continue enrolling codes, depress the # key twice and the controller will return to its normal mode.

4.12.5 Search Method for Codes Enrolling

The code search method enables to quickly enroll a secondary code for a user whose primary code is known and whose slot number is unknown.

- | | |
|---|--|
| 1) Enter the programming mode. | Mode <input type="radio"/>  Door Green |
| 2) Depress 7 to enter Menu 7. | Mode <input type="radio"/>  Door Orange |
| <ul style="list-style-type: none"> • The Door indicator will turn orange. | |
| 3) Enter the 3-digit user slot number 000. | |
| <ul style="list-style-type: none"> • The Door indicator will flash orange. The controller is now waiting for the primary code of the user. | Mode <input type="radio"/>  Door Orange |
| 4) Enter the primary code belonging to the user who needs a secondary code. | |
| <ul style="list-style-type: none"> • The Mode indicator will flash red. If the primary code entered is not valid, a long beep will sound and the controller will wait for a valid primary code. | Mode   Door Red Orange |
| 5) Enter the code to be used as the secondary code. | |
| <p>If the secondary code is valid, the controller will beep three times and return to its normal mode.</p> <p>If the secondary code is invalid, the controller will produce a long beep and will wait for a valid secondary code to be entered.</p> | |







4.13 DELETING CODES

There are two methods to delete primary and secondary codes: a standard method and a search method. When deleting a user slot, both the primary code and the secondary code are erased.

**Note:**

It is recommended that a record be kept of added and deleted users. This makes it easier to keep track of user slots' status (empty or not)

4.13.1 Standard Method for Deleting Codes









- 1) Enter the programming mode.   **Door Green**
- 2) Depress 8 to enter Menu 8.
 - The Mode indicator will turn red.   **Door Orange**
- 3) Enter the 3-digit user slot code to be deleted.
 - The Mode indicator will flash red, indicating the controller is waiting for a programming code to confirm the deletion.   **Door Orange**

If the user slot is empty, a long beep will be heard and the controller will return to its normal mode.
- 4) Enter your programming code to confirm the deletion.

If the programming code is valid, three beeps will be heard and the controller will return to its normal mode.

If the programming code is invalid, a long beep will be heard and the controller will return to its normal mode.

4.13.2 Search Method for Deleting Codes





- | | | | | |
|--|---|---|---|---|
| <p>1) Enter the programming mode.</p> | <p>Mode  Door  Green</p> | | | |
| <p>2) Press 8 to enter Menu 8.</p> <ul style="list-style-type: none"> • The Mode indicator will turn red. | <p>Mode  Door  Orange</p> <p>Red Orange</p> | | | |
| <p>3) Enter 000 for user slot.</p> <ul style="list-style-type: none"> • The Door indicator will flash orange. The controller is now waiting for the primary code of the user to be deleted. | <div style="text-align: right; margin-bottom: 10px;"> <table border="1" style="border-collapse: collapse; text-align: center; width: 100px;"> <tr> <td style="width: 33px; height: 25px;">0</td> <td style="width: 33px; height: 25px;">0</td> <td style="width: 33px; height: 25px;">0</td> </tr> </table> </div> <p>Mode  Door  Orange</p> <p>Red Orange</p> | 0 | 0 | 0 |
| 0 | 0 | 0 | | |
| <p>4) Enter the primary code to be deleted.</p> <ul style="list-style-type: none"> • The Mode indicator will flash red. | <p>Mode  Door  Orange</p> <p>Red Orange</p> | | | |
| <p>5) Enter your programming code to confirm the deletion.</p> <p>If the programming code is valid, three beeps will be heard and the controller will return to its normal mode.</p> <p>If the programming code is invalid, a long beep will be heard and the controller will return to its normal mode.</p> | | | | |



4.14 RELAY CODES ASSIGNMENT

When a primary code is enrolled for any user, the user is authorized to activate the Lock Strike relay. However, different user codes may be set to operate the auxiliary relay instead or operate both the Lock strike and auxiliary relay. Assignment of such codes is achievable for any valid user code entered in the controller.

There are two methods to assign relay codes to users: a standard method and a search method.





4.14.1 Relay Code Assignment using Standard Method



- 1) Enter the programming mode. Mode  Door
Green
- 2) Depress 9 to enter Menu 9.
 - The Mode indicator will turn green. Mode   Door
 - The Door indicator will turn orange. Green Orange
- 3) Enter the 3-digit user slot for code assignment.
 - The Door indicator will flash green. Mode   Door
Green Orange
- 4) Enter the assignment digit for the current user slot:
 - 1 will activate the Lock Strike relay only default
 - 2 will activate the Auxiliary relay only
 - 3 will activate the Lock Strike and Auxiliary relays.

If the assignment code is valid, the Mode indicator will stop flashing. Mode   Door
Green Orange



The controller is now waiting for another slot number. Depress the # key to move to the next slot or enter a new slot number. If you do not wish to continue, depress the # key twice and the controller will return to its normal mode.

4.14.2 Relay Code Assignment using Search Method

- 1) Enter the programming mode. Mode   Door
Green
- 2) Depress 9 to enter Menu 9.
 • The Mode indicator will turn green. Mode   Door
 • The Door indicator will turn orange. Green Orange

- 3) Enter 000 for user slot access. 0 0 0
- The Door indicator will flash orange. Mode   Door
Green Orange

The controller is now waiting for the primary code of the user.

- 4) Enter the primary code belonging to the user. Mode   Door
Green Orange
- The Mode indicator will flash green.

- 5) Enter the assignment digit for the current user slot:
- 1 will activate the Lock Strike relay only default
 - 2 will activate the Auxiliary relay only
 - 3 will activate the Lock Strike and Auxiliary relays.

If the assignment digit is *valid*, three beeps will be heard and the controller will return to its normal mode.

If the assignment digit is *invalid*, a long beep will sound and the controller will wait for another assignment digit to be entered.

4.15 PIN CODE LENGTH / FACTORY DEFAULT SETTINGS



**Warning:**

You must be very careful before using this command! Changing the pin code length will also erase the entire memory contents, including all user and special codes, and return all codes to their factory-default settings

- 1) Enter the programming mode. **Mode** **Green** **Door**
Green
- 2) Select the desired pin code length as follows:
 - a. 00 - Returns to factory defaults and sets a 4 digit code.
 - b. 05 - Returns to factory defaults and sets a 5 digit code.
 - c. 06 - Returns to factory defaults and sets a 6 digit code.
 - d. 08 - Returns to factory defaults and sets a 4-8 digit code.

**Note:**

When choosing the 4-8 option, please note that you should either enter zeros before the code, or press pound at the end (for example if your code is **12345**, enter either **00012345** or **12345#**).

- Both the Mode and Door indicators **Mode**  **Door** 
will flash red. **Red** **Red**
- 3) Enter your programming code.

If the programming code is *valid*, all memory will be erased, you will hear three beeps and the controller will return to normal mode

If the programming code is *invalid* you will hear a long beep and the controller will return to normal mode, without erasing the memory contents.

4.16 REPLACING A PROGRAMMING CODE

**Note:**

The controller must be in its normal mode for the procedure to work. Insure that the Mode indicator is green before proceeding.

- 1) Remove power from the controller.
- 2) Depress and hold the REX pushbutton.
- 3) Apply power to the unit with the REX pushbutton depressed.
- 4) Release the REX pushbutton.
- 5) You now have 15 seconds to program a new programming code into the unit using the initial default code, before the controller reverts to the existing code.
the default code depends on the pin length selected, refer to the programming Menu table on page 27.

4.17 REPLACING A NORMAL/SECURE CODE

**Note:**

The controller must be in its secure mode for the procedure to work. Insure that the Mode indicator is red before proceeding.

- 1) Remove power from the controller.
- 2) Depress and hold the REX pushbutton.
- 3) Apply power to the unit with the REX pushbutton depressed.
- 4) Release the REX pushbutton.
- 5) You now have 15 seconds to use the normal/secure code to return to the normal mode. Once in the normal mode, enter the programming mode to program a new normal/secure code. the default code depends on the pin length selected, refer to the programming Menu table on page 27.

Appendix A. Limited Warranty

ROSSLARE ENTERPRISES LIMITED (Rosslare) TWO and/or FIVE YEAR LIMITED WARRANTY is applicable worldwide. This warranty supersedes any other warranty. Rosslare's TWO and/or FIVE YEAR LIMITED WARRANTY is subject to the following conditions:

Warranty

Warranty of Rosslare's products extends to the original purchaser (Customer) of the Rosslare product and is not transferable.

Products Covered By This Warranty and Duration

ROSSLARE ENTERPRISES LTD. AND / OR SUBSIDIARIES (ROSSLARE) warrants that the AC-Qx, metal stand alone controller family as listed above, to be free from defects in materials and assembly in the course of normal use and service. The warranty period commences with the date of shipment to the original purchaser and extends for a period of 2 years (24 Months) for models AC-Q41H, AC-Q41HB, AC-Q42H and AC-Q42HB and 5 years (60 months) for models AC-Q41SB, AC-Q42SB and AC-Q44.

Warranty Remedy Coverage

In the event of a breach of warranty, ROSSLARE will credit Customer with the price of the Product paid by Customer, provided that the warranty claim is delivered to ROSSLARE by the Customer during the warranty period in accordance with the terms of this warranty. Unless otherwise requested by ROSSLARE ENTERPRISES LTD. AND / OR SUBSIDIARIES representative, return of the failed product(s) is not immediately required. If ROSSLARE has not contacted the Customer within a sixty (60) day holding period following the delivery of the warranty claim, Customer will not be required to return the failed product(s). All returned Product(s), as may be requested at ROSSLARE ENTERPRISES LTD. AND /OR SUBSIDIARY'S sole discretion, shall become the property of ROSSLARE ENTERPRISES LTD. AND /OR SUBSIDIARIES. To exercise the warranty, the user must contact Rosslare Enterprises Ltd. to obtain an RMA number after which, the product must be returned to the Manufacturer freight prepaid and insured.

In the event ROSSLARE chooses to perform a product evaluation within the sixty (60) day holding period and no defect is found, a minimum US\$ 50.00 or equivalent charge will be applied to each Product for labor required in the evaluation.

Rosslare will repair or replace, at its discretion, any product that under normal conditions of use and service proves to be defective in material or workmanship. No charge will be applied for labor or parts with respect to defects covered by this warranty, provided that the work is done by Rosslare or a Rosslare authorized service center.

Limited Warranty

Exclusions and Limitations

ROSSLARE shall not be responsible or liable for any damage or loss resulting from the operation or performance of any Product or any systems in which a Product is incorporated. This warranty shall not extend to any ancillary equipment not furnished by ROSSLARE, which is attached to or used in conjunction with a Product, nor to any Product that is used with any ancillary equipment, which is not furnished by ROSSLARE.

This warranty does not cover expenses incurred in the transportation, freight cost to the repair center, removal or reinstallation of the product, whether or not proven defective. Specifically excluded from this warranty are any failures resulting from Customer's improper testing, operation, installation, or damage resulting from use of the Product in other than its normal and customary manner, or any maintenance, modification, alteration, or adjustment or any type of abuse, neglect, accident, misuse, improper operation, normal wear, defects or damage due to lightning or other electrical discharge. This warranty does not cover repair or replacement where normal use has exhausted the life of a part or instrument, or any modification or abuse of, or tampering with, the Product if Product disassembled or repaired in such a manner as to adversely affect performance or prevent adequate inspection and testing to verify any warranty claim.

ROSSLARE does not warrant the installation, maintenance, or service of the Product. Service life of the product is dependent upon the care it receives and the conditions under which it has to operate.

In no event shall Rosslare be liable for incidental or consequential damages.

Limited Warranty Terms

THIS WARRANTY SETS FORTH THE FULL EXTENT OF ROSSLARE ENTERPRISES LTD. AND IT'S SUBSIDIARIES' WARRANTY

THE TERMS OF THIS WARRANTY MAY NOT BE VARIED BY ANY PERSON, WHETHER OR NOT PURPORTING TO REPRESENT OR ACT ON BEHALF OF ROSSLARE.

THIS LIMITED WARRANTY IS PROVIDED IN LIEU OF ALL OTHER WARRANTIES. ALL OTHER WARRANTIES EXPRESSED OR IMPLIED, INCLUDING WITHOUT LIMITATION, IMPLIED WARRANTIES OF MERCHANTABILITY AND FITNESS FOR A PARTICULAR PURPOSE, ARE SPECIFICALLY EXCLUDED.

IN NO EVENT SHALL ROSSLARE BE LIABLE FOR DAMAGES IN EXCESS OF THE PURCHASE PRICE OF THE PRODUCT, OR FOR ANY OTHER INCIDENTAL, CONSEQUENTIAL OR SPECIAL DAMAGES, INCLUDING BUT NOT LIMITED TO LOSS OF USE, LOSS OF TIME, COMMERCIAL LOSS, INCONVENIENCE, AND LOSS OF PROFITS, ARISING OUT OF THE INSTALLATION, USE, OR INABILITY TO USE SUCH PRODUCT, TO THE FULLEST EXTENT THAT ANY SUCH LOSS OR DAMAGE MAY BE DISCLAIMED BY LAW. THIS WARRANTY SHALL BECOME NULL AND VOID IN THE EVENT OF A VIOLATION OF THE PROVISIONS OF THIS LIMITED WARRANTY.

Appendix B. Technical Support

Asia Pacific, Middle East, Africa

Rosslare Security Products Headquarters
905-912 Wing Fat Industrial Bldg,
12 Wang Tai Road,
Kowloon Bay Hong Kong
Tel: +852 2795-5630
Fax: +852 2795-1508
E-mail: support.apac@rosslaresecurity.com

United States and Canada

1600 Hart Court, Suite 103
Southlake, TX, USA 76092
Toll Free: +1-866-632-1101
Local: +1-817-305-0006
Fax: +1-817-305-0069
E-mail: support.na@rosslaresecurity.com

Europe

Global Technical Support & Training Center
HaMelecha 22
Rosh HaAyin, Israel 48091
Tel: +972 3 938-6838
Fax: +972 3 938-6830
E-mail: support.eu@rosslaresecurity.com

South America

Pringles 868, 1640 Martinez
Buenos Aires
Argentina
Tel: +54 11 4798-0095
Fax: +54 11 4798-2228
E-mail: support.la@rosslaresecurity.com

Web Site: www.rosslaresecurity.com

ROSSLARE
SECURITY PRODUCTS

www.rosslaresecurity.com

CE



0706-0960121+02