

Rimlocks



We take the worry out of
protecting what's valuable to you.
Lockwood: *no worries*[®]

LOCKWOOD

ASSA ABLOY

25YEAR

**MECHANICAL
WARRANTY**

www.lockweb.com.au

Contents



001
Deadlatch
page 3



002
Deadlatch
page 8



355
Deadlock
page 14



303
Deadlock
page 16



507
Nightlatch
page 19



509
Nightlatch
page 21



201
Nightlatch
page 23



100
Nightlatch
page 25



211
Streamlatch
page 27

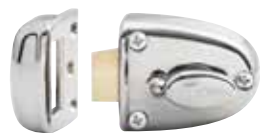

200
Nightlatch
page 29



213
Deadbolt
page 31

001 Double Cylinder Deadlatch



Description

The Australian-designed Lockwood 001® Deadlatch offers market-leading performance and reliability for your home and is available in both Knob and Lever versions.

The 001® Deadlatch features a cut-resistant stainless steel bolt, 11 concealed anchorage points and a door frame strengthener that combine to offer high security protection.

Additional features include a bolt hold back function that allows you to use your door in passage mode.

Features and Specifications

- Bolt hold-back function activated by external key or internal knob
- Can be key locked in hold-back position by key from inside
- Can be keyed alike to other Lockwood door locks
- Available in trade and display pack versions

Keying

- Supplied individually keyed with two keys per lock
- 78,000 key combinations
- Key blank KB2015P

Product Details

Backset	60mm
Case	High purity zinc alloy
Cylinders	Internal and external 5 pin tumbler mechanism. Brass cylinders and brass barrels.
Door Thickness	30 - 45mm
Finish	Gold (GLD) Satin Chrome Pearl (SP) Chrome Plate (CP) Brown (BRN) Everbrass (EVB)
Latch	Stainless steel 18mm projection
Packers	3mm thick packer plates are available, these packers are installed under lock body to align lock body with face of jamb

Restricted Special Keying

Lockwood locks can be keyed to a number of controlled and/or specially keyed systems. These range from legally protected keys to protect against unauthorised duplication, which can also include specially designed key systems such as master key systems, which allow for different levels of mechanical access control.

Please refer to Lockwood Keying Catalogue or contact your local sales office or customer service for specific information.

Standards and Compliance

Conforms to Australian Standard (AS4145.2-2008 S,7D8C6)

Retrofitable

Replace your existing 001 Deadlatch™.

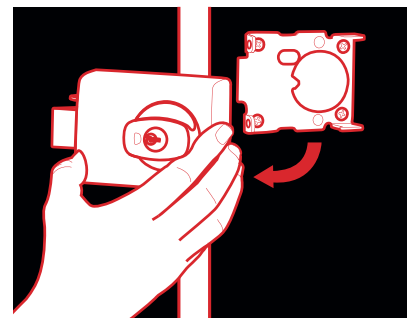

001 Double Cylinder Deadlatch

Double Cylinder with Knob

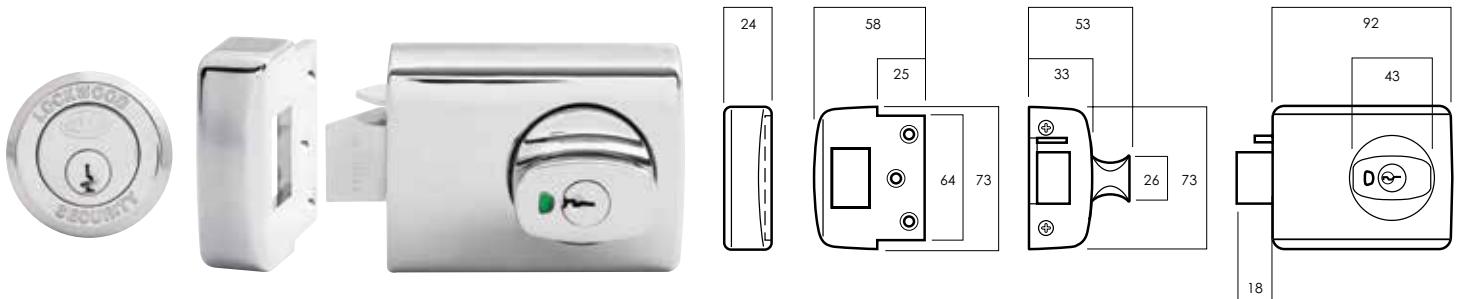

Exterior Cylinder

Interior



Kinetic Defence®
Bump and pick resistant.



2 Keys Included
Can be keyed alike to other
Lockwood door locks.



SafetyRelease™
Minimises the risk of being
locked in.



Retrofitable
Replace your existing
001 Deadlatch™.



LockAlert®
Interior Indicator shows lock
status at a glance.



Safety Mode
Securely locked from outside
and free from inside.



Secure Mode
Securely locked from both
inside and outside. For when
nobody is home.



Passage Mode
Free to enter from outside
and free to exit from inside.



Deadlatch Bolt
Stainless steel 18mm projection.

001 Double Cylinder Deadlatch

001 - 1K1 with Open In Strike - Single Pack

Finish	Trade Pack	Display Pack
Gold	001-1K1GLD	001-1K1GLDDP
Satin Chrome Pearl	001-1K1SP	001-1K1SPDP
Chrome Plate	001-1K1CP	001-1K1CPDP
Brown	—	001-1K1BRNDP
Everbrass	001-1K1EVB	001-1K1EVBDP

Description

Suitable for INWARD opening timber framed doors.

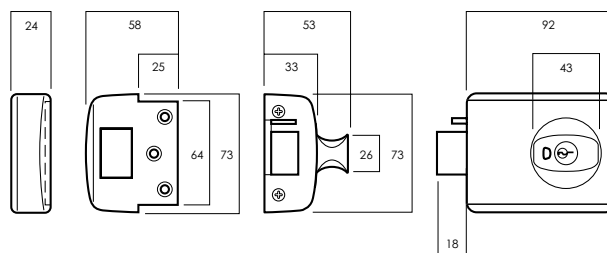

001 - 1K2 with Open In Strike - Twin Pack

Finish	Trade Pack	Display Pack
Gold	—	001-1K2GLDDP
Satin Chrome Pearl	001-1K2SP	001-1K2SPDP
Bright Chrome	—	001-1K2CPDP
Everbrass	—	001-1K2EVBDP

Description

Suitable for INWARD opening timber framed doors. Keyed alike for extra convenience. Pack contains two locksets.

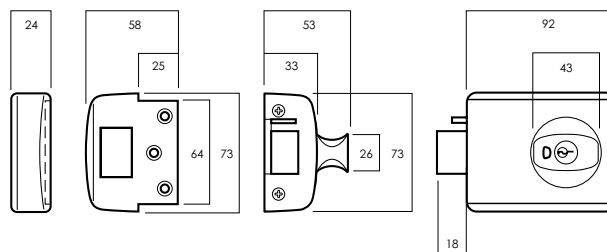

001 - 3K1 with Metal Frame Strike - Single Pack

Finish	Trade Pack
Satin Chrome Pearl	001-3K1SP

Description

Suitable for INWARD opening metal framed doors.

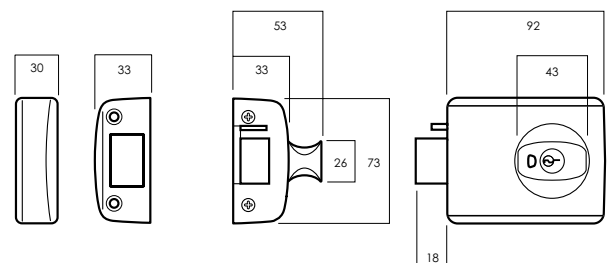

001 - 4K1 with Open Out Strike - Single Pack

Finish	Trade Pack
Satin Chrome Pearl	001-4K1SP

Description

Suitable for OUTWARD opening timber framed doors.

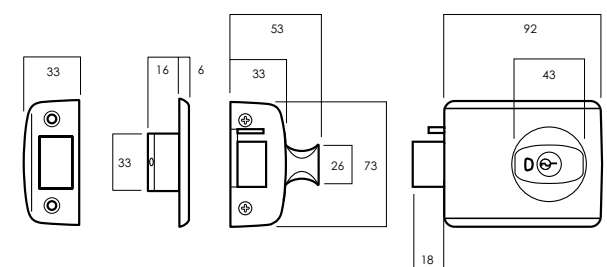

001 Double Cylinder Deadlatch

Double Cylinder with Lever

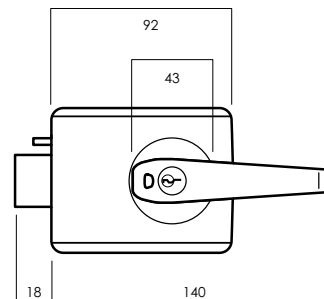

Exterior Cylinder

Interior



Kinetic Defence®
Bump and pick resistant.



2 Keys Included
Can be keyed alike to other
Lockwood door locks.



SafetyRelease™
Minimises the risk of being
locked in.



Retrofitable
Replace your existing
001 Deadlatch™.



LockAlert®
Interior Indicator shows lock
status at a glance.



Safety Mode
Securely locked from outside
and free from inside.



Secure Mode
Securely locked from both
inside and outside. For when
nobody is home.



Passage Mode
Free to enter from outside
and free to exit from inside.



Deadlatch Bolt
Stainless steel 18mm projection.

001 Double Cylinder Deadlatch

001 - 1L1 with Open In Strike - Single Pack

Finish	Trade Pack	Display Pack
Gold	—	001-1K1GLDDP
Satin Chrome Pearl	001-1L1SP	001-1K1SPDP
Chrome Plate	—	001-1K1CPDP
Brown	—	001-1K1BRNDP
Everbrass	—	001-1K1EVBDP

Description

Suitable for INWARD opening timber framed doors.

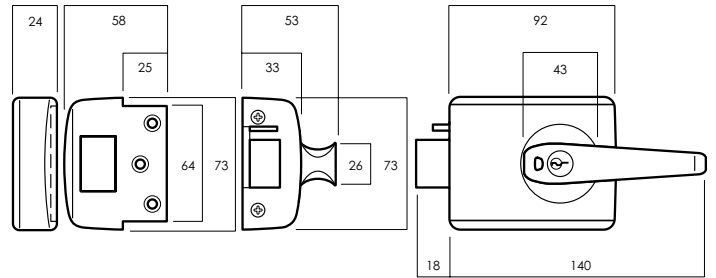

001 - 3L1 with Metal Frame Strike - Single Pack

Finish	Trade Pack
Satin Chrome Pearl	001-3L1SP

Description

Suitable for INWARD opening metal framed doors.

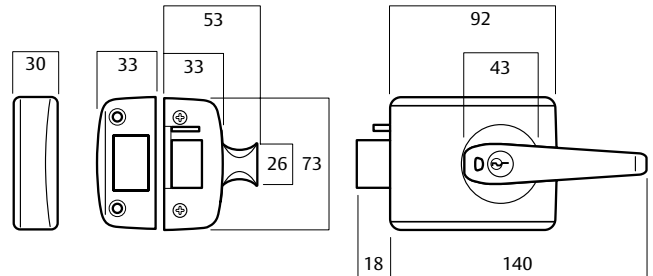

001 - 4L1 with Open Out Strike - Single Pack

Finish	Trade Pack
Satin Chrome Pearl	001-4L1SP

Description

Suitable for OUTWARD opening timber framed doors.

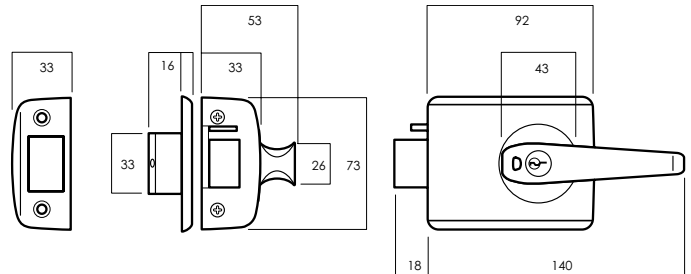

002 Single Cylinder Deadlatch



Description

The Australian-designed Lockwood 002® Deadlatch offers market-leading performance and reliability for your home and is available in both Knob and Lever versions.

The 002® Deadlatch features a cut-resistant stainless steel bolt, 11 concealed anchorage points and a door frame strengthener that combine to offer high security protection.

Additional features include a bolt hold back function that allows you to use your door in passage mode.

Features and Specifications

- High security with cut resistant stainless steel bolt, 11 concealed anchorage points and door frame strengthener
- Bolt hold-back function activated by external key or internal knob
- Can be keyed alike to other Lockwood door locks

Keying

- Supplied individually keyed with two keys per lock
- 78,000 key combinations
- Key blank KB2015P

Product Details

Backset	60mm
Case	High purity zinc alloy
Cylinder	External 5 pin tumbler mechanism. Brass cylinder and brass barrel.
Door Thickness	30 - 45mm
Finish	Gold (GLD) Satin Chrome Pearl (SP) Chrome (CP) Brown (BRN)
Latch	Stainless steel 18mm projection
Packers	3mm thick packer plates are available, these packers are installed under lock body to align lock body with face of jamb

Restricted Special Keying

Lockwood locks can be keyed to a number of controlled and/or specially keyed systems. These range from legally protected keys to protect against unauthorised duplication, which can also include specially designed key systems such as master key systems, which allow for different levels of mechanical access control.

Please refer to Lockwood Keying Catalogue or contact your local sales office or customer service for specific information.

Standards and Compliance

Conforms to Australian Standard (AS4145.2 - 1993)

Retrofitable

Replace your existing 001 Deadlatch™.

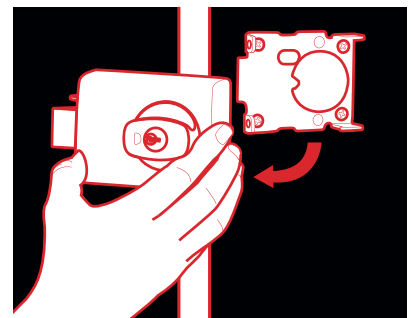

002 Single Cylinder Deadlatch

Single Cylinder with Knob

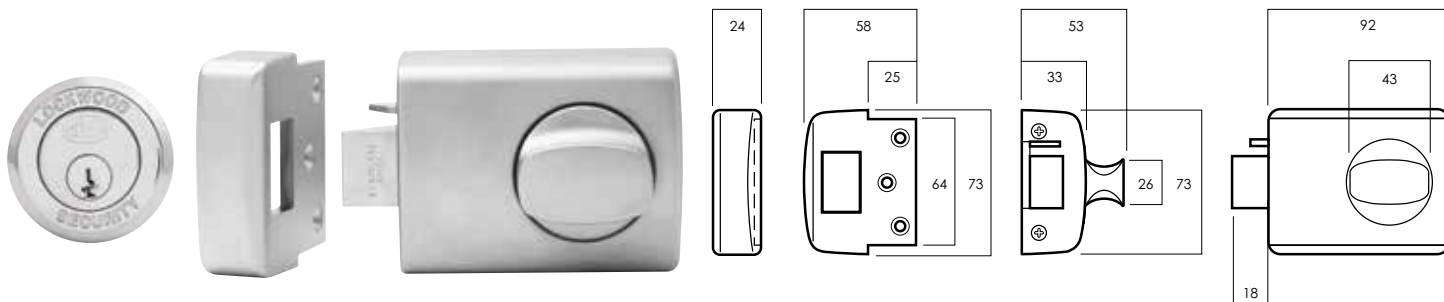

Exterior Cylinder

Interior



Kinetic Defence®
Bump and pick resistant.



SafetyRelease™
Minimises the risk of being locked in.



2 Keys Included
Can be keyed alike to other Lockwood door locks.



Retrofitable
Replace your existing 001 Deadlatch™.



Deadlatch Bolt
Stainless steel 18mm projection.

002 Single Cylinder Deadlatch

002 - 1K1 with Open In Strike - Single Pack

Finish **Trade Pack**

Satin Chrome Pearl 002-1K1SP

Description

Suitable for INWARD opening timber framed doors.

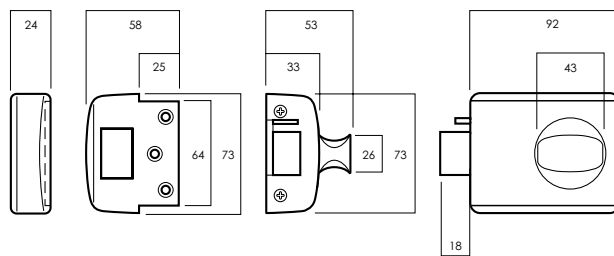

002 - 3K1 with Metal Frame Strike - Single Pack

Finish **Trade Pack**

Satin Chrome Pearl 002-3K1SP

Description

Suitable for INWARD opening metal framed doors.

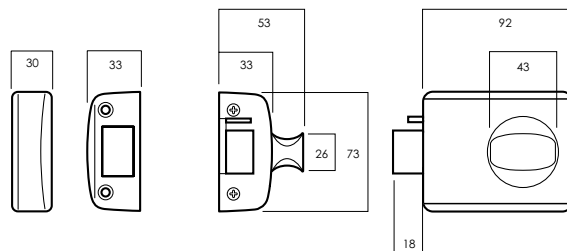

002 - 4K1 with Open Out Strike - Single Pack

Finish **Trade Pack**

Satin Chrome Pearl 002-4K1SP

No Cylinder

Satin Chrome Pearl 002-4KSPNC

Description

Suitable for OUTWARD opening timber framed doors.

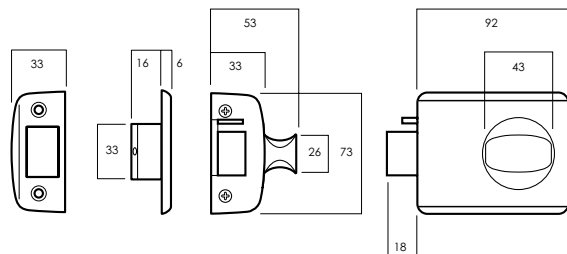

002 Single Cylinder Deadlatch

Single Cylinder with Lever

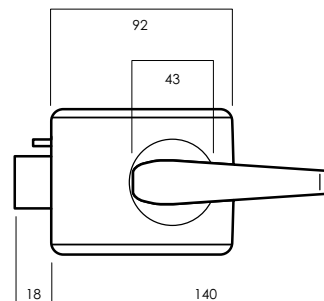
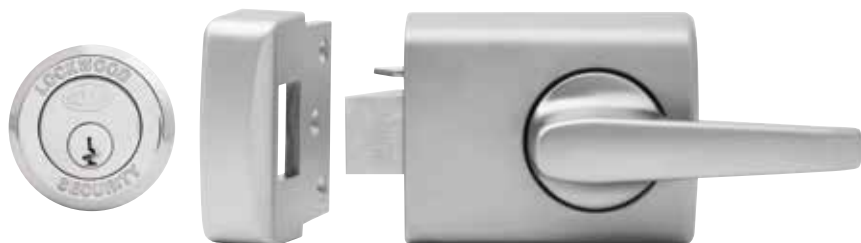

Exterior Cylinder

Interior



Kinetic Defence®
Bump and pick resistant.



SafetyRelease™
Minimises the risk of being locked in.



2 Keys Included
Can be keyed alike to other Lockwood door locks.



Retrofitable
Replace your existing 001 Deadlatch™.



Deadlatch Bolt
Stainless steel 18mm projection.

002 Single Cylinder Deadlatch

Product Details

Finish **Trade Pack**

Satin Chrome Pearl 002-1L1SP

Description

Suitable for INWARD opening timber framed doors.

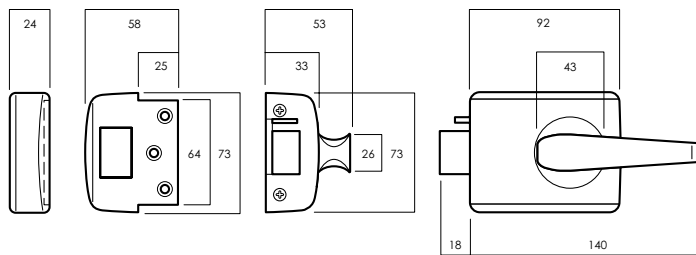

Product Details

Finish **Trade Pack**

Satin Chrome Pearl 002-3L1SP

Description

Suitable for INWARD opening metal framed doors.

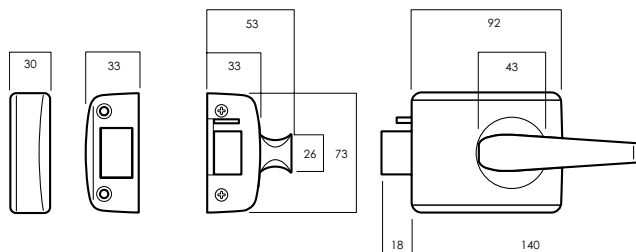

Product Details

Finish **Trade Pack**

Satin Chrome Pearl 002-4L1SP

No Cylinder

Satin Chrome Pearl 002-4L1SPNC

Description

Suitable for OUTWARD opening timber framed doors.

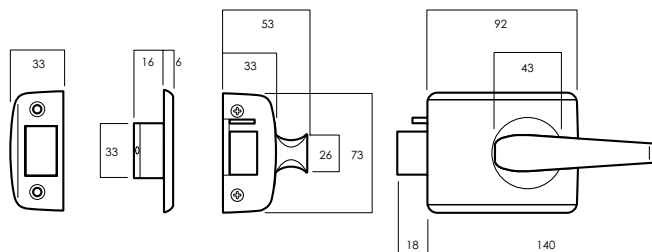

002 Single Cylinder Deadlatch - Accessories

Packer Plate

Finish	Trade Pack
Black	001-3254BLK

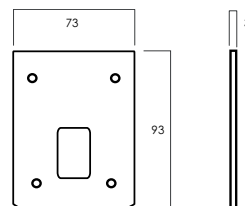

Retrofit 31mm Strike

Finish	Trade Pack
Gold	001-3653GLD
Satin Chrome Pearl	001-3653SP
Chrome Plate	001-3653CP
Brown	001-3653BRN

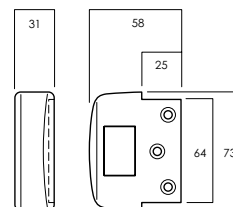

Metal Frame Strike Pack

Finish	Trade Pack
Gold	001-3053GLD
Satin Chrome Pearl	001-3053SP
Chrome Plate	001-3053CP
Brown	001-3053BRN

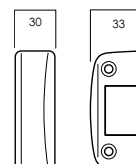

Outward Opening Strike

Finish	Trade Pack
Gold	001-3253GLD
Satin Chrome Pearl	001-3253SP
Chrome Plate	001-3253CP
Brown	001-3253BRN

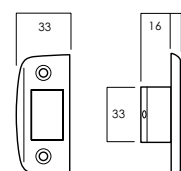

355 Double Cylinder Deadlock



Description

The premium security features provided by the 355 Deadlock make it an ideal lockset for both domestic and commercial applications.

Opened by key from outside and by turn knob from inside when free. Internal key locks or unlocks turn knob.

Features and Specifications

- Suitable for hinged and some sliding doors
- Lockable turn knob with inbuilt clutching device to resist wrench attack
- Strong interlocking case and mounting plate to resist jemmy and hammer attack
- Concealed fixing
- Positive deadlocking action
- The mechanism and the design are protected by Australian and International Patents and Design Registrations

Keying

- Supplied individually keyed with two keys per lock
- 78,000 key combinations
- Key blank KB2015P

Product Details

Backset	60mm
Bolt	Stainless steel
Case	Thick walled, high purity zinc alloy casting
Case Retainer Plate and Operating Mechanism	Solid pressed steel and diecast. Zinc components.
Cylinders	Internal and external 5 pin tumbler mechanism. Brass cylinders and brass barrels.
Door Thickness	30 - 45mm
Finish	Everbrass (EVB) Satin Chrome Pearl (SP) Chrome Plate (CP) Brown (BRN)
Mounting Plate and Strike	Pressed steel
Packers	3mm thick packing plates installed under lock body to align lock body with face of jamb
Strike Conversion Plate	A strike conversion plate is required where the strike is to be installed in place of an existing flange strike

Standards and Compliance

Conforms to Australian Standard (AS4145.2 - 2008 | SL7D8C6)

Restricted Special Keying

Lockwood locks can be keyed to a number of controlled and/or specially keyed systems. These range from legally protected keys to protect against unauthorised duplication, which can also include specially designed key systems such as master key systems, which allow for different levels of mechanical access control.

Please refer to Lockwood Keying Catalogue or contact your local sales office or customer service for specific information.

355 Double Cylinder Deadlock

Double Cylinder with Knob

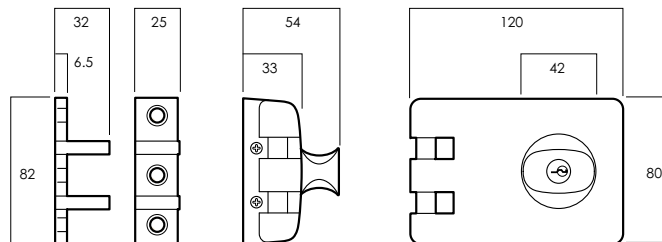

Exterior Cylinder

Interior



Kinetic Defence®
Bump and pick resistant.



2 Keys Included
Can be keyed alike to other Lockwood door locks.



Retrofittable
Replace your existing 001 Deadlatch™.

355 Double Cylinder Deadlock

Finish	Trade Pack	Display Pack
Everbrass	—	355-NEVBDP
Satin Chrome Pearl	355-NSP	355-NSPDP
Chrome Plate	—	355-NCPDP
Brown	—	355-NBRNDP

303 Single Cylinder Deadlock



Description

The security features provided by the 303 Single Cylinder Deadlock make it an ideal lockset for both domestic and commercial applications.

Opened by key from outside and by turn knob from inside.

Features and Specifications

- Suitable for hinged and some sliding doors
- Lockable turn knob with inbuilt clutching device to resist wrench attack
- Strong interlocking case and mounting plate to resist jemmy and hammer attack
- Concealed fixing
- Positive deadlocking action
- The mechanism and the design are protected by Australian and International Patents and Design Registrations

Keying

- Supplied individually keyed with two keys per lock
- 78,000 key combinations
- Key blank KB2015P

Product Details

Backset	60mm
Bolt	Stainless steel
Case	Thick walled, high purity zinc alloy casting. 121mm wide, 76mm high, 56 projection
Case Retainer Plate and Operating Mechanism	Solid pressed steel and diecast. Zinc components.
Cylinder	External 5 pin tumbler mechanism. Brass cylinder and brass barrel.
Door Thickness	30 - 45mm
Finish	Satin Chrome Pearl (SP)
Packers	3mm thick packing plates installed under lock body to align lock body with face of jamb
Strike Conversion Plate	A strike conversion plate is required where the strike is to be installed in place of an existing flange strike
Mounting Plate and Strike	Pressed steel

Standards and Compliance

Conforms to Australian Standard (AS4145.2-1993)

Restricted Special Keying

Lockwood locks can be keyed to a number of controlled and/or specially keyed systems. These range from legally protected keys to protect against unauthorised duplication, which can also include specially designed key systems such as master key systems, which allow for different levels of mechanical access control.

Please refer to Lockwood Keying Catalogue or contact your local sales office or customer service for specific information.

303 Single Cylinder Deadlock

Single Cylinder with Knob

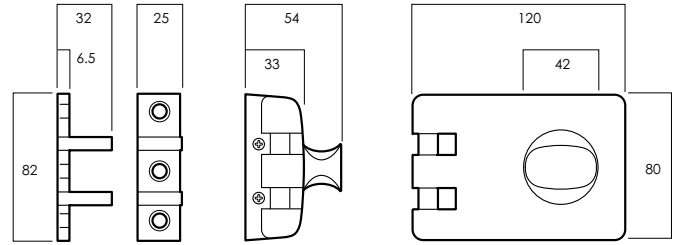

Exterior Cylinder

Interior



Kinetic Defence®
Bump and pick resistant.



2 Keys Included
Can be keyed alike to other
Lockwood door locks.



Retrofittable
Replace your existing
001 Deadlatch™.

303 Double Cylinder Deadlock

Finish	Trade Pack	Display Pack
Satin Chrome Pearl	303-NSP	303-NSPDP
Satin Chrome Pearl	303-NSPNOCYL	

303 Single Cylinder Deadlock - Accessories

3mm Packing Plate

Finish	Trade Pack
Black	335-526BLK

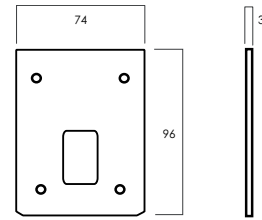

Retrofit Flanged Strike Cover

Finish	Trade Pack
Gold	355-552GLD
Satin Chrome Pearl	355-552SP
Chrome Plate	355-552CP
Brown	355-552BRN

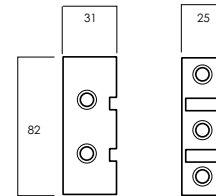

Universal Strike Cover

Finish	Trade Pack
Satin Chrome Pearl	355-152NSP

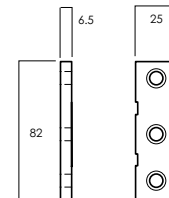

Strike Loops

Finish	Trade Pack
Chrome Plate	355-53NCP
Satin Chrome Pearl	355-53NSP

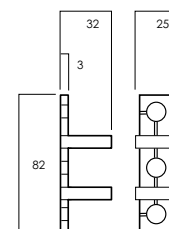

507 Fire Rated Night Latch



Description

The 507 Nightlatch is fire rated to 4 hours, making it the ideal lockset for a range of commercial applications – utility and service cupboards.

Opened by key from outside and by turn knob from inside.

Features and Specifications

- Steel case, strike and latchbolt
- Designed for surface mounting on the inside of outward opening doors
- Available with standard box strike (RBP model) or open out strike (RBS model)
- Latchbolt operated by key from outside and by turn from inside

Keying

Supplied less cylinder

Product Details

Backset	60mm
Case	Steel
Door Thickness	32 - 60mm
Latch	Steel

Note: Cylinder sold separately

Standards and Compliance



The Lockwood 507 Rim Nightlatch has been fire rated up to 4 hours on fire door assemblies in accordance with Australian standard (AS 1905.1:2005), Part 1: Fire Resistant Doorsets

507 Fire Rated Night Latch

507



Interior

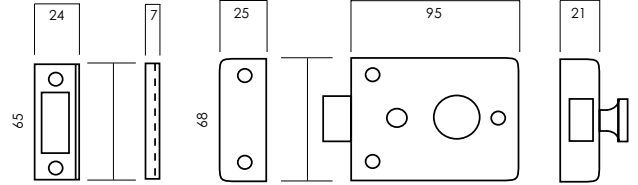

Open Out Strike

Box Strike



Kinetic Defence®
Bump and pick resistant.



2 Keys Included
Can be keyed alike to other Lockwood door locks.



Retrofitable
Replace your existing 001 Deadlatch™.

507 Fire Rated Nightlatch

Finish	Trade Pack	Cylinder
Satin Chrome Pearl	507RBS SP	Cylinder not included with open out strike
Satin Chrome Pearl	507RBP SP	Cylinder not included with box strike
Satin Chrome	201CYLSC	Lockwood standard cylinder

509 Nightlatch



Description

Commercial grade nightlatch with inside snib designed for surface mounting on the inside of outward opening doors.

Opened by key from outside and by turn knob from inside.

Features and Specifications

- Inside snib may be used to hold-back latchbolt
- Steel case and strike
- Available with standard box strike (RBP model) or open out strike (RBS model)
- Bolt hold-back function activated by snib
- Latchbolt operated by key from outside and by turn from inside

Keying

Supplied less cylinder

Product Details

Backset	60mm
Case	Steel
Door Thickness	32 - 60mm
Latch	Brass

Note: Cylinder sold separately

509 Nightlatch

509



Interior

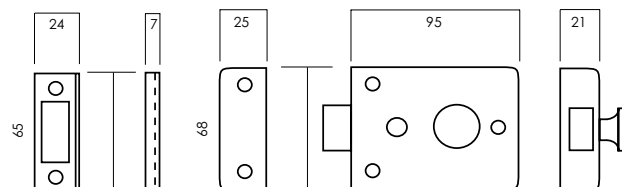

Open Out Strike

Box Strike

509 Nightlatch

Finish	Trade Pack	Cylinder
Satin Chrome Pearl	509RBS SP	Cylinder not included with open out strike
Satin Chrome Pearl	509RBP SP	Cylinder not included with box strike
Satin Chrome	201CYLSC	Lockwood standard cylinder

201 Nightlatch



Description

General purpose nightlatch with inside snib.

Features and Specifications

- Opened by key from outside and by turn knob inside
- Inside snib may be used to hold-back or deadlock bolt, so that key will not operate

Open Out Strike

Part Number SP201-67SC.

Keying

- Supplied individually keyed with two keys per lock
- 78,000 key combinations
- Key blank KB2015P

Restricted Special Keying

Lockwood locks can be keyed to a number of controlled and/or specially keyed systems. These range from legally protected keys to protect against unauthorised duplication, which can also include specially designed key systems such as master key systems, which allow for different levels of mechanical access control.

Please refer to Lockwood Keying Catalogue or contact your local sales office or customer service for specific information.

Product Details

Backset	60mm
Case	High purity zinc alloy. 92mm wide, 64mm high, 43mm projection
Cylinder	5 pin tumbler mechanism. Brass cylinder and brass barrel.
Door Thickness	28 – 45mm
Latch	Brass. Reversible. 13mm projection

201 Nightlatch

201



Exterior Cylinder

Interior

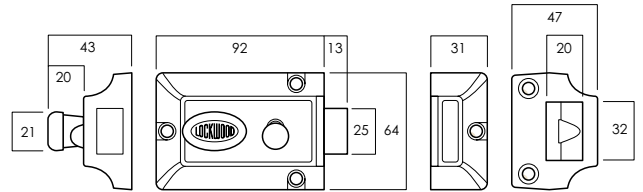

201 Nightlatch

Finish	Trade Pack	Cylinder
Florentine Bronze Cylinder	201FB	201FBDP
Chrome Plate Cylinder	201CP	201CPDP

No Cylinder

Brown	201NOCYL
-------	----------

100 Nightlatch



Description

General purpose nightlatch.

Features and Specifications

- Opened by key from outside and by turn knob inside
- Bolt may be held back by turning knob in clockwise direction

Open Out Strike

Part Number SP201-67SC.

Keying

- Supplied individually keyed with two keys per lock
- 78,000 key combinations
- Key blank KB2015P

Restricted Special Keying

Lockwood locks can be keyed to a number of controlled and/or specially keyed systems. These range from legally protected keys to protect against unauthorised duplication, which can also include specially designed key systems such as master key systems, which allow for different levels of mechanical access control.

Please refer to Lockwood Keying Catalogue or contact your local sales office or customer service for specific information.

Product Details

Backset	60mm
Case	High purity zinc alloy. 92mm wide, 64mm high, 43mm projection
Cylinder	5 pin tumbler mechanism. Brass cylinder and brass barrel.
Door Thickness	28 – 45mm
Latch	Brass. Reversible. 13mm projection

100 Nightlatch

100



Exterior Cylinder

Interior

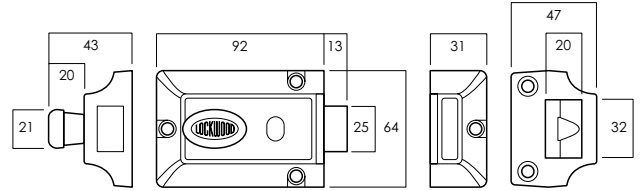

100 Nightlatch

Finish	Trade Pack	Cylinder
Florentine Bronze Cylinder	100FB	100FBDP
Chrome Plate Cylinder	100CP	100CPDP

No Cylinder

Brown	100NOCYL
-------	----------

211 Nightlatch



Description

Medium security general purpose streamlatch.

Features and Specifications

- Opened by key from outside and turn knob inside
- Inside snib may be used to hold-back or deadlock bolt so that key will not operate
- Available in trade pack only

Open Out Strike

Part Number SP201-67SC.

Keying

- Supplied individually keyed with two keys per lock
- 78,000 key combinations
- Key blank KB2015P

Restricted Special Keying

Lockwood locks can be keyed to a number of controlled and/or specially keyed systems. These range from legally protected keys to protect against unauthorised duplication, which can also include specially designed key systems such as master key systems, which allow for different levels of mechanical access control.

Product Details

Backset	60mm
Case	High purity zinc alloy. 92mm wide, 64mm high, 43mm projection
Cylinder	5 pin tumbler mechanism. Brass cylinder and brass barrel.
Door Thickness	28 – 45mm
Latch	Brass. Reversible. 13mm projection

Please refer to Lockwood Keying Catalogue or contact your local sales office or customer service for specific information.

211 Nightlatch

211



Exterior Cylinder



Interior

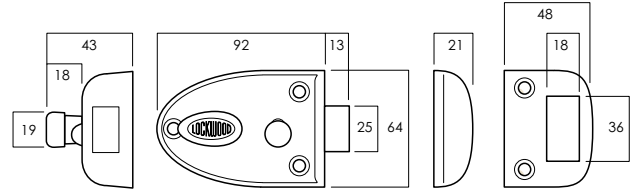

211 Nightlatch

Finish	Trade Pack
Chrome Plate all over	211CPAO
Satin Chrome Pearl all over	211SPA0
No Cylinder	
Satin Chrome Pearl all over	211SPAONOCYL

200 Narrow Stile Streamlatch



Description

General purpose streamlatch designed to suit narrow doors.

Features and Specifications

- Opened by key from outside and turn knob inside
- Inside snib may be used to hold-back or deadlock bolt so that key will not operate

Open Out Strike

Part Number SP201-67SC.

Keying

- Supplied individually keyed with two keys per lock
- 78,000 key combinations
- Key blank KB2015P

Restricted Special Keying

Lockwood locks can be keyed to a number of controlled and/or specially keyed systems. These range from legally protected keys to protect against unauthorised duplication, which can also include specially designed key systems such as master key systems, which allow for different levels of mechanical access control.

Please refer to Lockwood Keying Catalogue or contact your local sales office or customer service for specific information.

Product Details

Backset	38mm for narrow stile doors
Case	High purity zinc alloy. 68mm wide, 57mm high, 43mm projection.
Cylinder	5 pin tumbler mechanism. Brass cylinder and brass barrel.
Door Thickness	28 - 45mm
Latch	Brass. Reversible. 13mm projection.

200 Narrow Stile Streamlatch

200



Exterior Cylinder

Interior

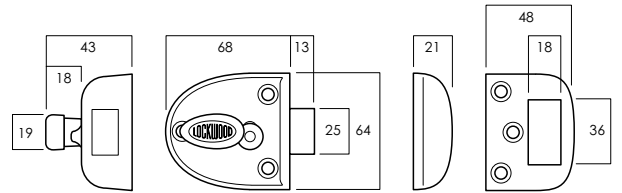

200 Narrow Stile Streamlatch

Finish	Trade Pack
Chrome Plate all over	200CPAO
Satin Chrome Pearl all over	200SPA0
No Cylinder	
Satin Chrome Pearl all over	200SPAONOCYL

213 Streamlock Deadbolt



Description

General purpose deadbolt.

Features and Specifications

- Locked or unlocked by key outside and by turn knob inside

Open Out Strike

Part Number SP201-67SC.

Keying

- Supplied individually keyed with two keys per lock
- 78,000 key combinations
- Key blank KB2015P

Restricted Special Keying

Lockwood locks can be keyed to a number of controlled and/or specially keyed systems. These range from legally protected keys to protect against unauthorised duplication, which can also include specially designed key systems such as master key systems, which allow for different levels of mechanical access control.

Please refer to Lockwood Keying Catalogue or contact your local sales office or customer service for specific information.

Product Details

Backset	60mm
Bolt	Brass. 16mm projection
Case	High purity zinc alloy. 92mm wide, 64mm high, 43mm projection.
Cylinder	5 pin tumbler mechanism. Brass cylinder and brass barrel. Suitable for all cylinder rim locks. Extruded brass cylinder.
Door Thickness	28 - 45mm

213 Streamlock Deadbolt

213



Exterior Cylinder



Interior

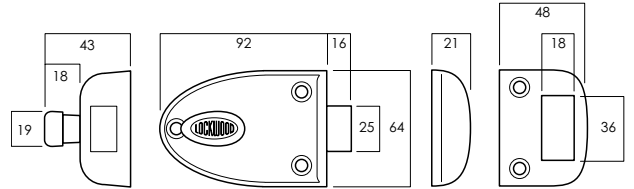

Product Details - 213 Streamlock Deadbolt

Finish Trade Pack

Chrome Plate all over	213CPAO
Satin Chrome Pearl all over	213SPA0

No Cylinder

Satin Chrome Pearl all over	213SPAONOCYL
-----------------------------	--------------

Product Details - 201 Cylinder

Finish	Trade Pack	Display
Chrome Plate	201CYLCP	201CYLCPDP
Satin Chrome Pearl	201CYLSP	201CYLSPDP
Polished Brass	201CYLPBP	—
Florentine Bronze	—	201CYLBBDP

Product Details - 201 Cylinder

Finish	Trade Pack	Display
Satin Chrome Pearl	201-252SP	

Note: Solid Brass Cylinder



ASSA ABLOY

Lockwood is the leading brand in the Australian locking industry. With an established reputation for high quality products, this iconic brand provides a wide range of locking solutions to residential housing, commercial building and industrial application markets. Lockwood is supported by an extensive distribution and after-sales support network. Our customers include retailers, architects, trade and industrial personnel, locksmiths and security dealers.

ASSA ABLOY is the global leader in door opening solutions, dedicated to satisfying end-user needs for security, safety and convenience.

ASSA ABLOY is represented in all major regions, in both mature and emerging markets, with leading positions in Australia, Europe and North America.

25YEAR

**MECHANICAL
WARRANTY**

The Lockwood 25 Year Mechanical Warranty

Our belief that we manufacture the finest premium products available in today's market place is backed by the Lockwood 25 Year Mechanical Warranty, ensuring that Lockwood continues to keep Australians safe by delivering security and peace of mind.

For warranty terms and conditions, please visit www.lockweb.com.au or call **1300WARRANTY**

ASSA ABLOY Australia Pty Ltd
235 Huntingdale Road
Oakleigh, Victoria, 3166
Australia

1300 LOCK UP (1300 562 587)
lockweb.com.au

ASSA ABLOY New Zealand Ltd
6 Armstrong Road
Albany, Auckland, 0632
New Zealand

info.nz@assaabloy.com
Telephone +64 9415 7111
assaabloy.co.nz

